

DEPARTMENT OF PUBLIC WORKS AND PLANNING

BIOLA AVE. - SECTION SHEET 1

DRAWING NO. ### SHEET NO. 1 TOTAL 8

PROJECT

ATP - BIOLA COMMUNITY SIDEWALK

ROAD NO. ### BRIDGE NO. ###

SCALE

HORIZ 0 20' 40'
VERT 0 5 10

DESIGNED: ###	DATE: ###
DRAWN: ###	###
CHECKED: ###	###

THESE CROSS SECTIONS ARE FOR THE CONTRACTOR'S INFORMATION ONLY. THEY ARE NOT TO BE CONSIDERED TO BE PART OF THE CONTRACT DOCUMENTS AND SHALL HAVE NO BEARING WHATSOEVER ON THE INTERPRETATION OF THE STANDARD SPECIFICATIONS, THE STANDARD PLANS, THE SPECIAL PROVISIONS, NOR SHALL THEY HAVE ANY BEARING WHATSOEVER ON THE INTERPRETATION OF THE OTHER PUBLICATIONS REFERENCED THEREIN.

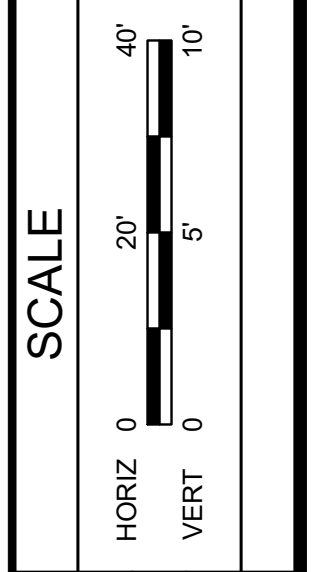
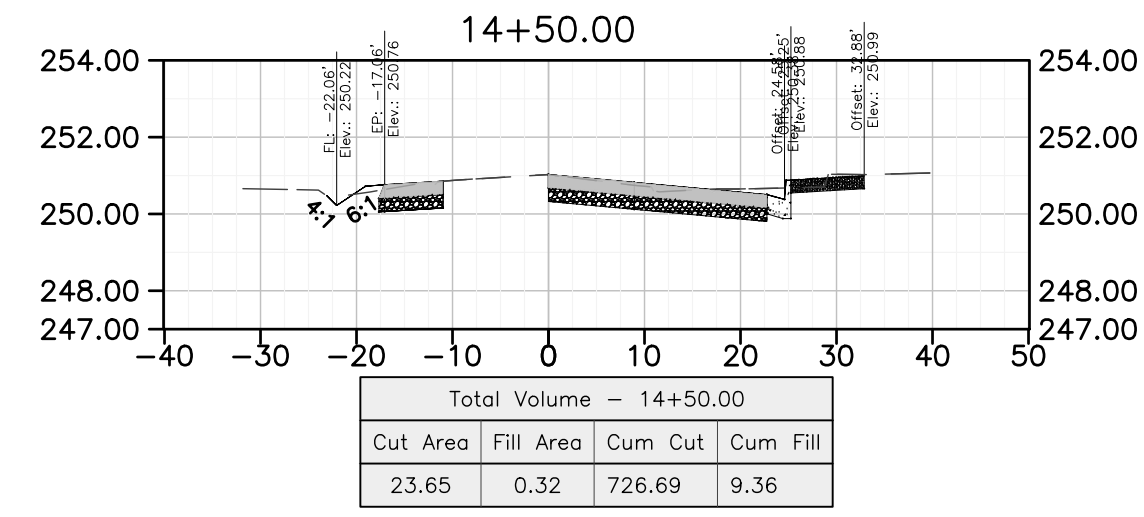
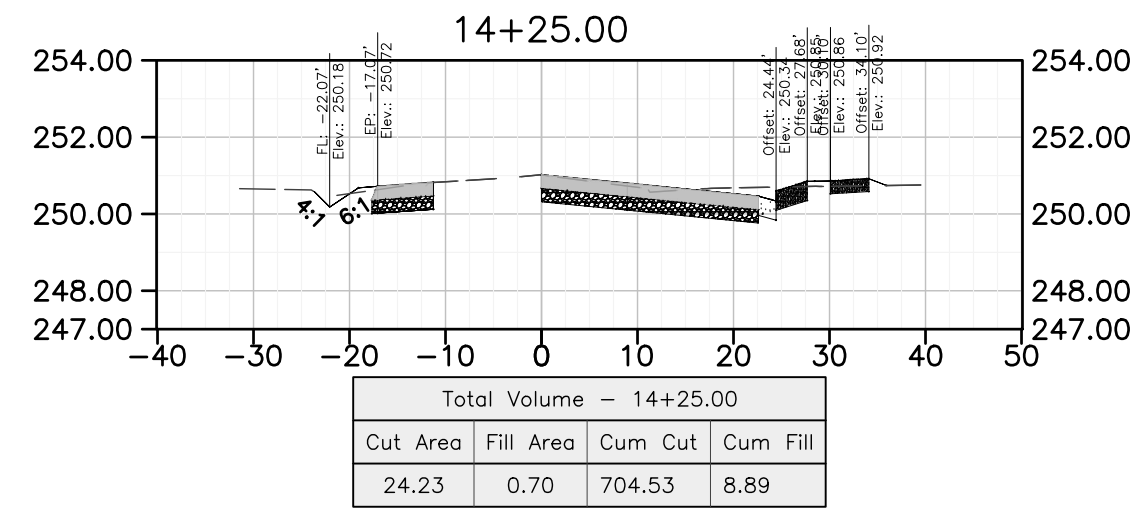
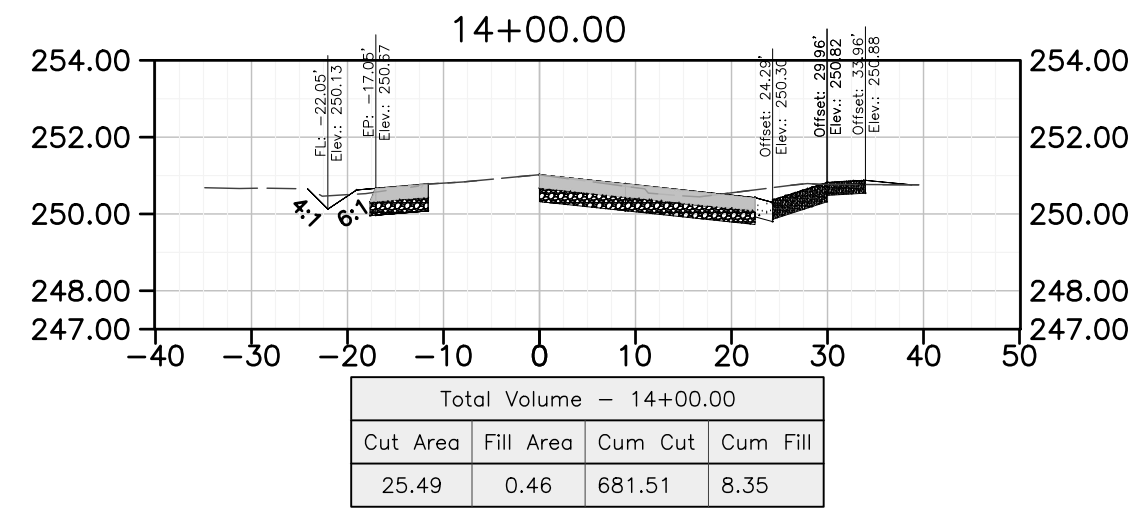
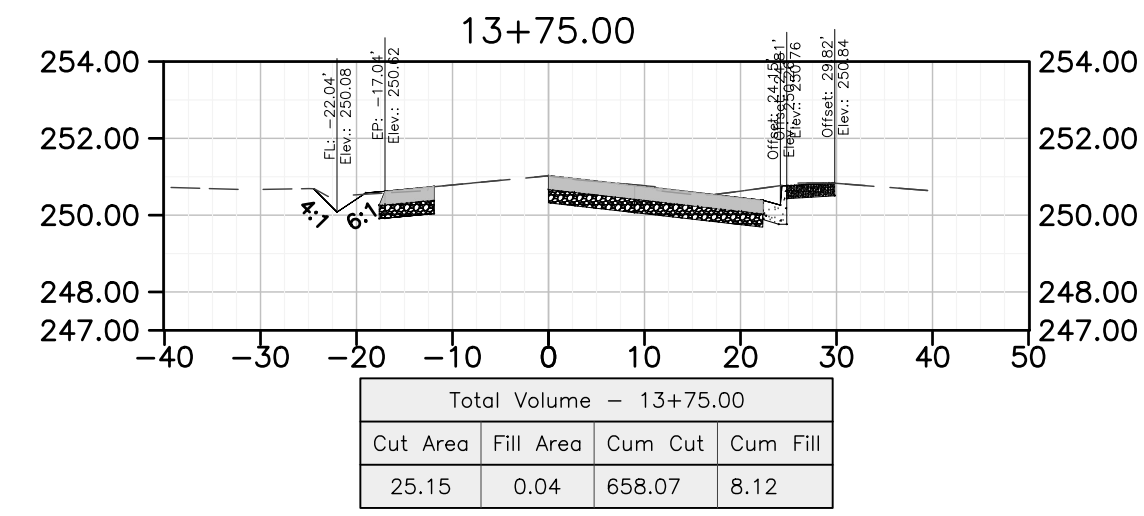
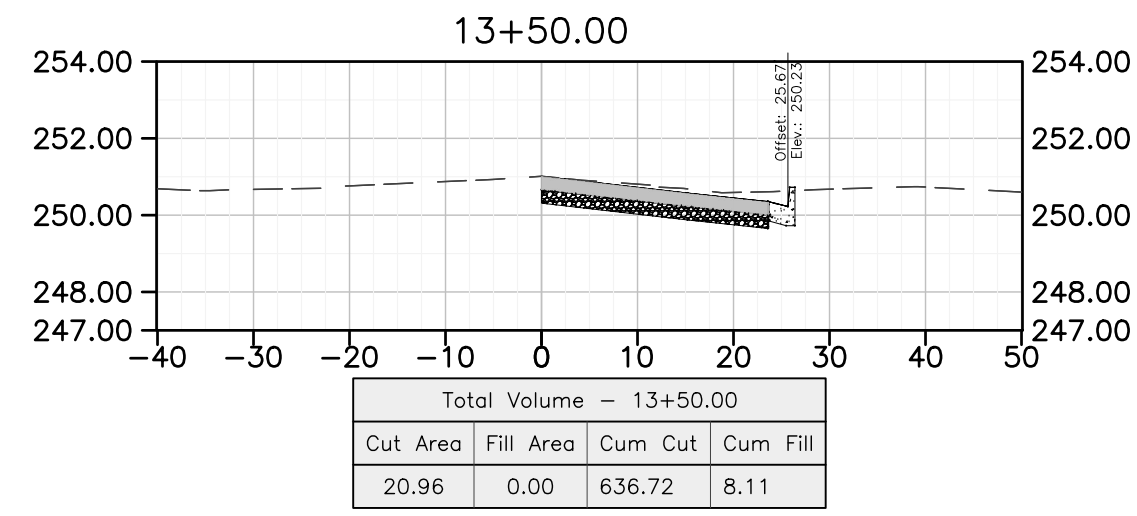
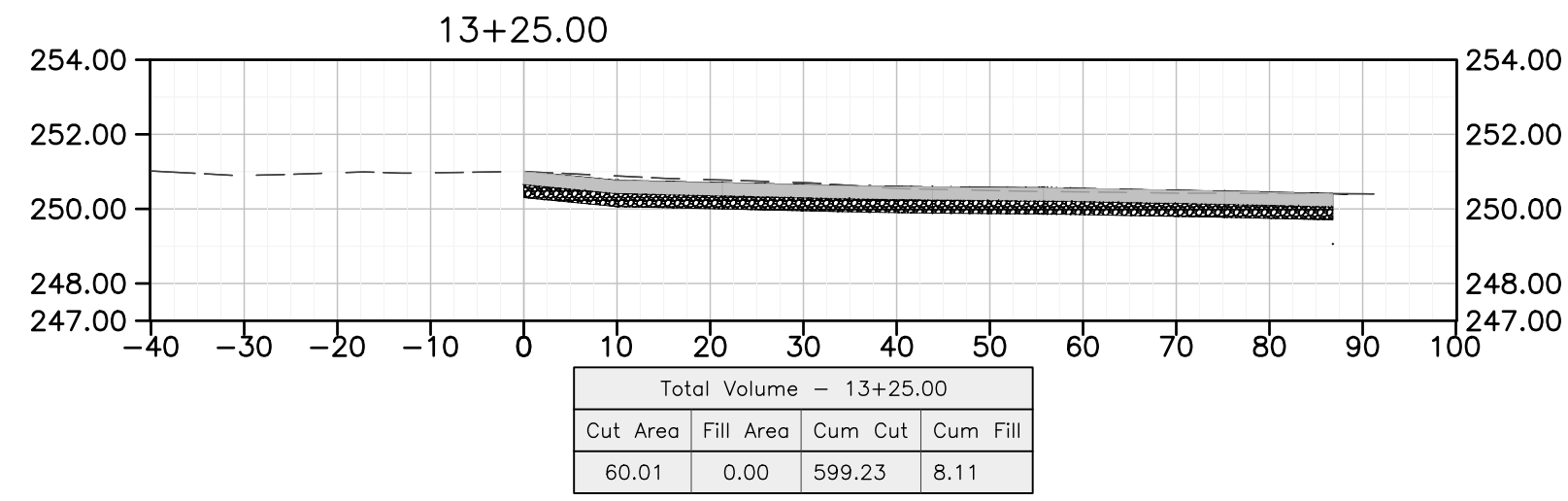
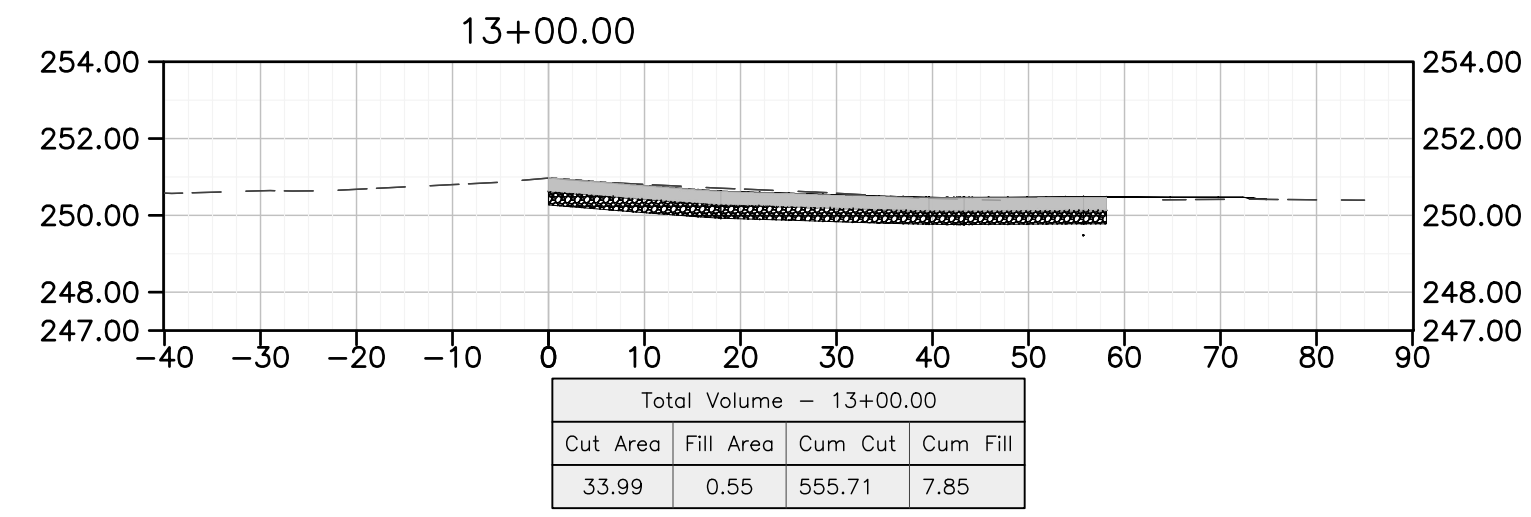
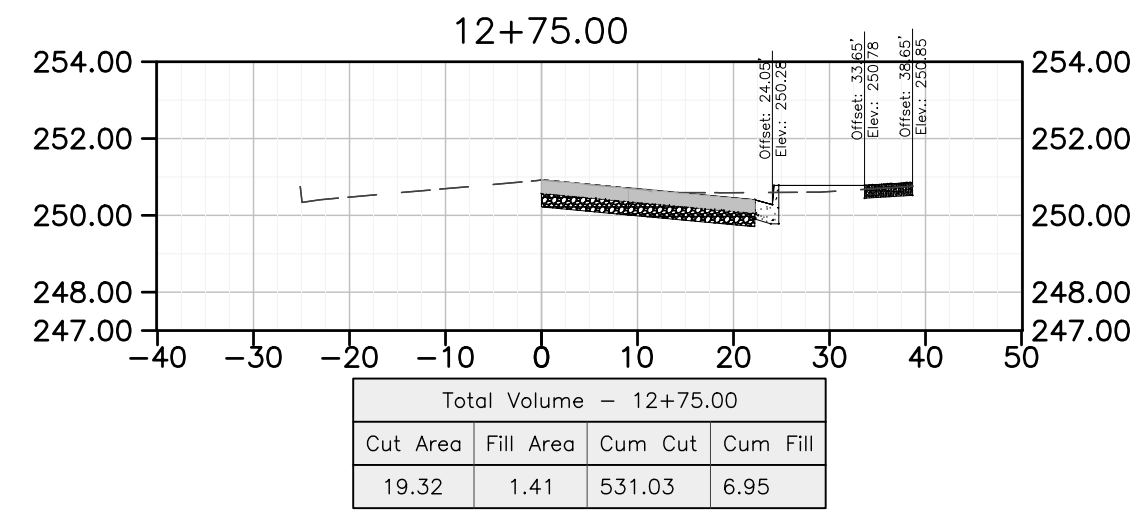
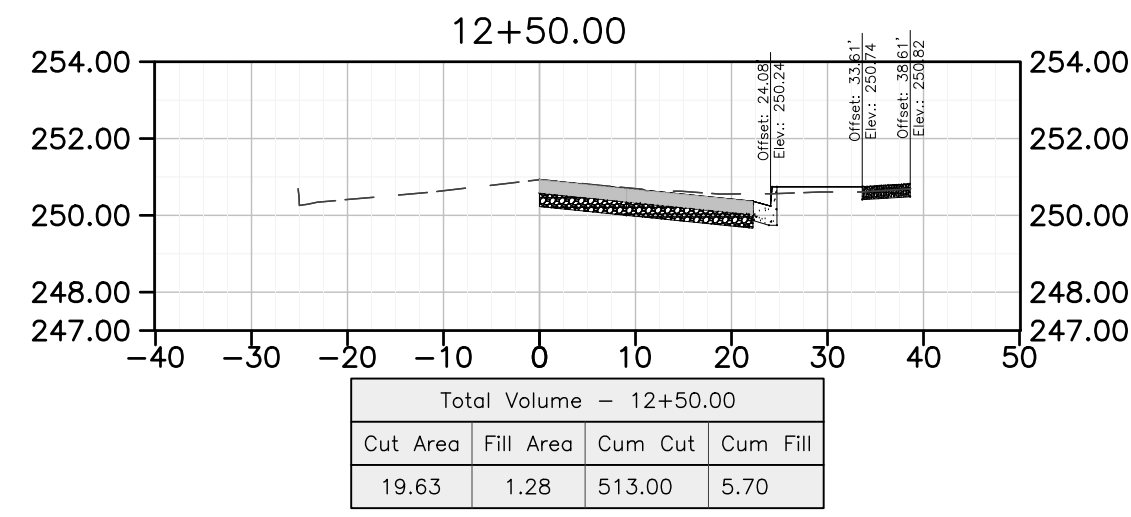
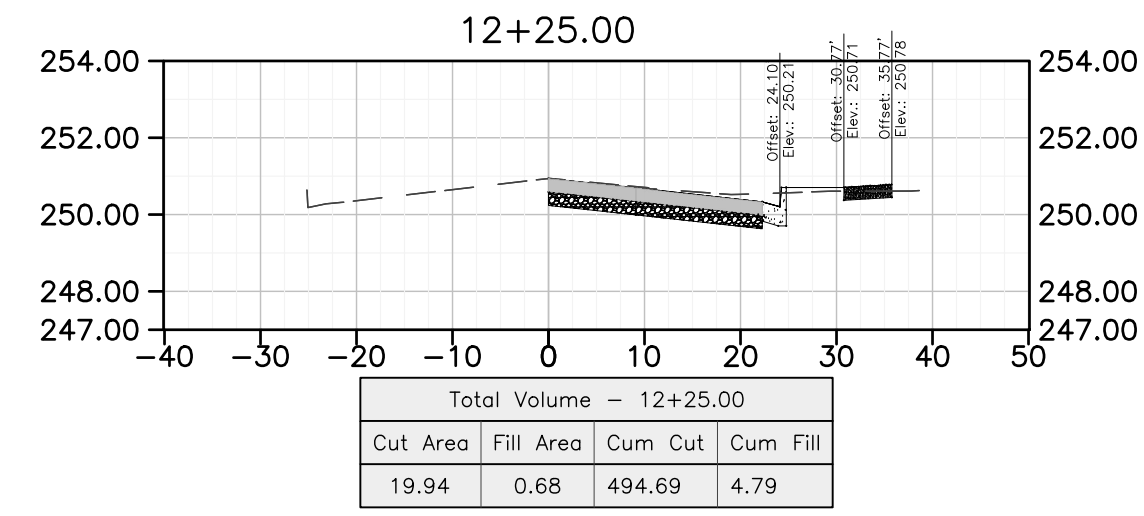
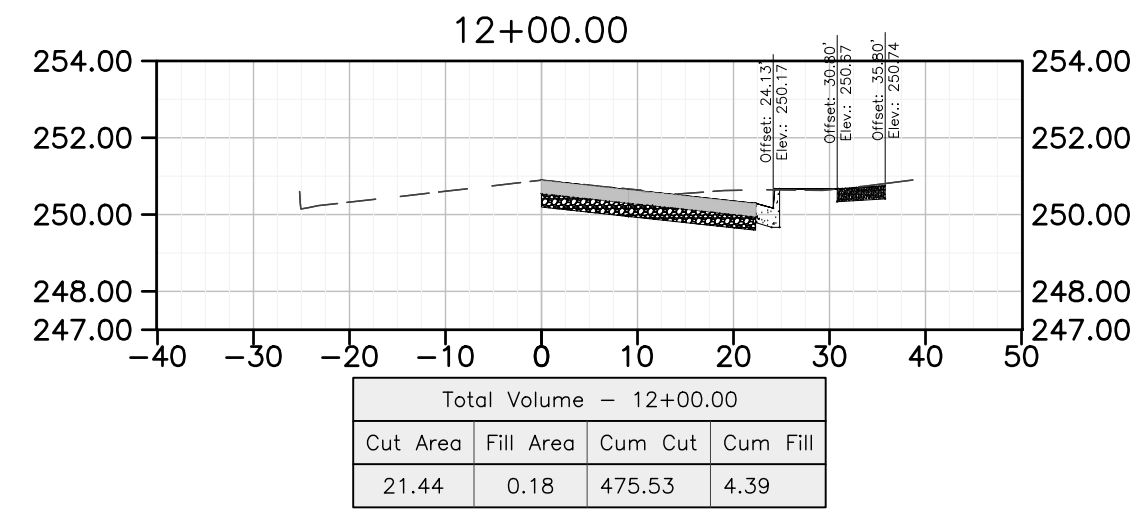
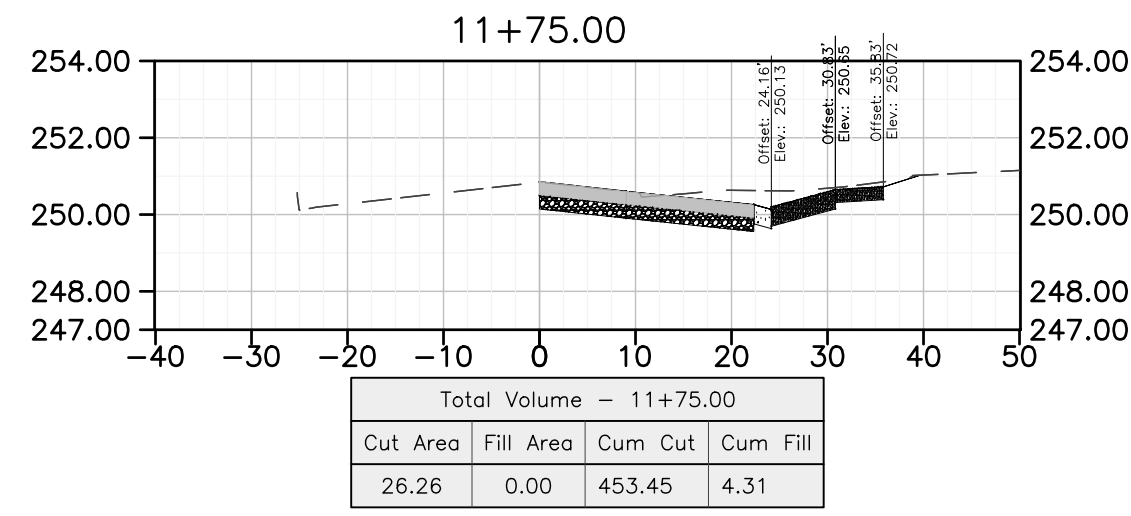

DATE	DESIGNED: ###	DRAWN: ###	CHECKED: ###
###	###	###	###

THESE CROSS SECTIONS ARE FOR THE CONTRACTOR'S INFORMATION ONLY. THEY ARE NOT TO BE CONSIDERED TO BE PART OF THE CONTRACT DOCUMENTS AND SHALL HAVE NO BEARING WHATSOEVER ON THE INTERPRETATION OF THE STANDARD SPECIFICATIONS, THE STANDARD PLANS, THE SPECIAL PROVISIONS, NOR SHALL THEY HAVE ANY BEARING WHATSOEVER ON THE INTERPRETATION OF THE OTHER PUBLICATIONS REFERENCED THEREIN.

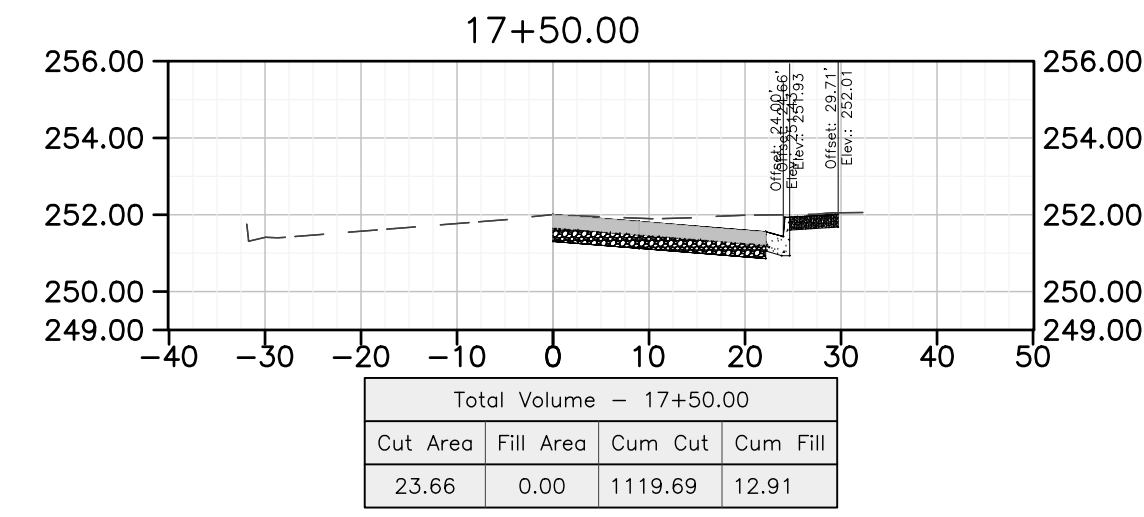
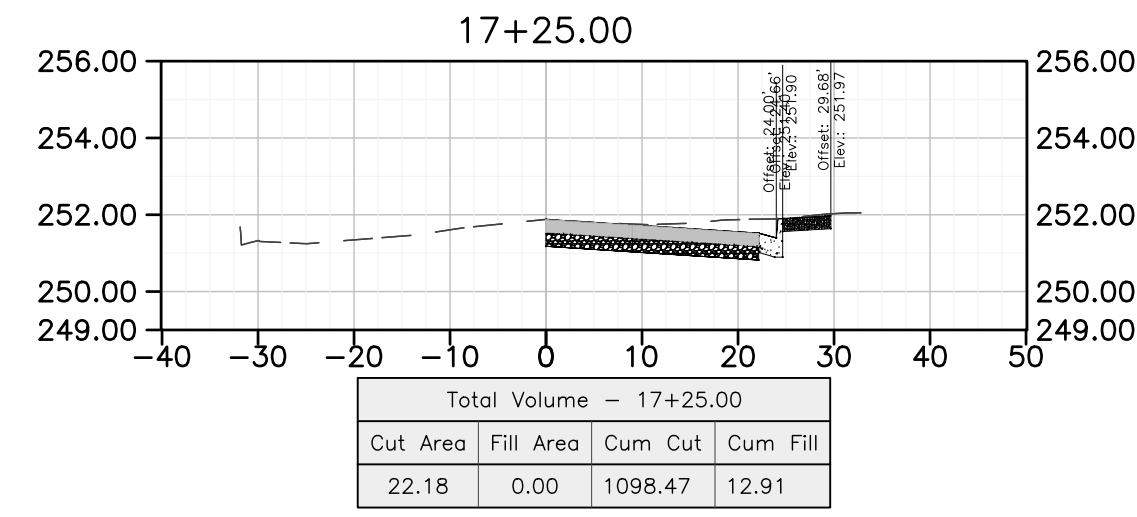
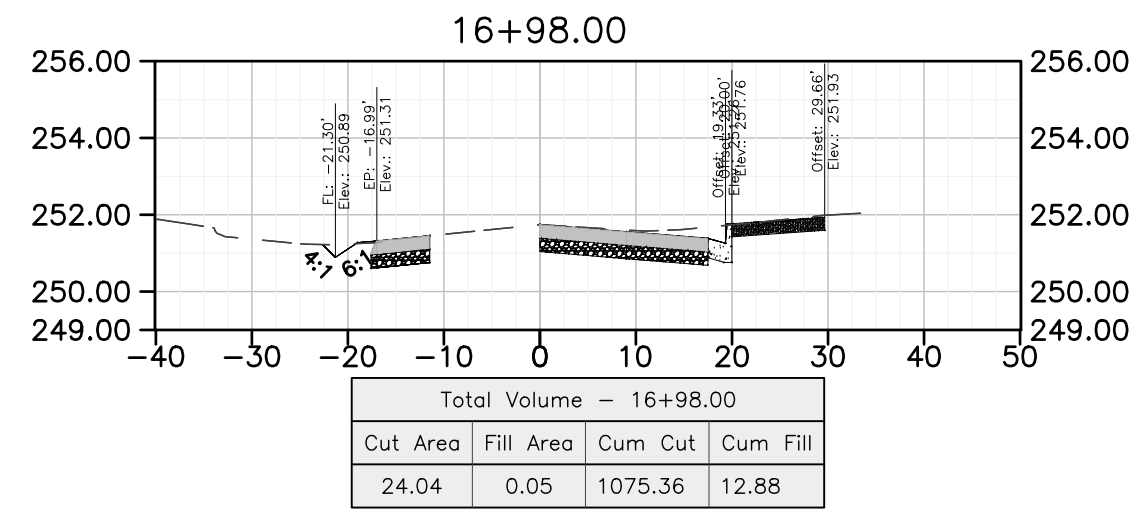
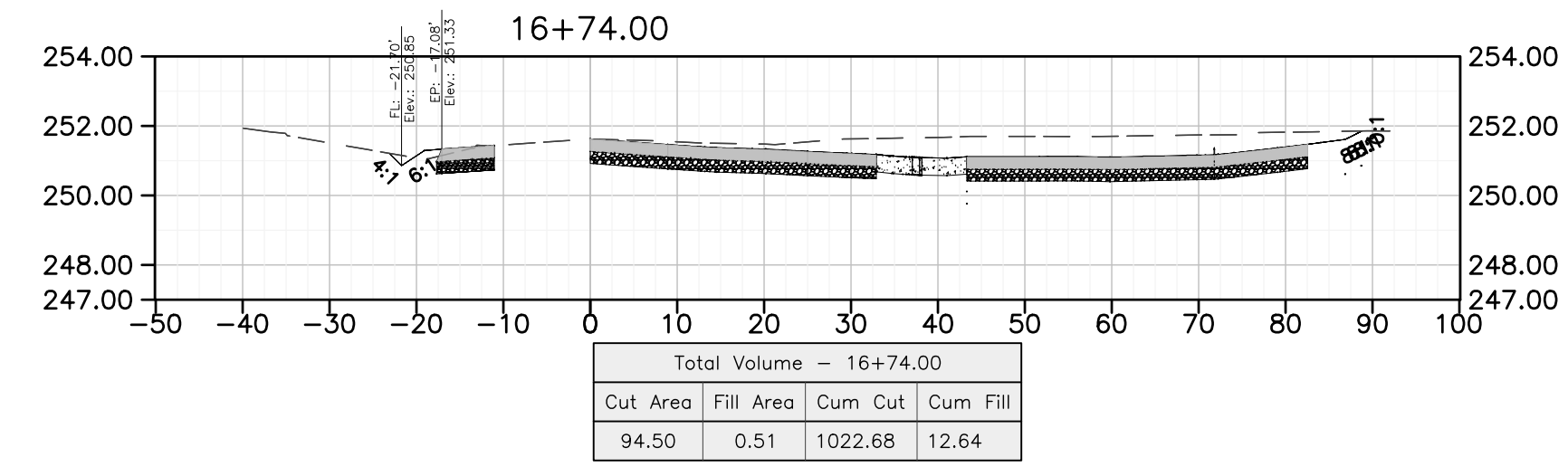
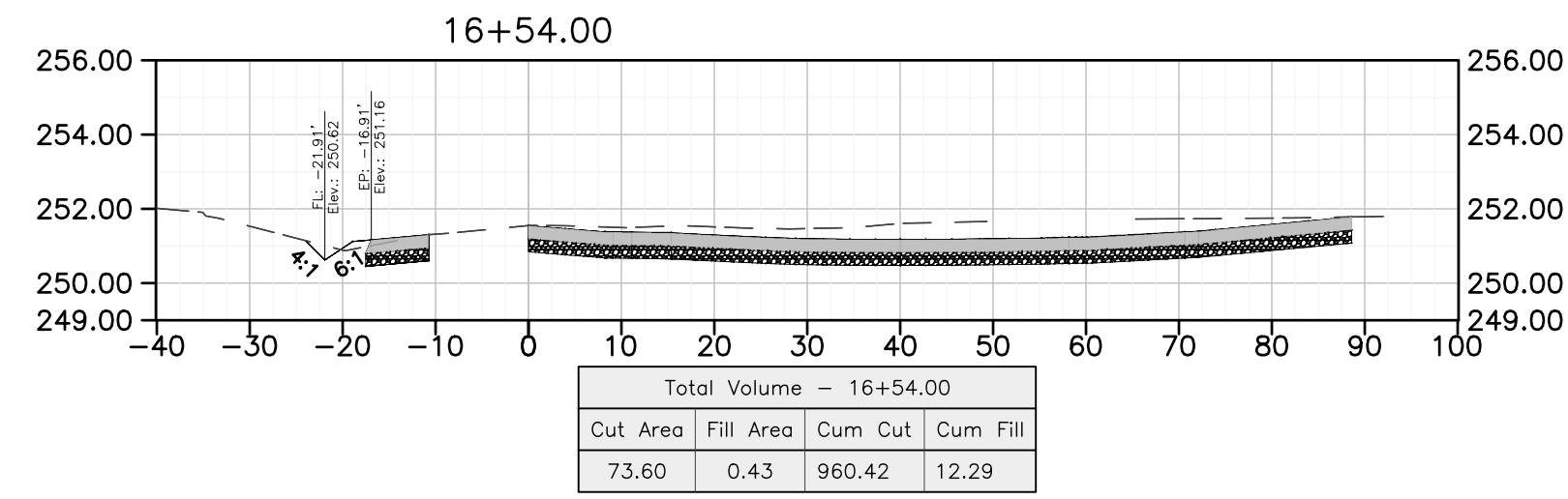
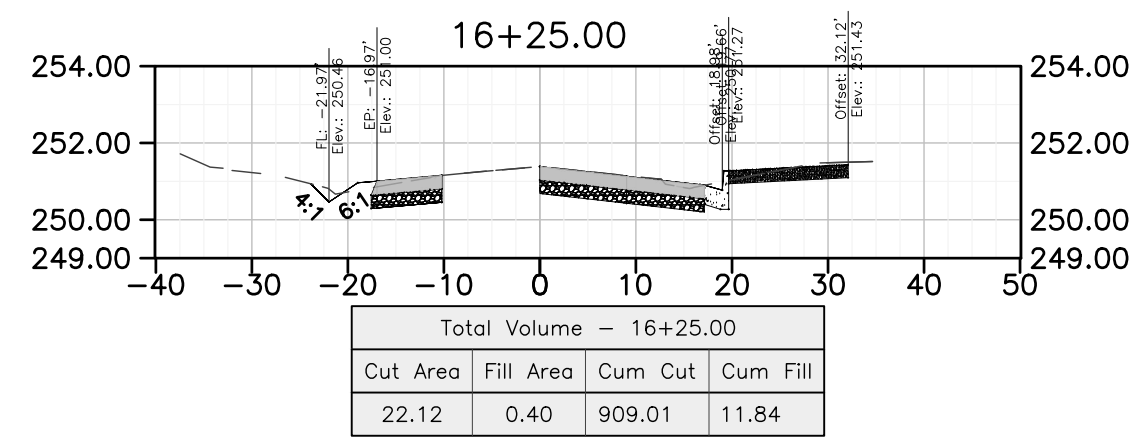
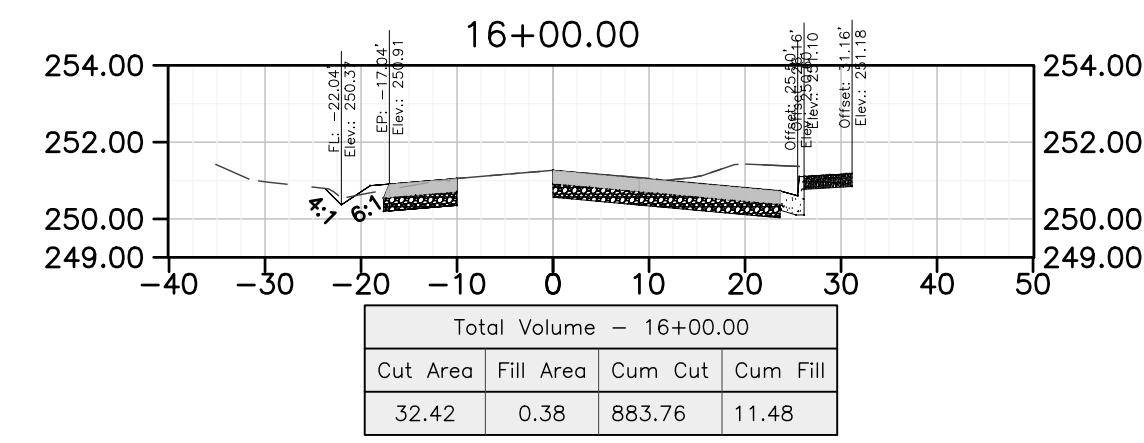
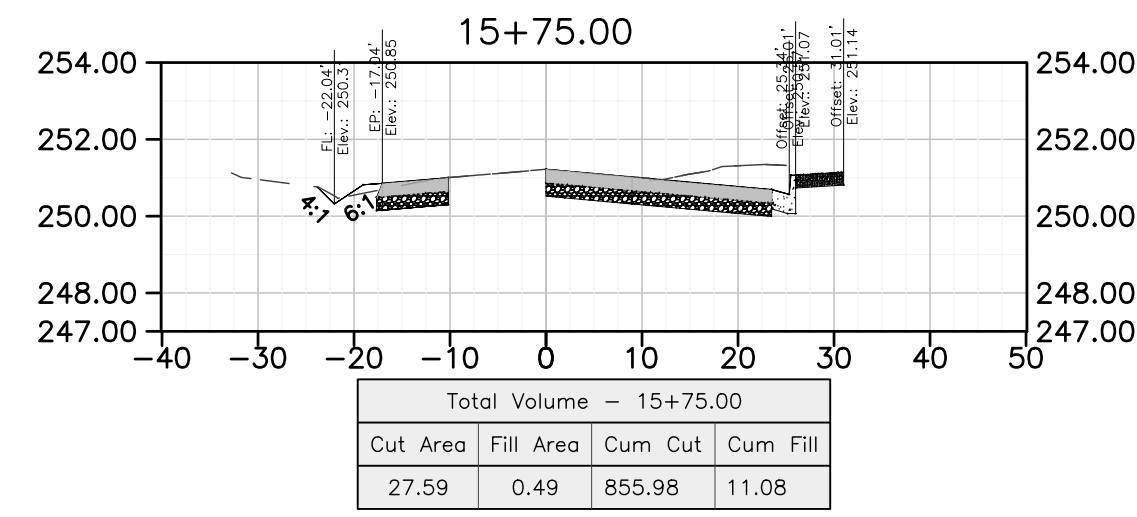
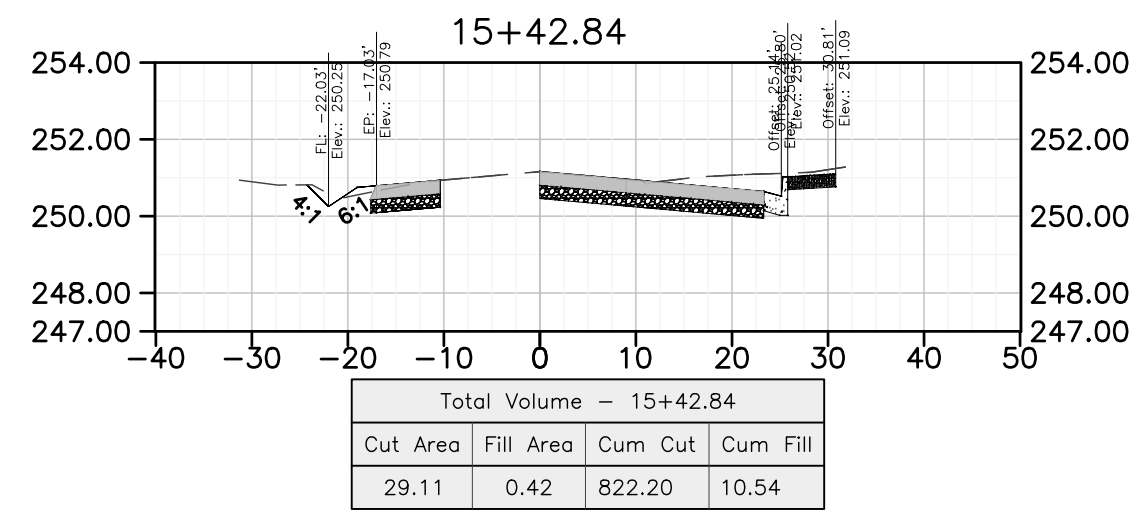
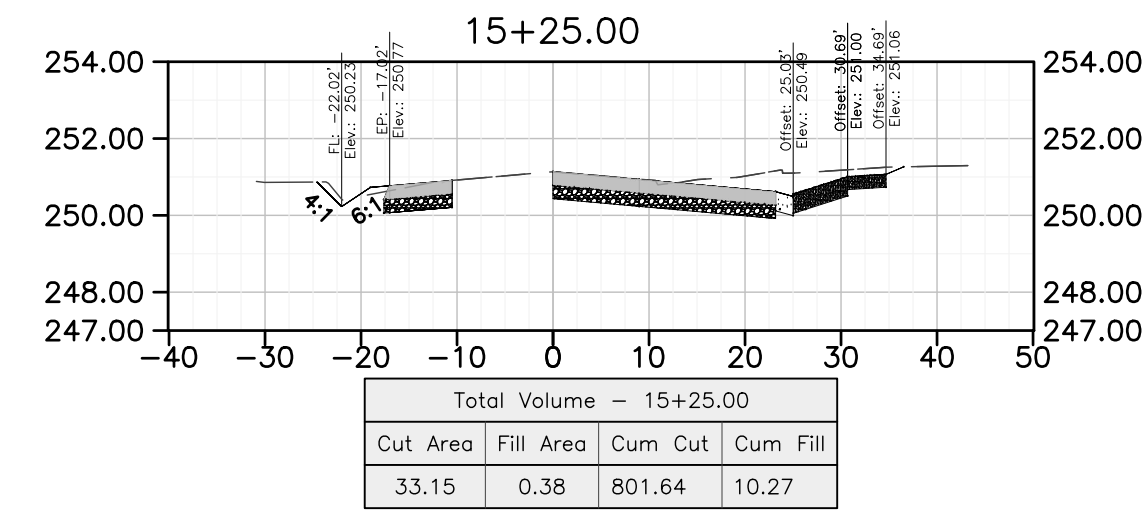
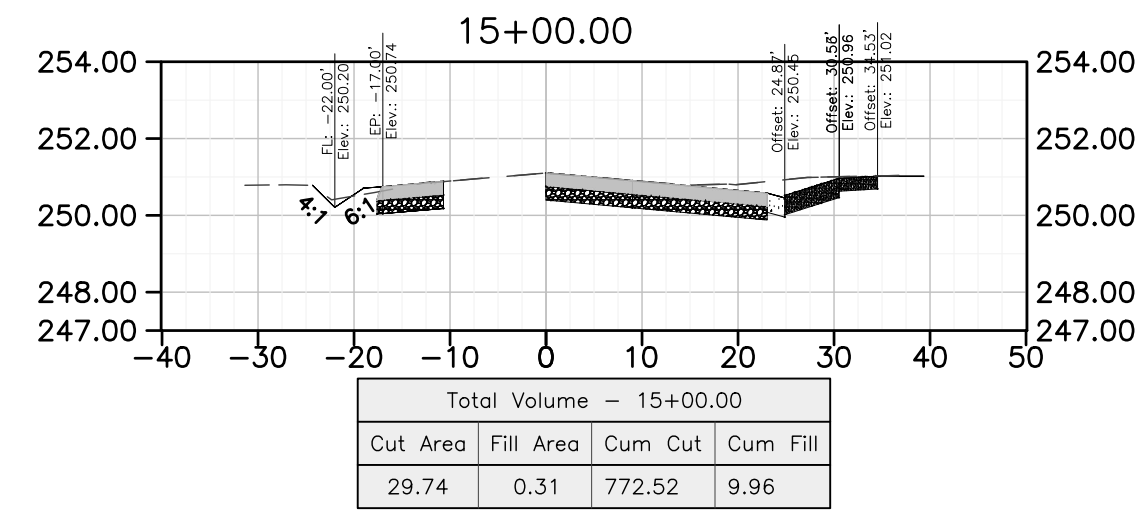
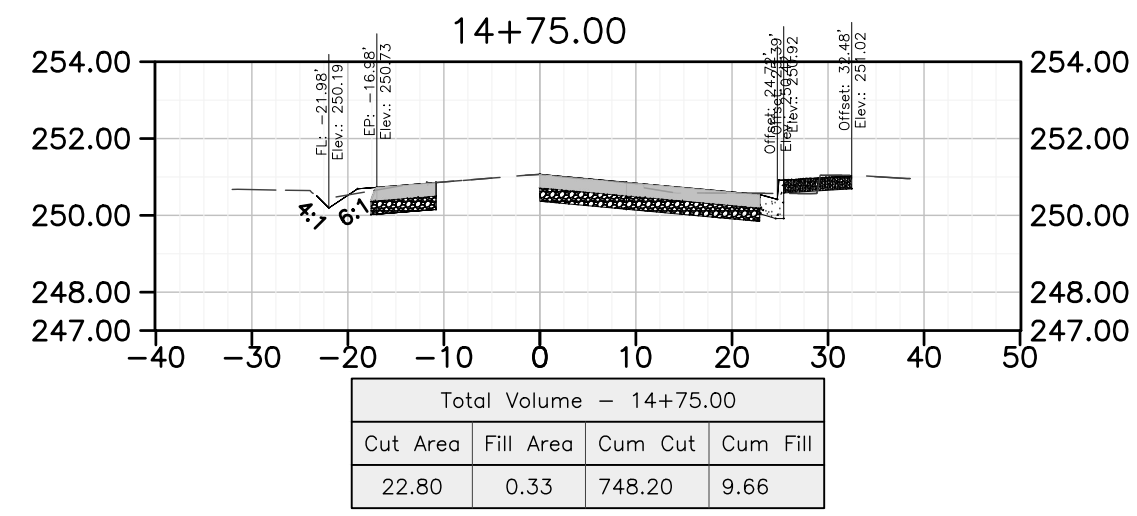

DEPARTMENT OF PUBLIC WORKS AND PLANNING

BIOLA AVE. - SECTION SHEET 3

DRAWING NO. ### SHEET NO. 3 TOTAL 8

PROJECT
ATP - BIOLA COMMUNITY SIDEWALK

ROAD NO. ### BRIDGE NO. ###

SCALE
HORIZ 0 20' 40'
VERT 0 5 10

DESIGNED: ###
DRAWN: ###
CHECKED: ###

DATE: ###

THESE CROSS SECTIONS ARE FOR THE CONTRACTOR'S INFORMATION ONLY. THEY ARE NOT TO BE CONSIDERED TO BE PART OF THE CONTRACT DOCUMENTS AND SHALL HAVE NO BEARING WHATSOEVER ON THE INTERPRETATION OF THE STANDARD SPECIFICATIONS, THE STANDARD PLANS, THE SPECIAL PROVISIONS, NOR SHALL THEY HAVE ANY BEARING WHATSOEVER ON THE INTERPRETATION OF THE OTHER PUBLICATIONS REFERENCED THEREIN.

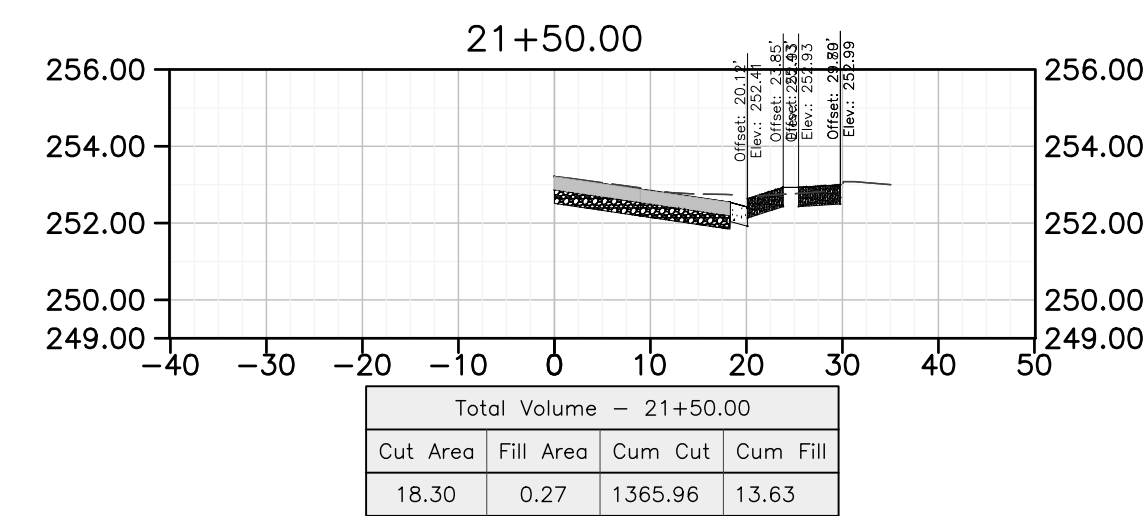
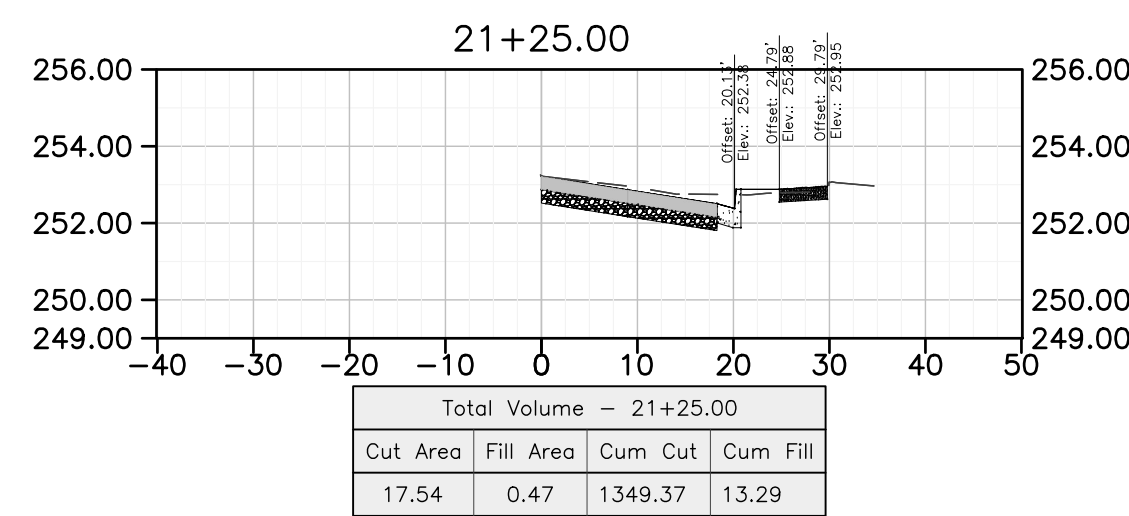
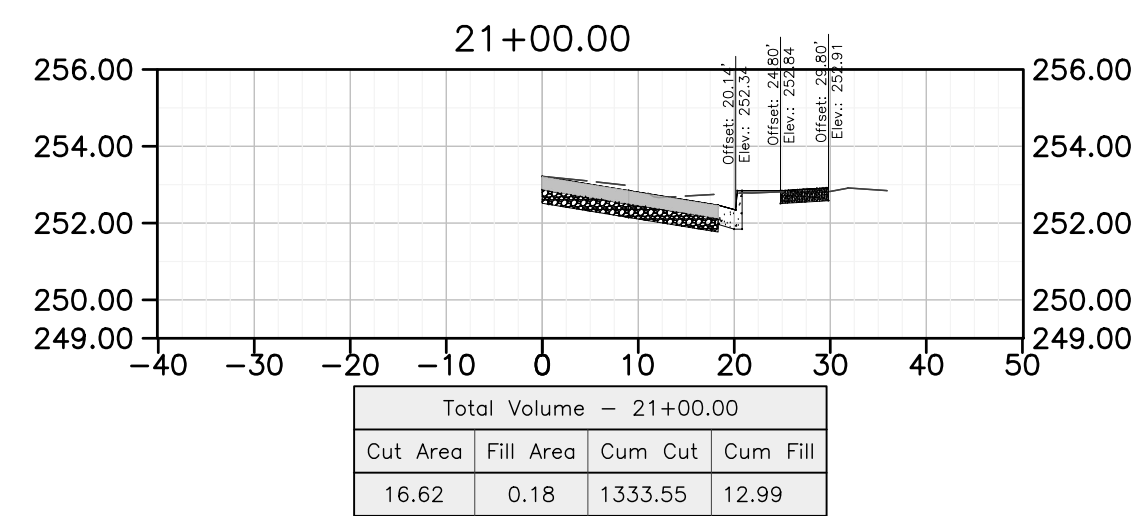
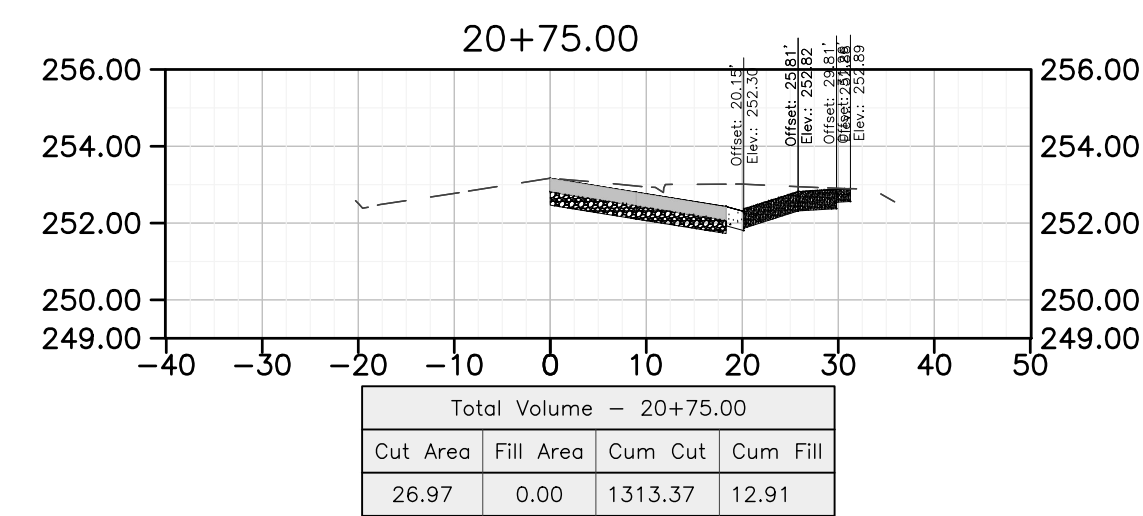
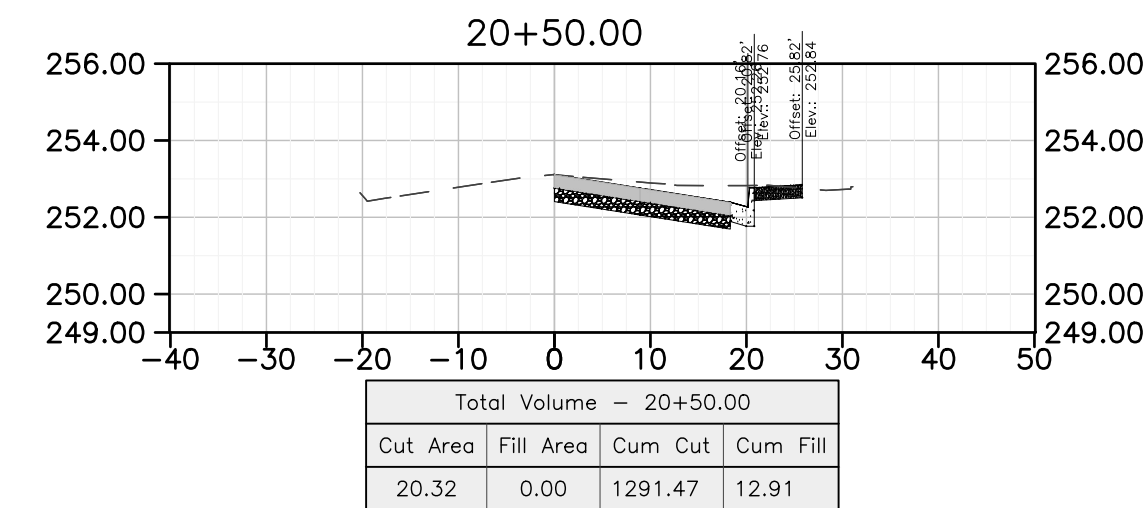
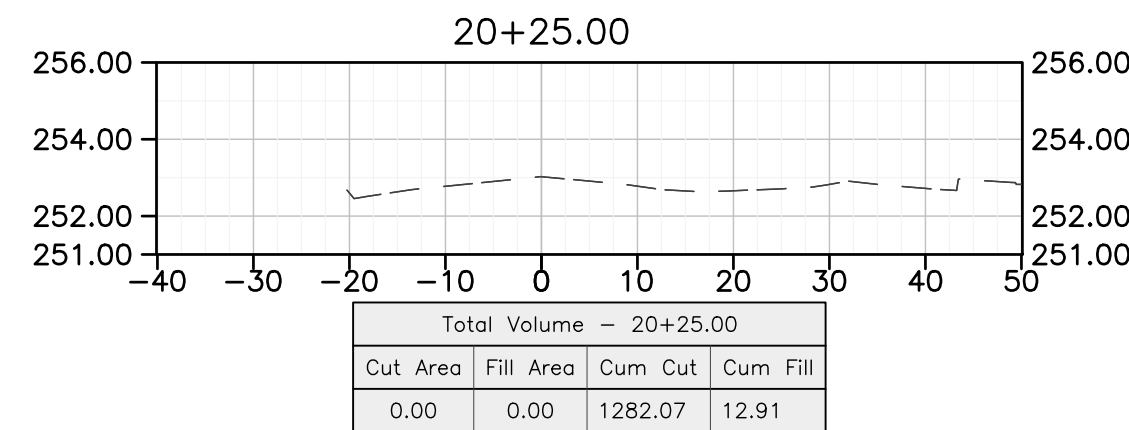
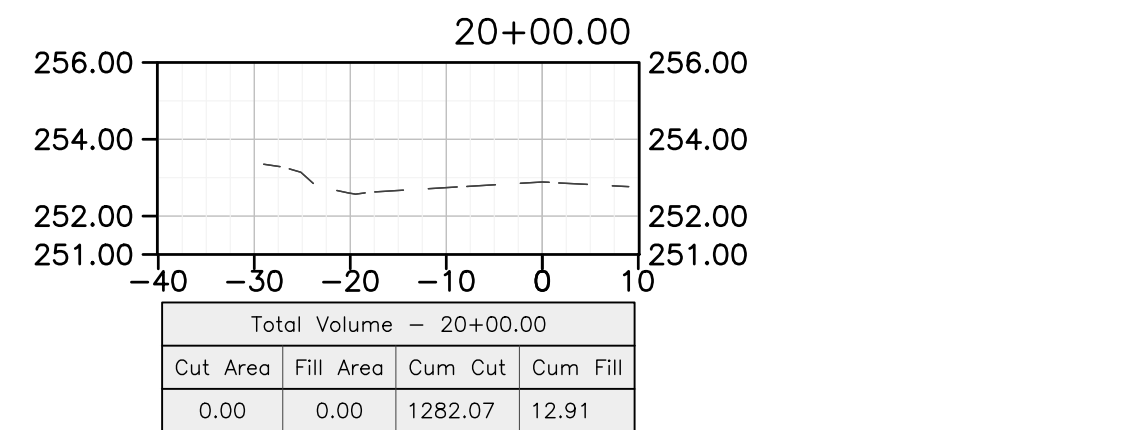
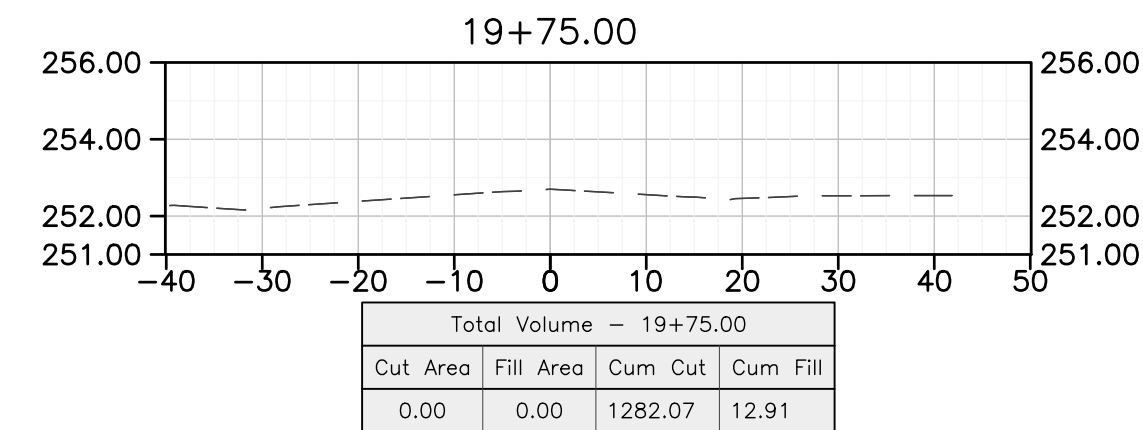
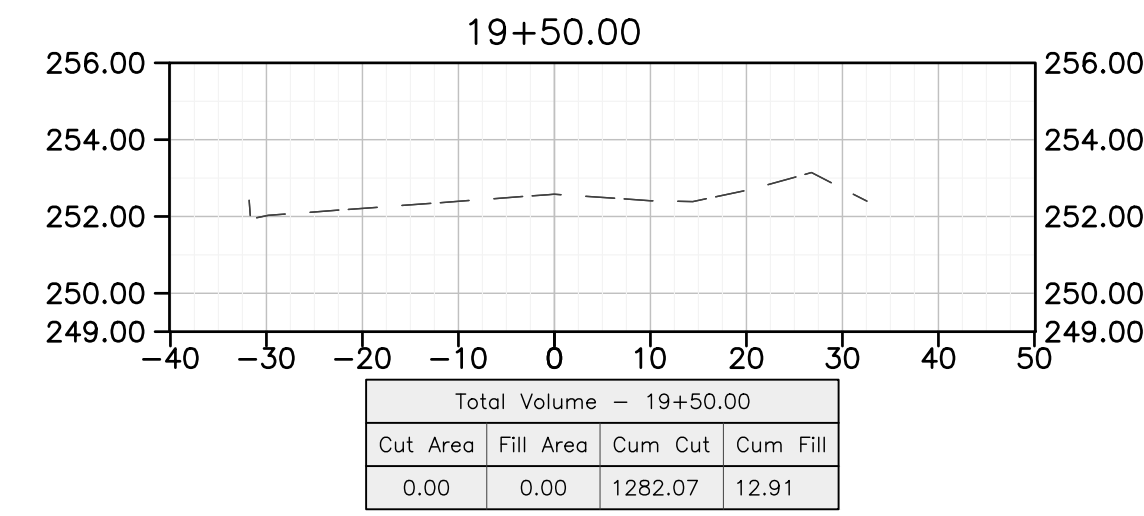
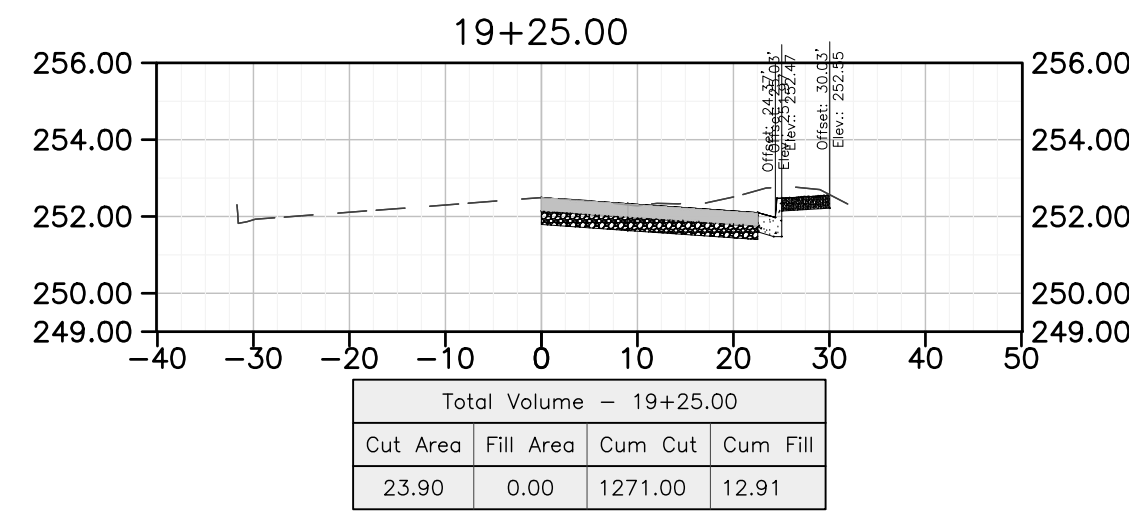
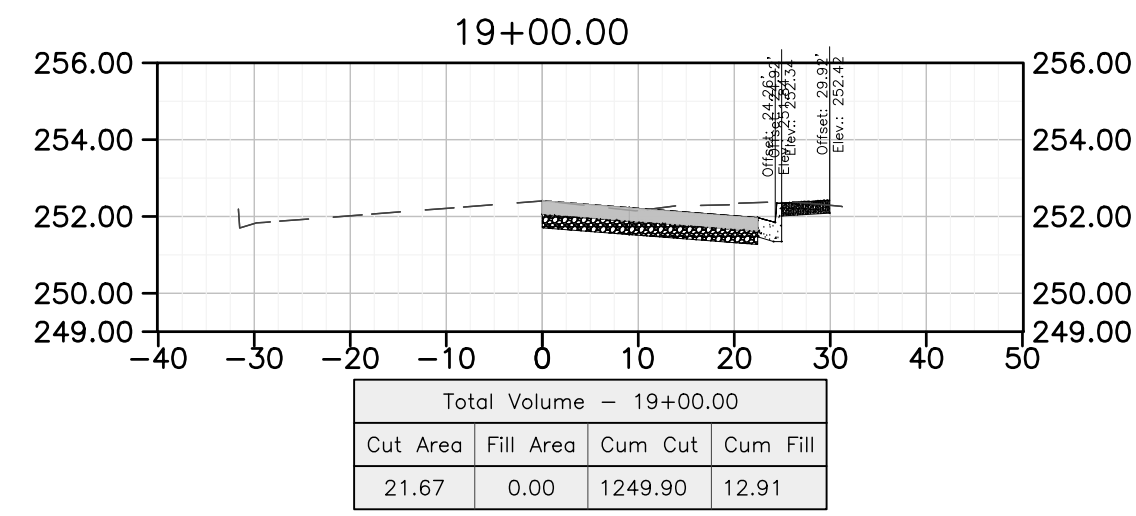
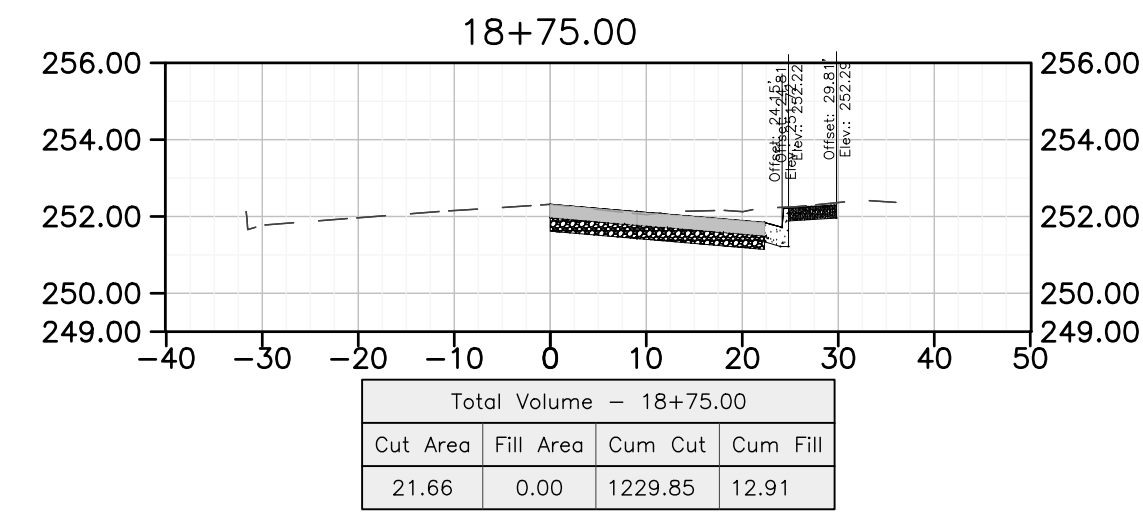
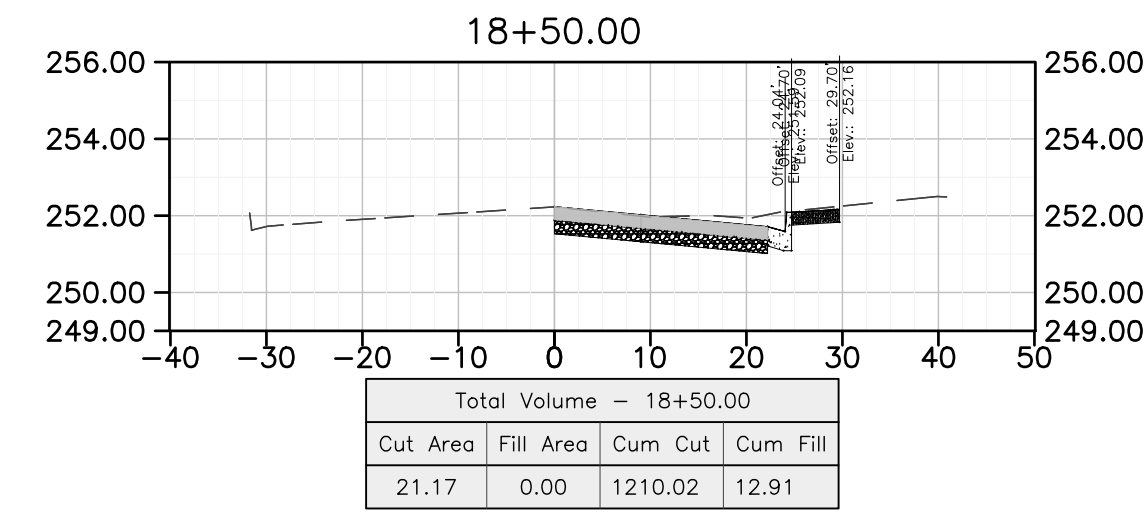
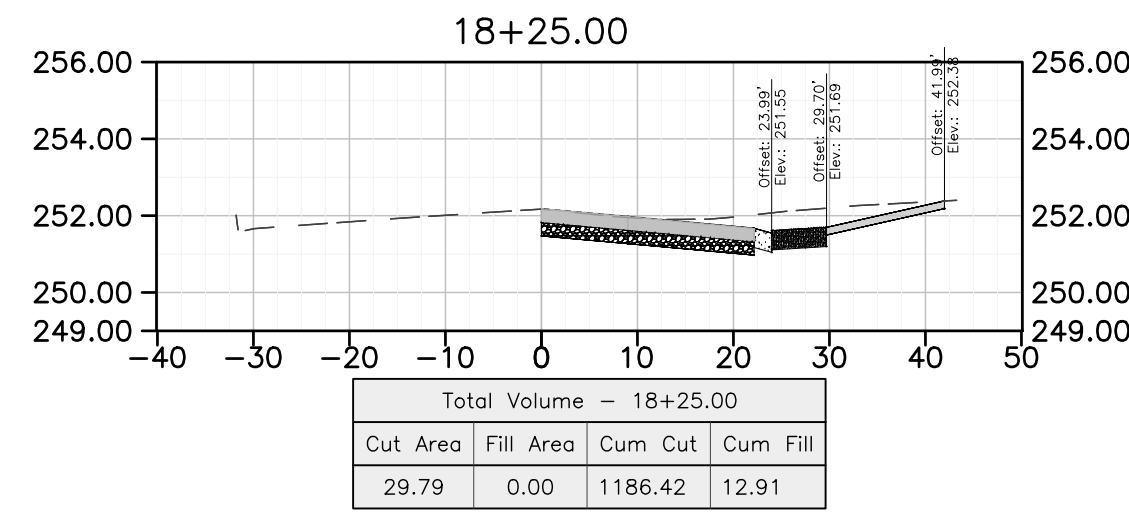
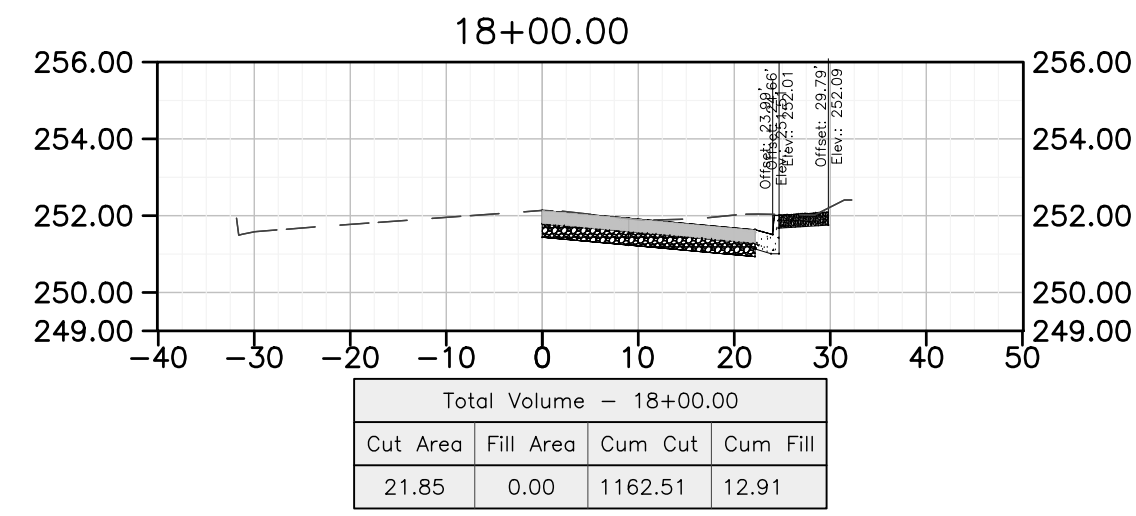
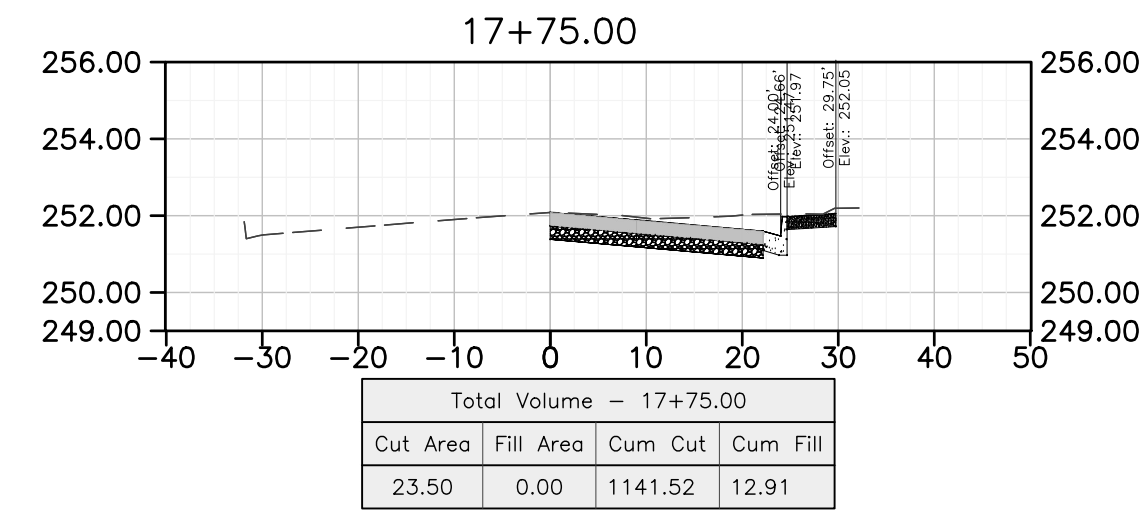

DEPARTMENT OF PUBLIC WORKS AND PLANNING

BIOLA AVE. - SECTION SHEET 4

PROJECT
ATP - BIOLA COMMUNITY SIDEWALK

SCALE
HORIZ 0 20' 40'
VERT 0 5 10

ROAD NO. ### BRIDGE NO. ###

DRAWING NO. ### SHEET NO. 4 TOTAL 8

DESIGNED: ###
DRAWN: ###
CHECKED: ###

DATE: ###/###/###

THESE CROSS SECTIONS ARE FOR THE CONTRACTOR'S INFORMATION ONLY. THEY ARE NOT TO BE CONSIDERED TO BE PART OF THE CONTRACT DOCUMENTS AND SHALL HAVE NO BEARING WHATSOEVER ON THE INTERPRETATION OF THE STANDARD SPECIFICATIONS, THE STANDARD PLANS, THE SPECIAL PROVISIONS, NOR SHALL THEY HAVE ANY BEARING WHATSOEVER ON THE INTERPRETATION OF THE OTHER PUBLICATIONS REFERENCED THEREIN.

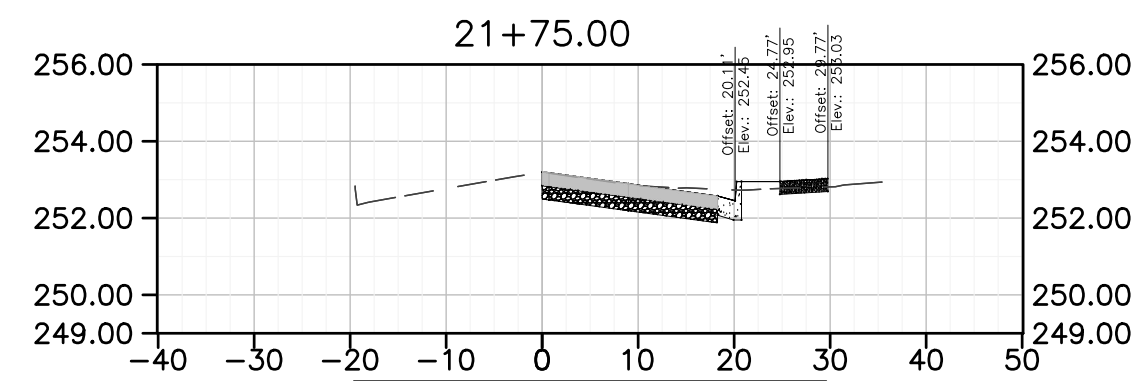

Total Volume - 21+75.00			
Cut Area	Fill Area	Cum Cut	Cum Fill
15.88	0.80	1381.78	14.13

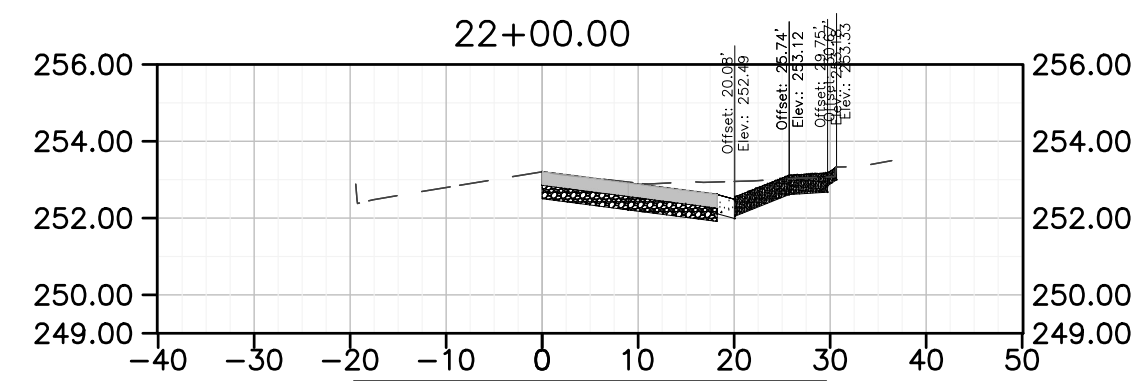

Total Volume - 22+00.00			
Cut Area	Fill Area	Cum Cut	Cum Fill
21.41	0.00	1399.05	14.50

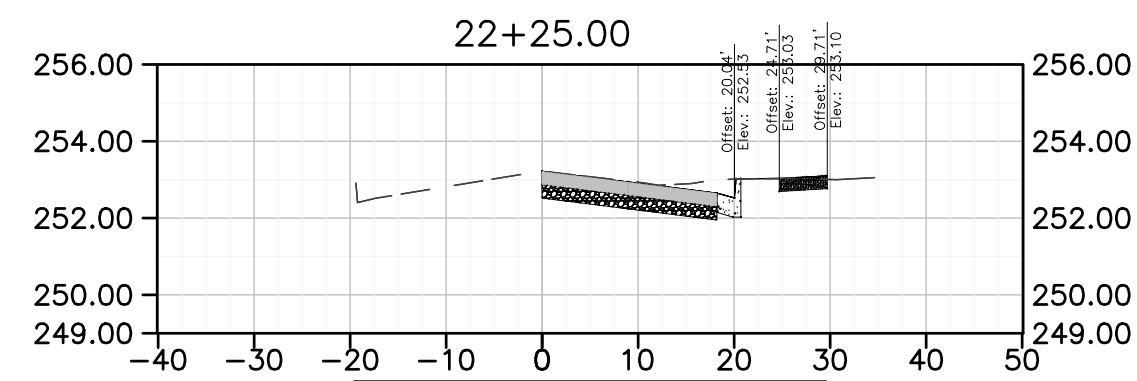

Total Volume - 22+25.00			
Cut Area	Fill Area	Cum Cut	Cum Fill
17.76	0.01	1417.18	14.51

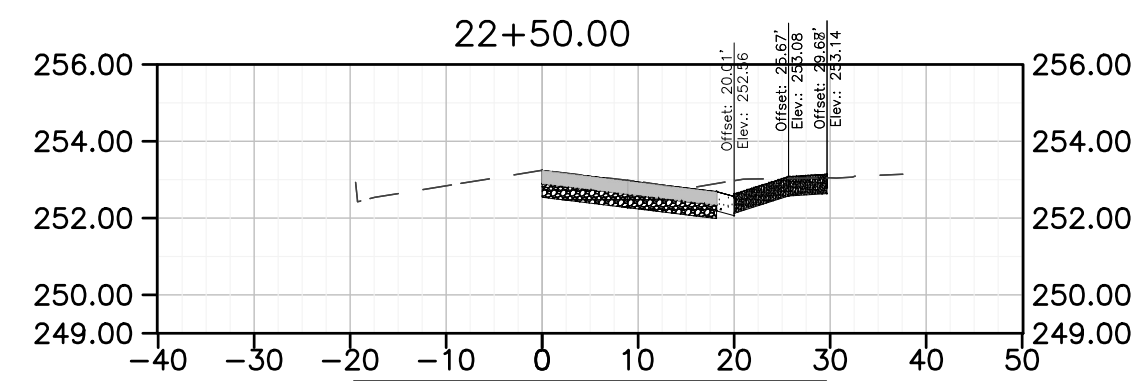

Total Volume - 22+50.00			
Cut Area	Fill Area	Cum Cut	Cum Fill
20.11	0.00	1434.71	14.51

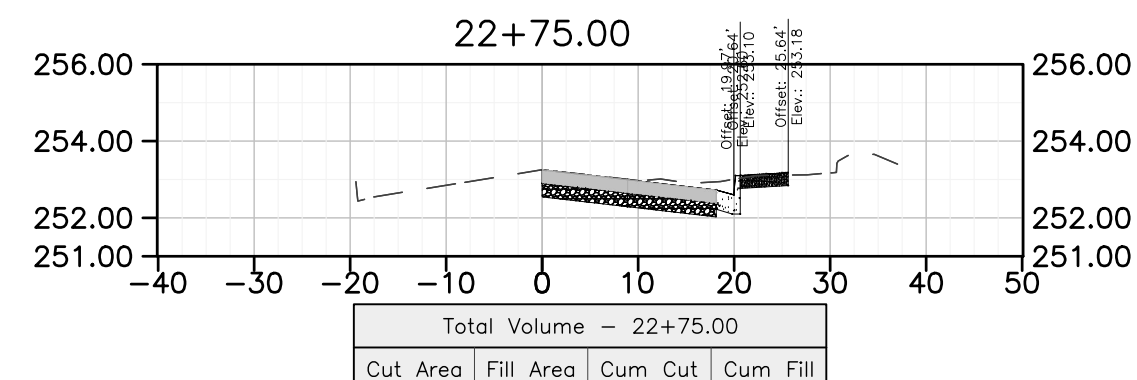

Total Volume - 22+75.00			
Cut Area	Fill Area	Cum Cut	Cum Fill
17.25	0.00	1452.01	14.51

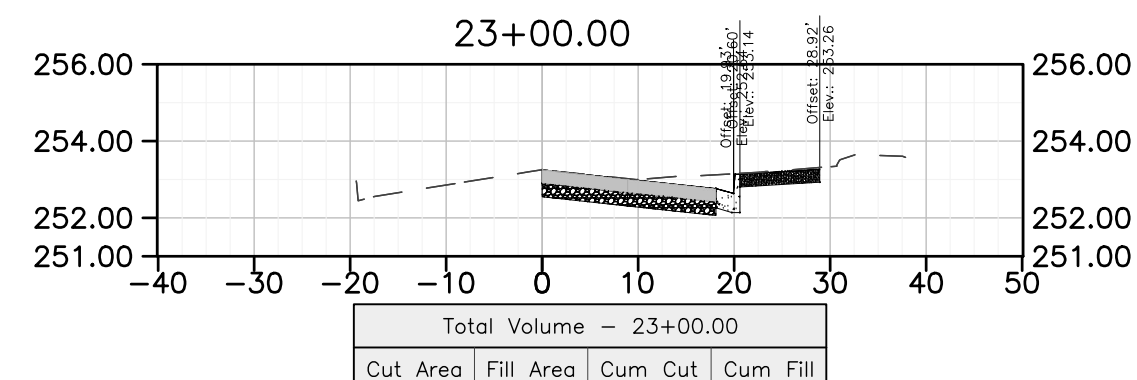

Total Volume - 23+00.00			
Cut Area	Fill Area	Cum Cut	Cum Fill
19.77	0.00	1469.16	14.51

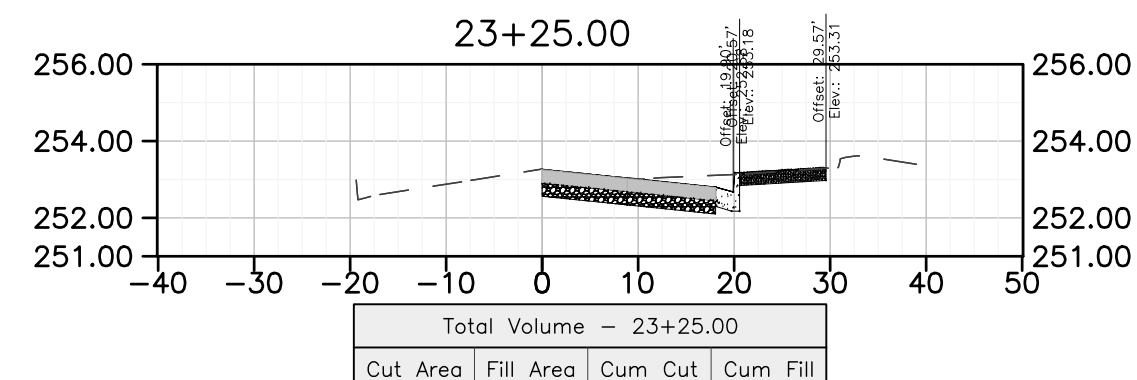

Total Volume - 23+25.00			
Cut Area	Fill Area	Cum Cut	Cum Fill
18.96	0.00	1487.09	14.51

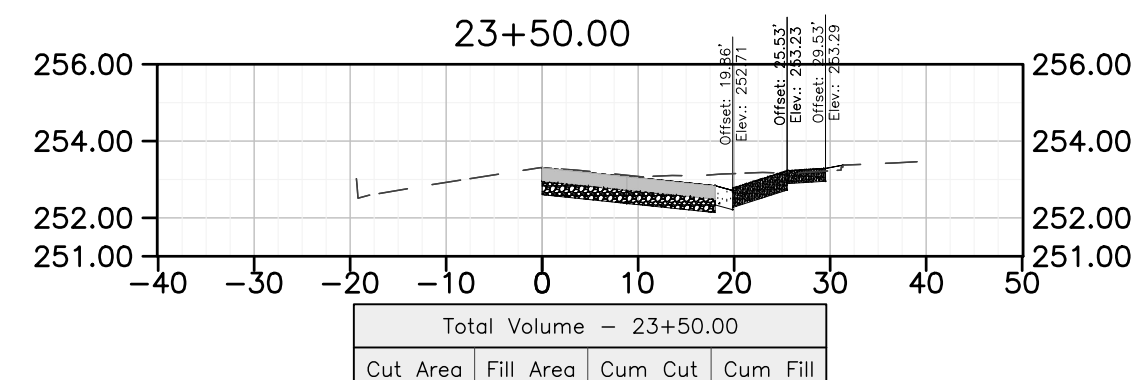

Total Volume - 23+50.00			
Cut Area	Fill Area	Cum Cut	Cum Fill
20.58	0.16	1505.39	14.58

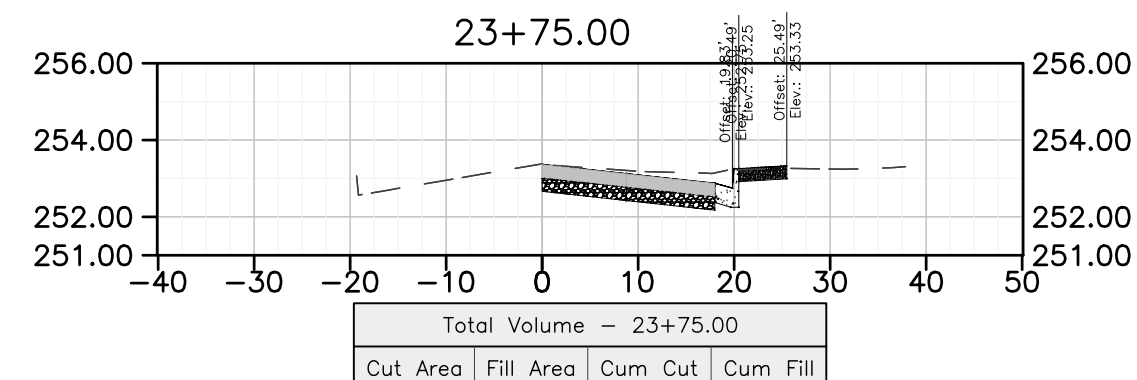

Total Volume - 23+75.00			
Cut Area	Fill Area	Cum Cut	Cum Fill
18.18	0.00	1523.33	14.66

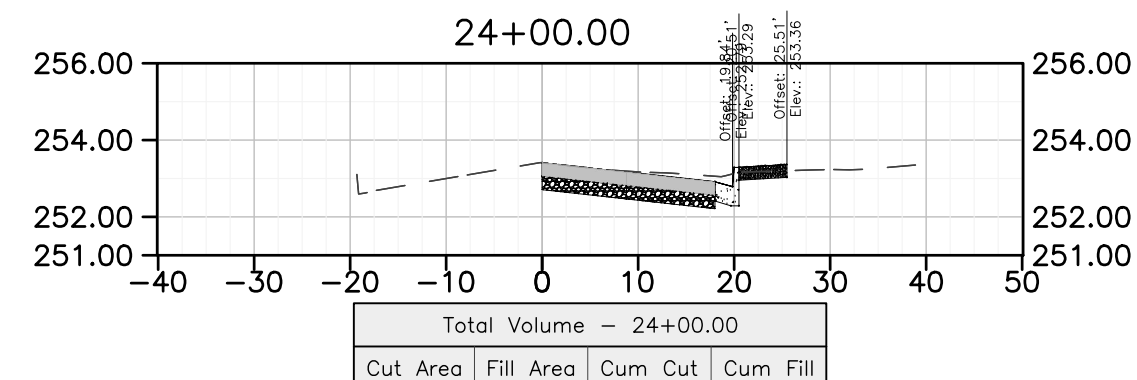

Total Volume - 24+00.00			
Cut Area	Fill Area	Cum Cut	Cum Fill
16.34	0.00	1539.31	14.66

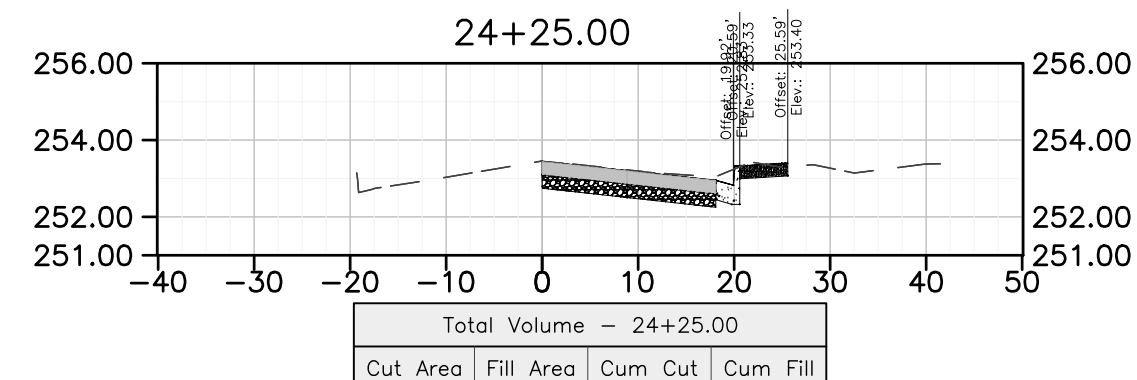

Total Volume - 24+25.00			
Cut Area	Fill Area	Cum Cut	Cum Fill
16.88	0.00	1554.69	14.66

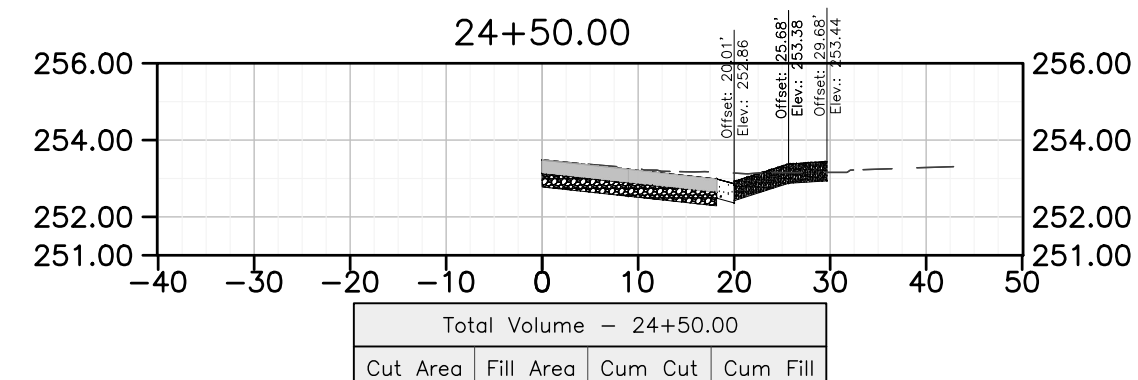

Total Volume - 24+50.00			
Cut Area	Fill Area	Cum Cut	Cum Fill
18.83	0.00	1571.22	14.66

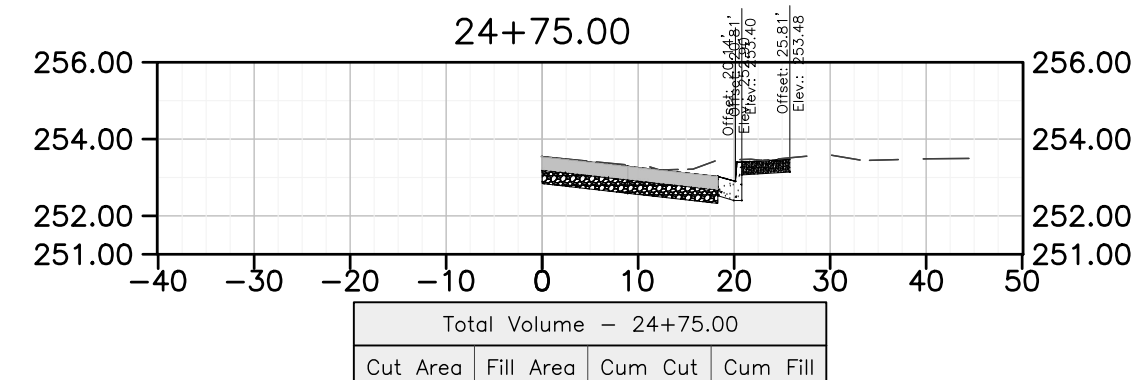

Total Volume - 24+75.00			
Cut Area	Fill Area	Cum Cut	Cum Fill
18.40	0.00	1588.46	14.66

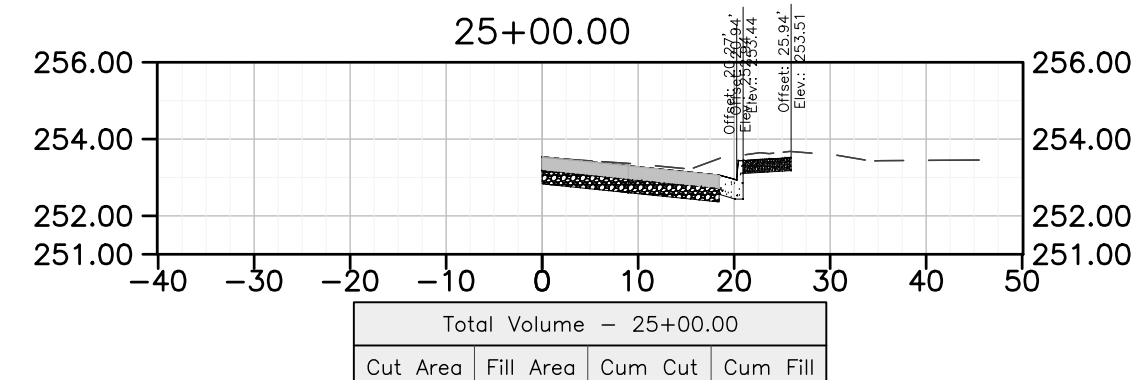

Total Volume - 25+00.00			
Cut Area	Fill Area	Cum Cut	Cum Fill
19.48	0.00	1606.00	14.66

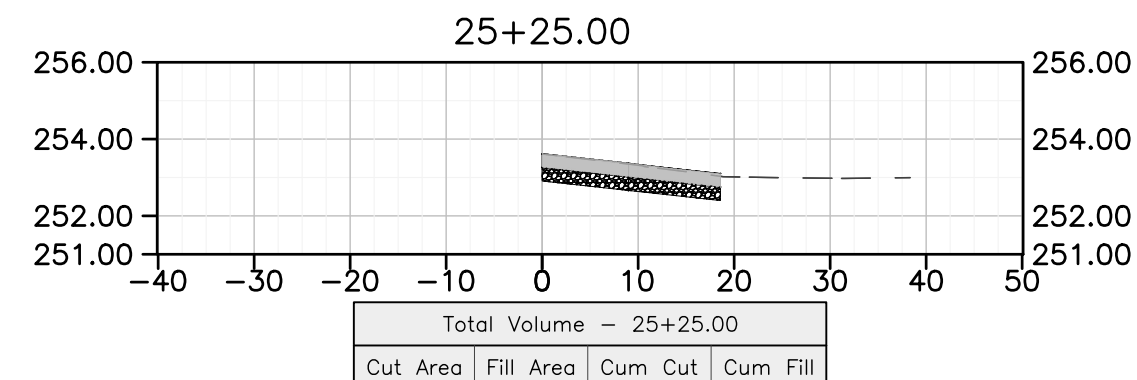

Total Volume - 25+25.00			
Cut Area	Fill Area	Cum Cut	Cum Fill
12.56	0.00	1620.83	14.66

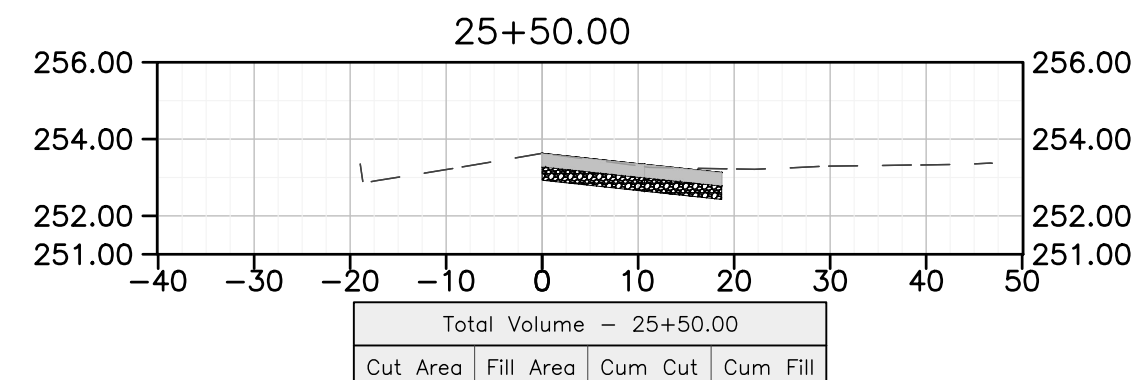

Total Volume - 25+50.00			
Cut Area	Fill Area	Cum Cut	Cum Fill
12.87	0.00	1632.61	14.66

DEPARTMENT OF PUBLIC WORKS AND PLANNING

BIOLA AVE. - SECTION SHEET 5

DRAWING NO. ### SHEET NO. 5 TOTAL 8



PROJECT
ATP - BIOLA COMMUNITY SIDEWALK

ROAD NO. ### BRIDGE NO. ###

SCALE

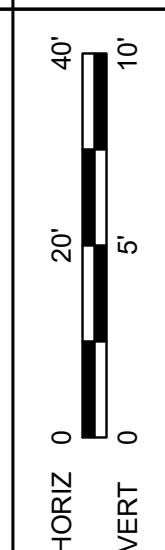

DATE

DESIGNED: ###
DRAWN: ###
CHECKED: ###

THESE CROSS SECTIONS ARE FOR THE CONTRACTOR'S INFORMATION ONLY. THEY ARE NOT TO BE CONSIDERED TO BE PART OF THE CONTRACT DOCUMENTS AND SHALL HAVE NO BEARING WHATSOEVER ON THE INTERPRETATION OF THE STANDARD SPECIFICATIONS, THE STANDARD PLANS, THE SPECIAL PROVISIONS, NOR SHALL THEY HAVE ANY BEARING WHATSOEVER ON THE INTERPRETATION OF THE OTHER PUBLICATIONS REFERENCED THEREIN.

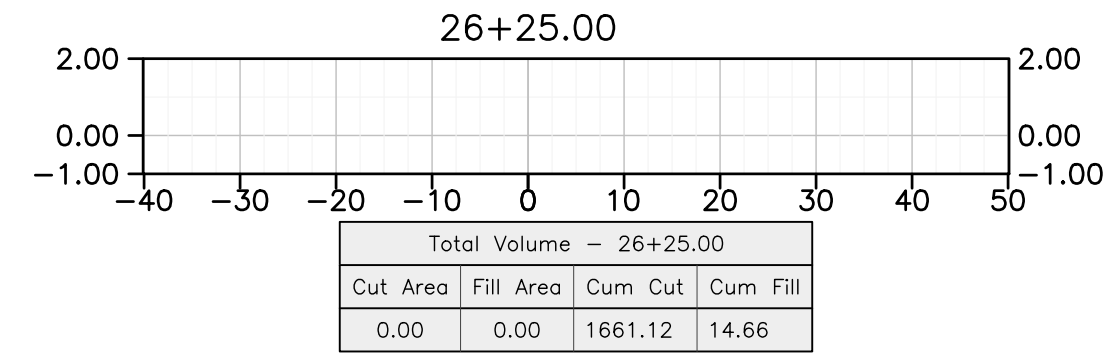
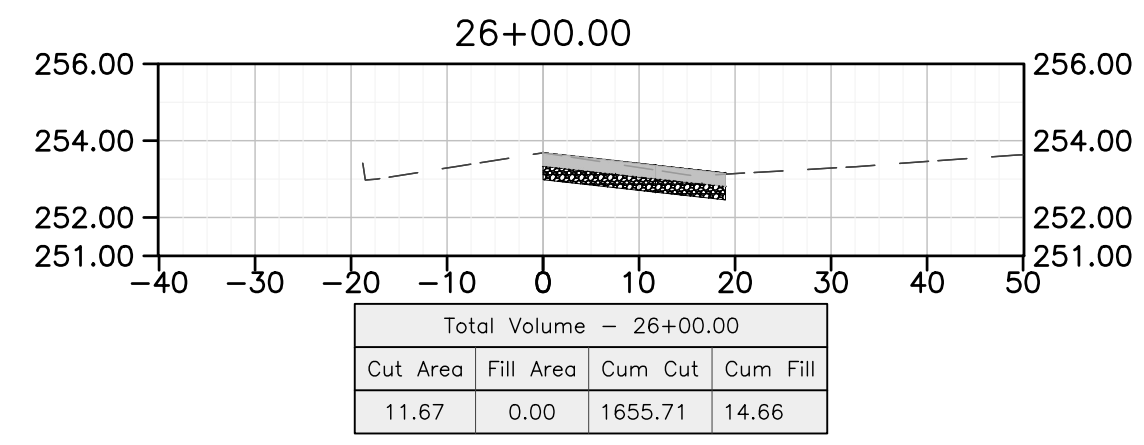
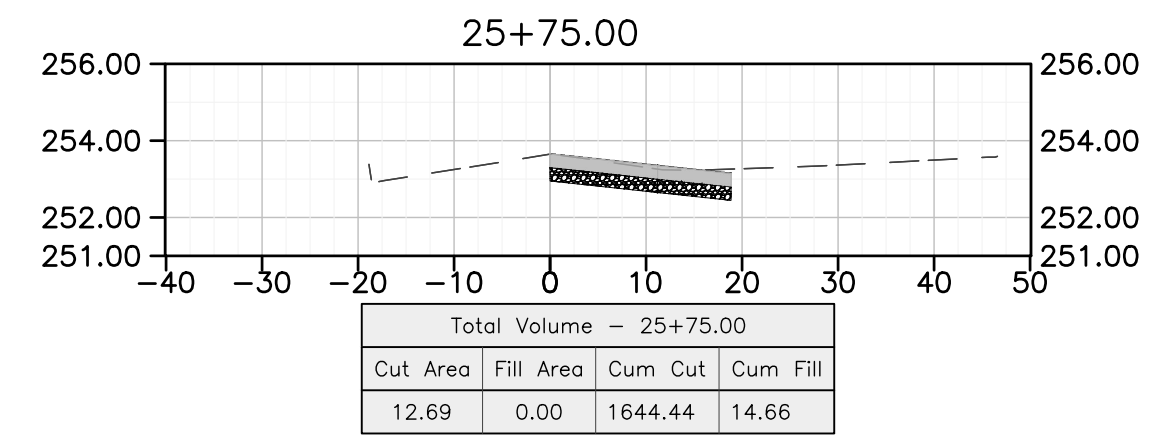

	PROJECT	SCALE	DATE	DEPARTMENT OF PUBLIC WORKS AND PLANNING
DESIGNED: ###	ATP - BIOLA COMMUNITY SIDEWALK	HORIZ 0 20' 40' VERT 0 5 10	###	BIOLA AVE. - SECTION SHEET 6
DRAWN: ###	###	###	DRAWING NO. ###	
CHECKED: ###	###	###	SHEET NO. 6	
				TOTAL 8



THESE CROSS SECTIONS ARE FOR THE CONTRACTOR'S INFORMATION ONLY. THEY ARE NOT TO BE CONSIDERED TO BE PART OF THE CONTRACT DOCUMENTS AND SHALL HAVE NO BEARING WHATSOEVER ON THE INTERPRETATION OF THE STANDARD SPECIFICATIONS, THE STANDARD PLANS, THE SPECIAL PROVISIONS, NOR SHALL THEY HAVE ANY BEARING WHATSOEVER ON THE INTERPRETATION OF THE OTHER PUBLICATIONS REFERENCED THEREIN.

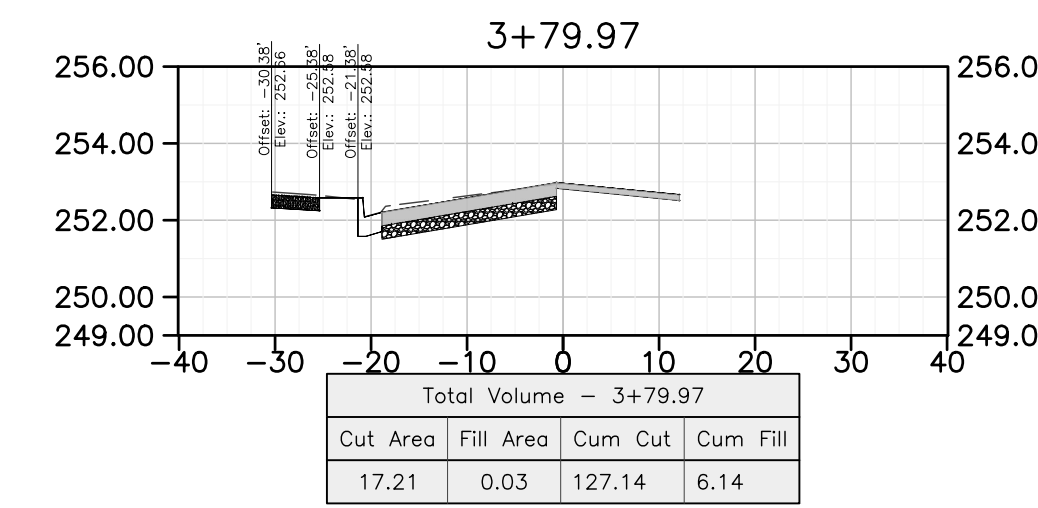
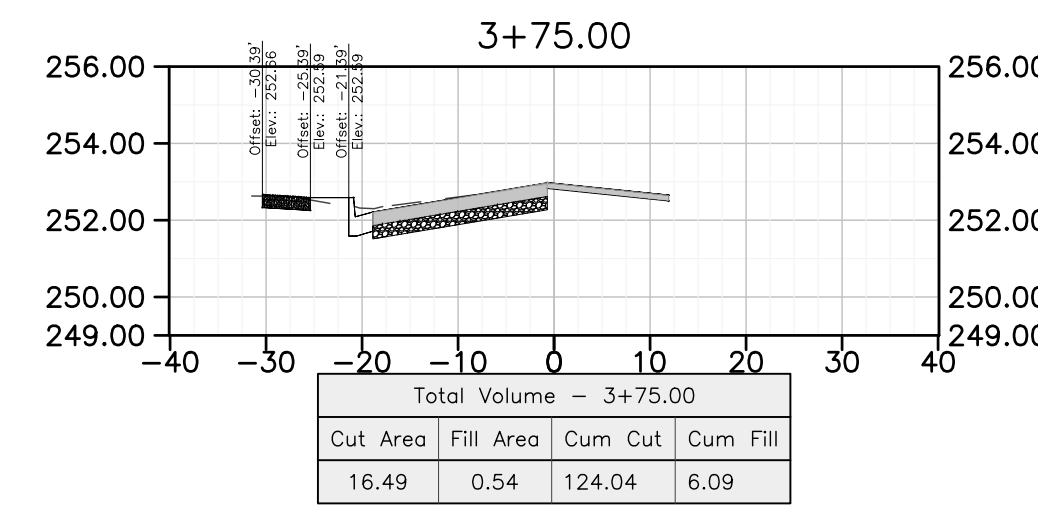
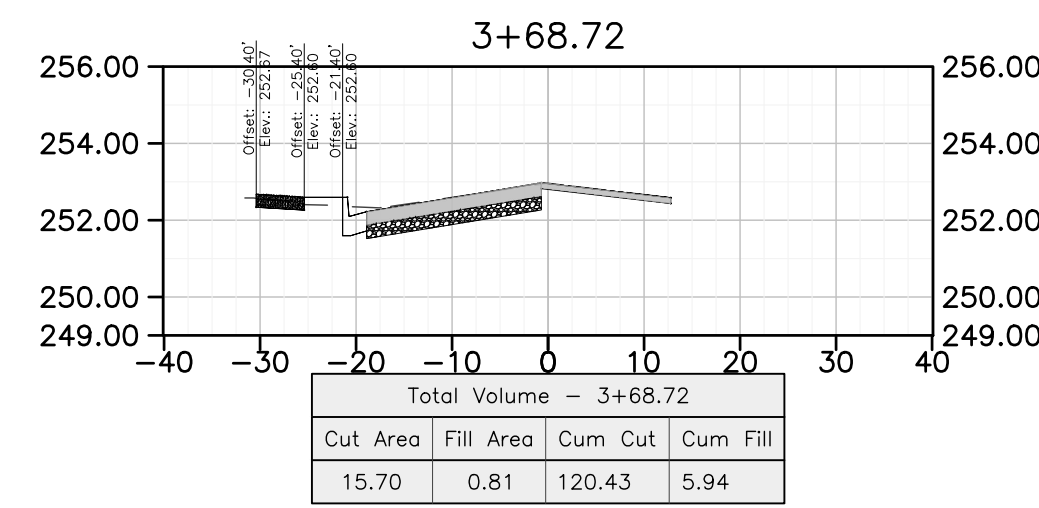
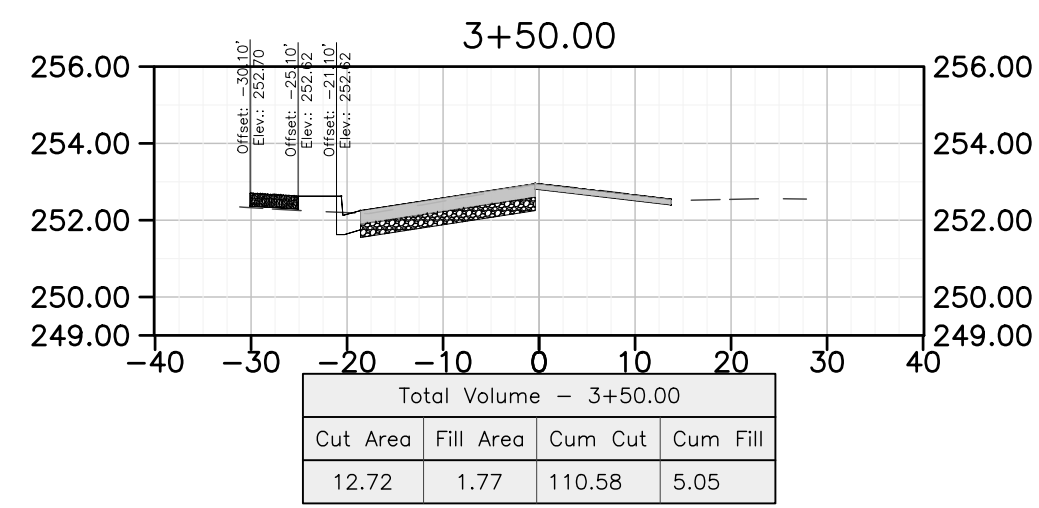
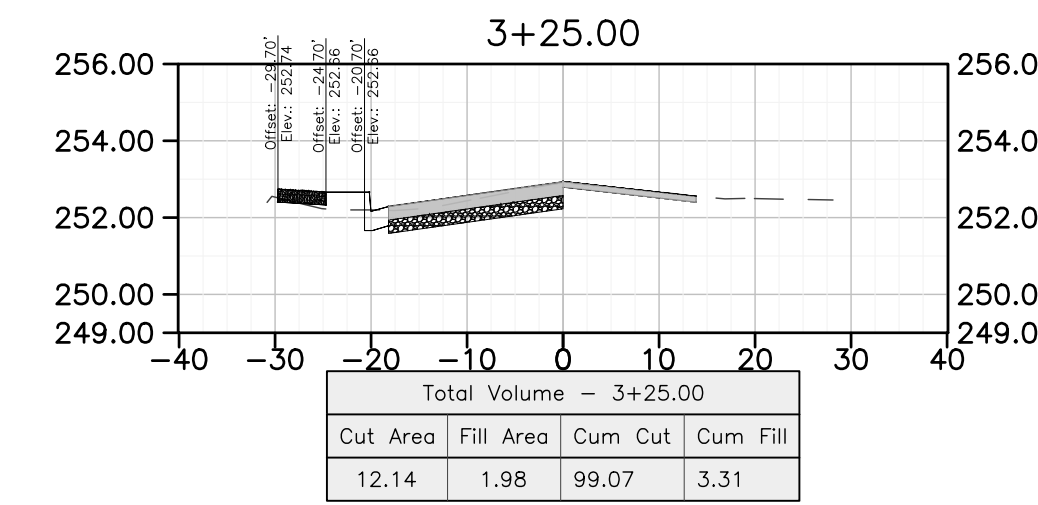
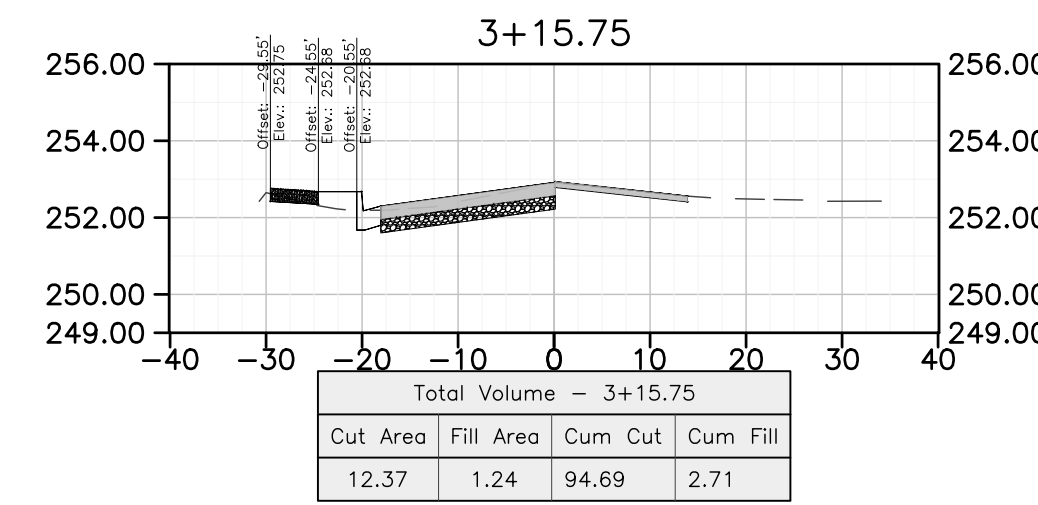
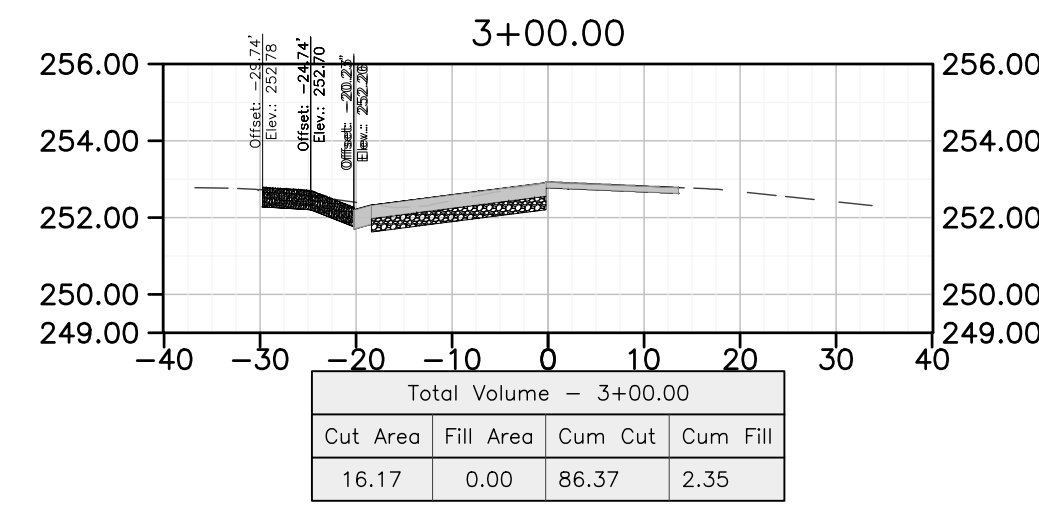
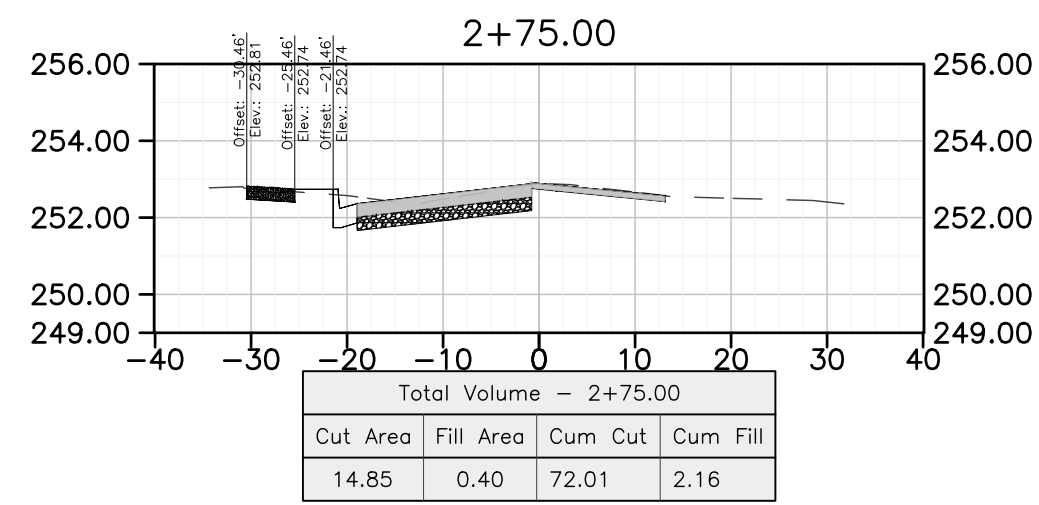
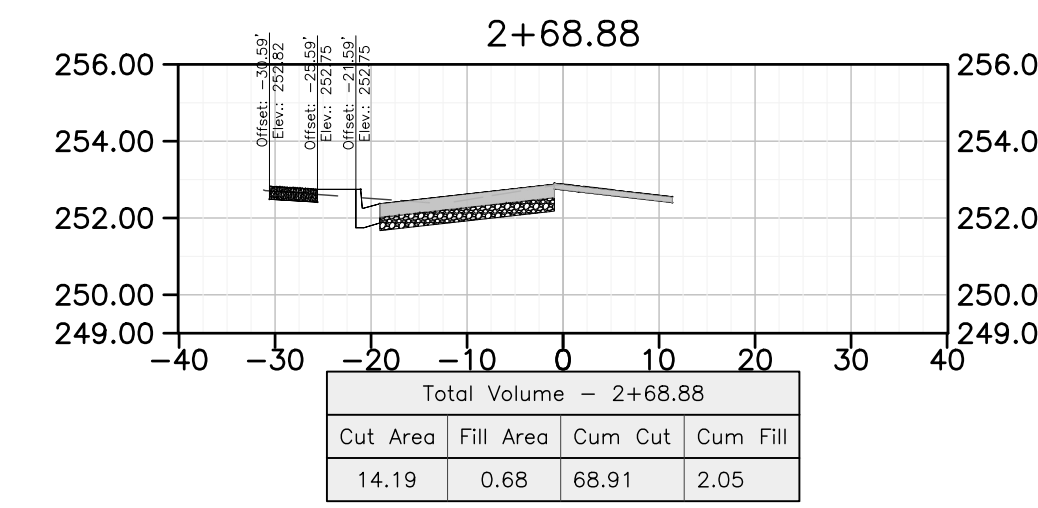
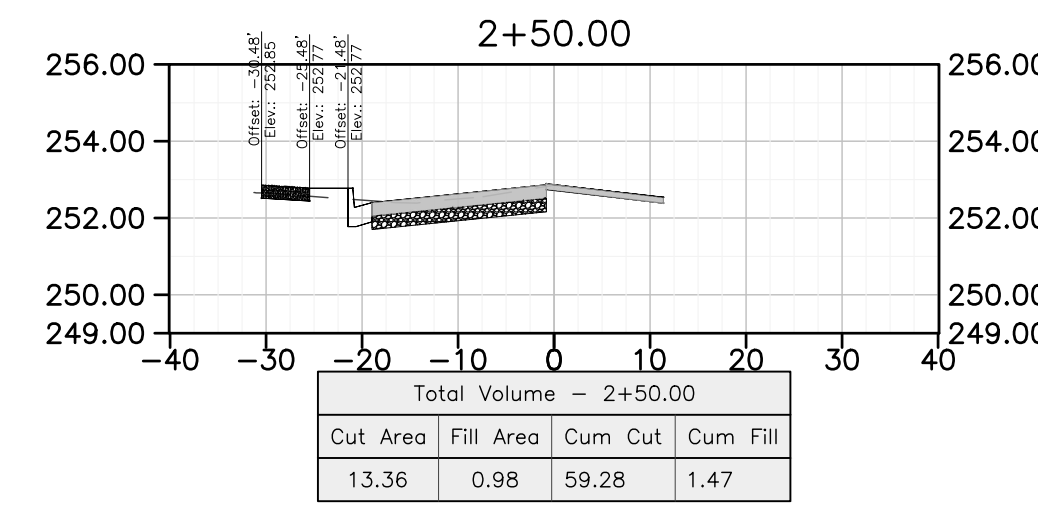
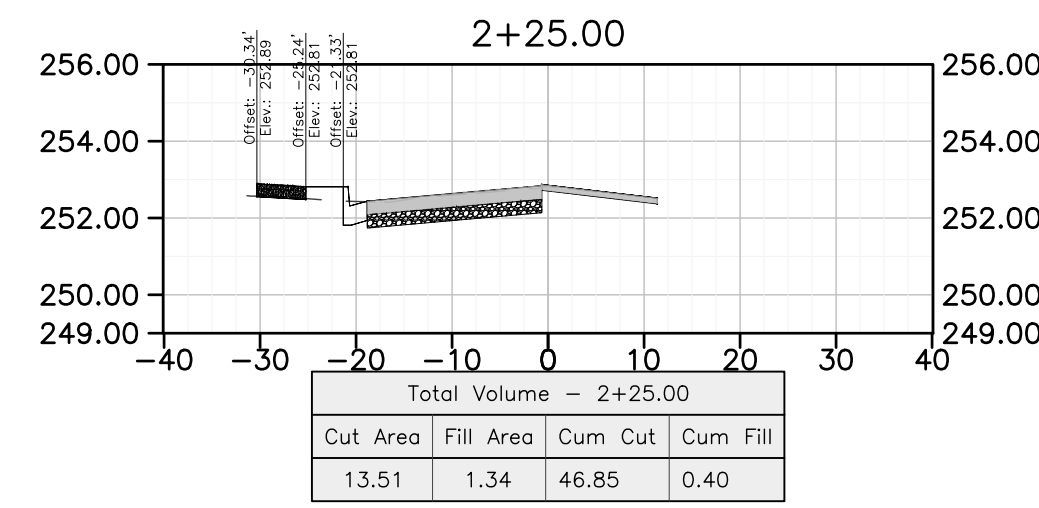
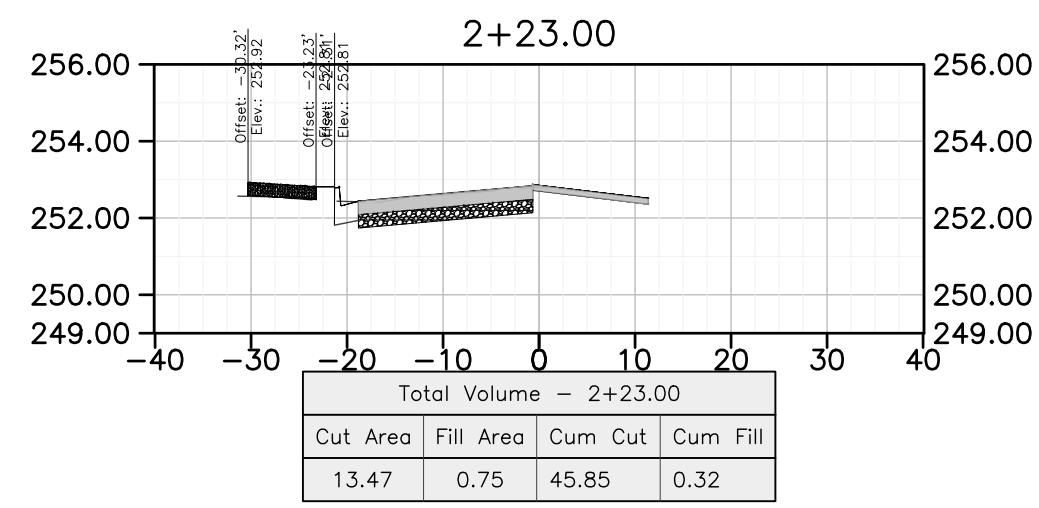
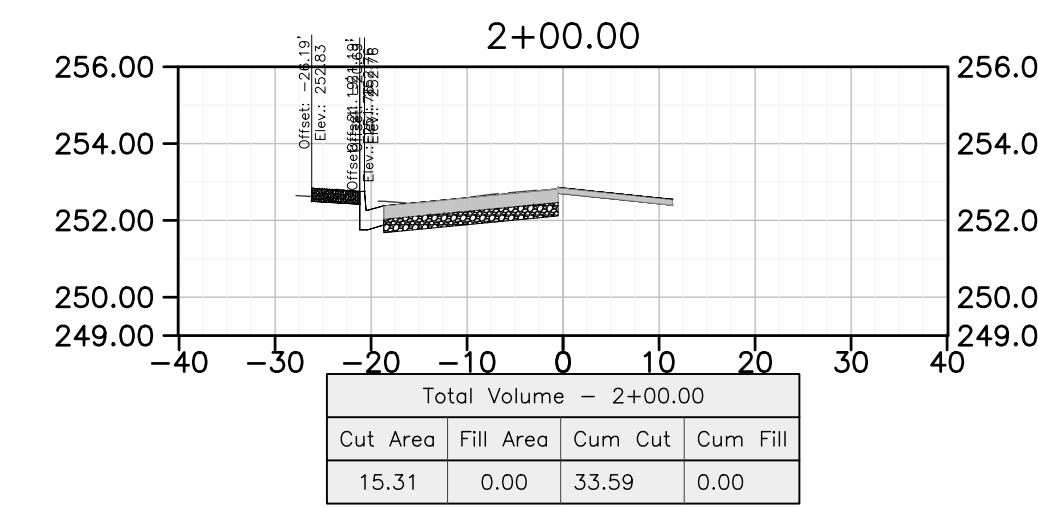
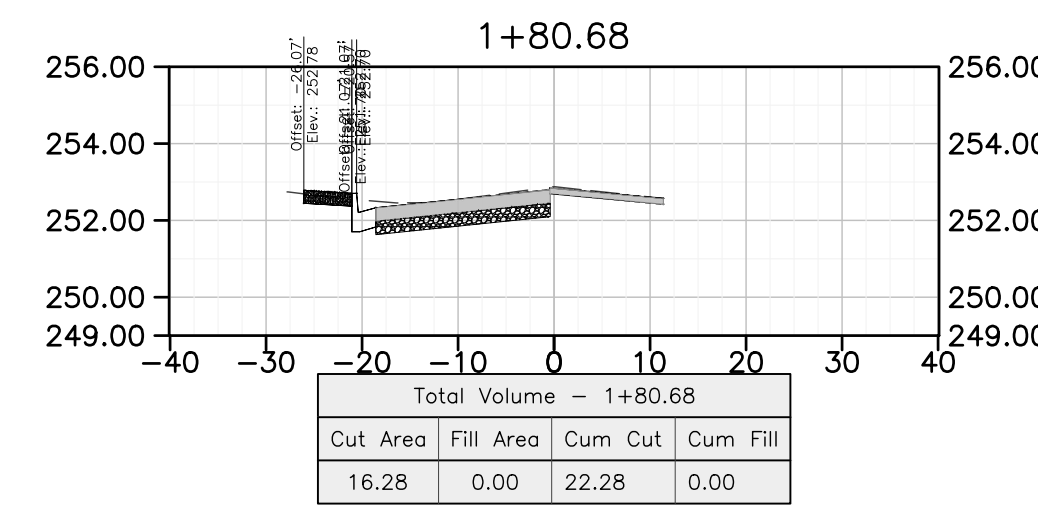
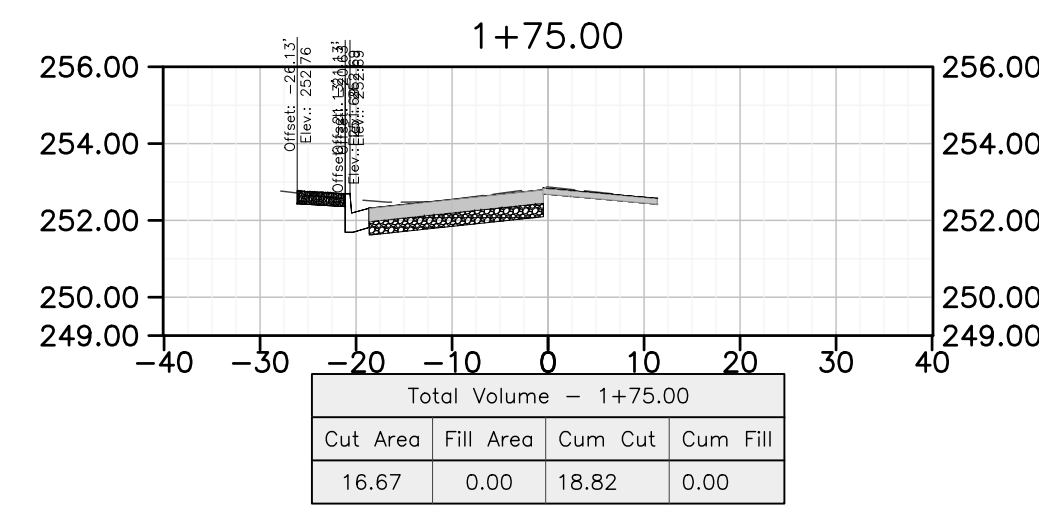
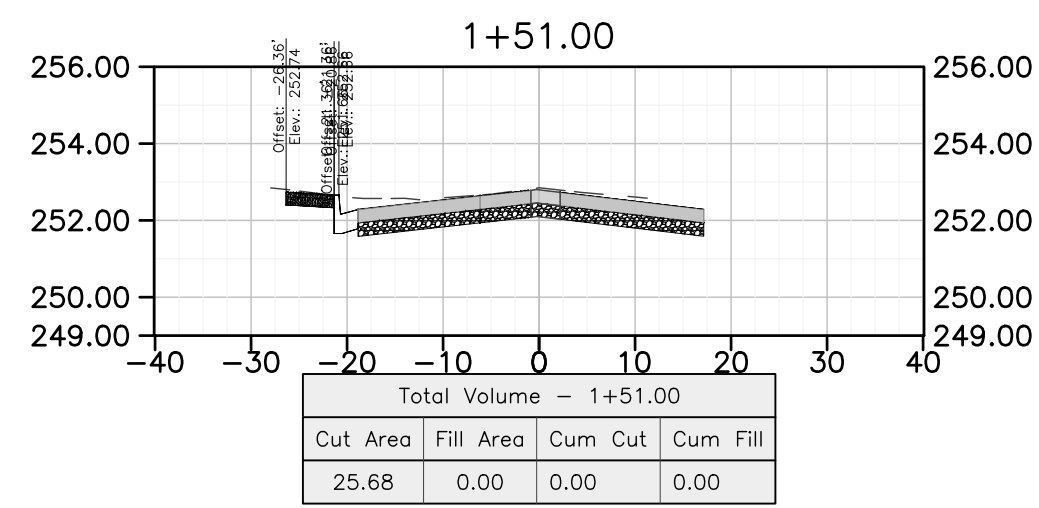

DEPARTMENT OF PUBLIC WORKS AND PLANNING

C ST. - SECTION SHEET 7

DRAWING NO. ### SHEET NO. 7 TOTAL 8

PROJECT
ATP - BIOLA COMMUNITY SIDEWALK
ROAD NO. ### BRIDGE NO. ###

SCALE
HORIZ 0 20' 40'
VERT 0 5 10

DESIGNED: ###
DRAWN: ###
CHECKED: ###

DATE: ###

THESE CROSS SECTIONS ARE FOR THE CONTRACTOR'S INFORMATION ONLY. THEY ARE NOT TO BE CONSIDERED TO BE PART OF THE CONTRACT DOCUMENTS AND SHALL HAVE NO BEARING WHATSOEVER ON THE INTERPRETATION OF THE STANDARD SPECIFICATIONS, THE STANDARD PLANS, THE SPECIAL PROVISIONS, NOR SHALL THEY HAVE ANY BEARING WHATSOEVER ON THE INTERPRETATION OF THE OTHER PUBLICATIONS REFERENCED THEREIN.

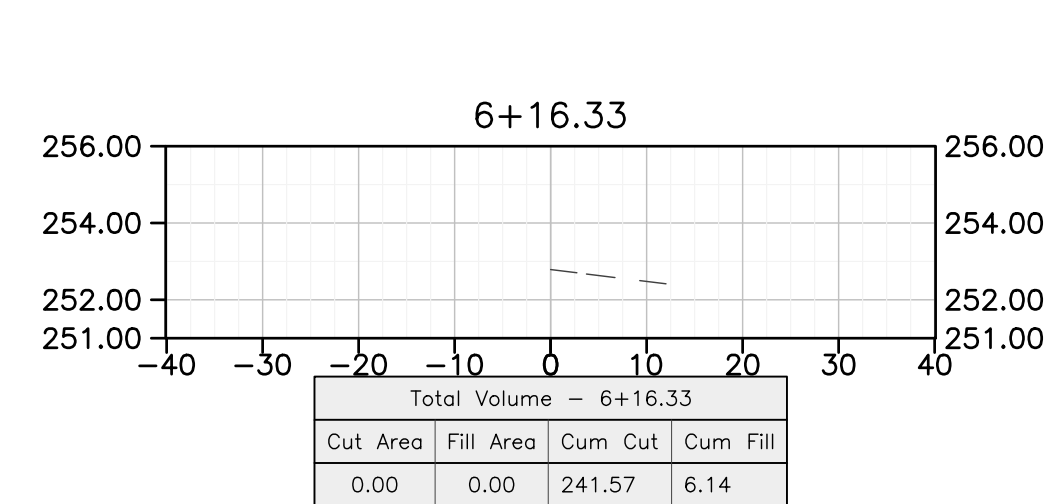
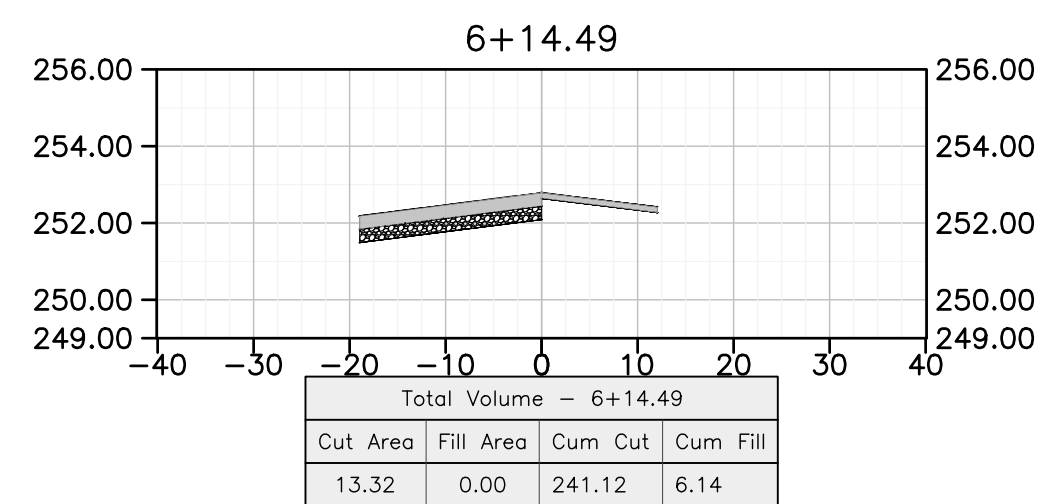
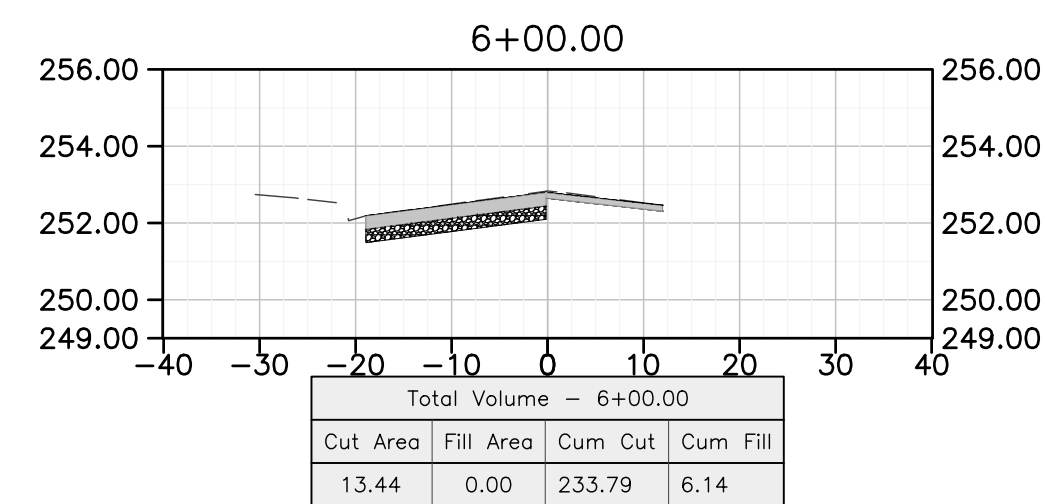
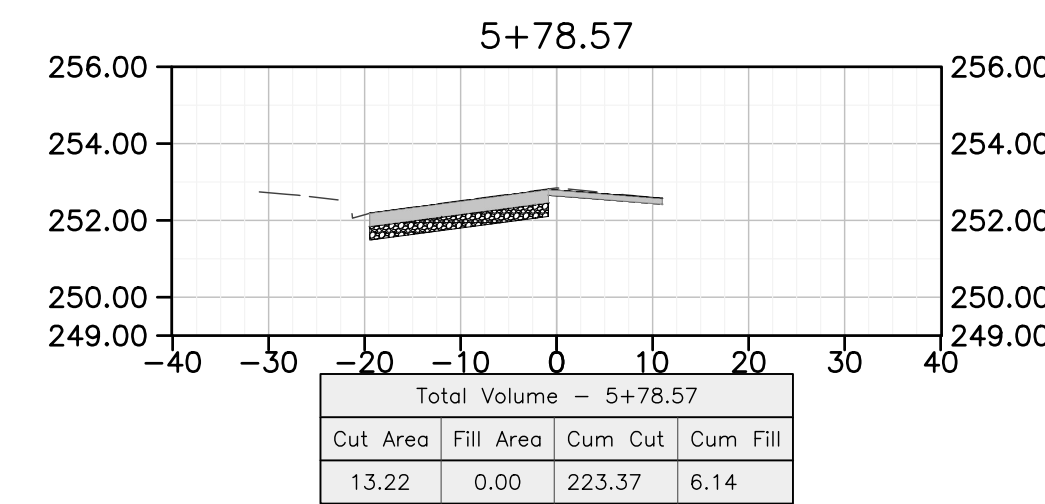
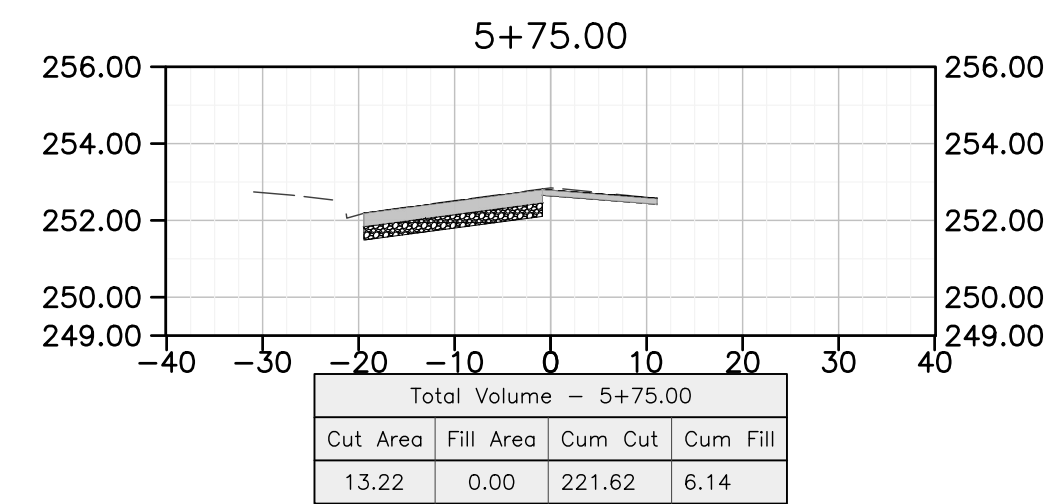
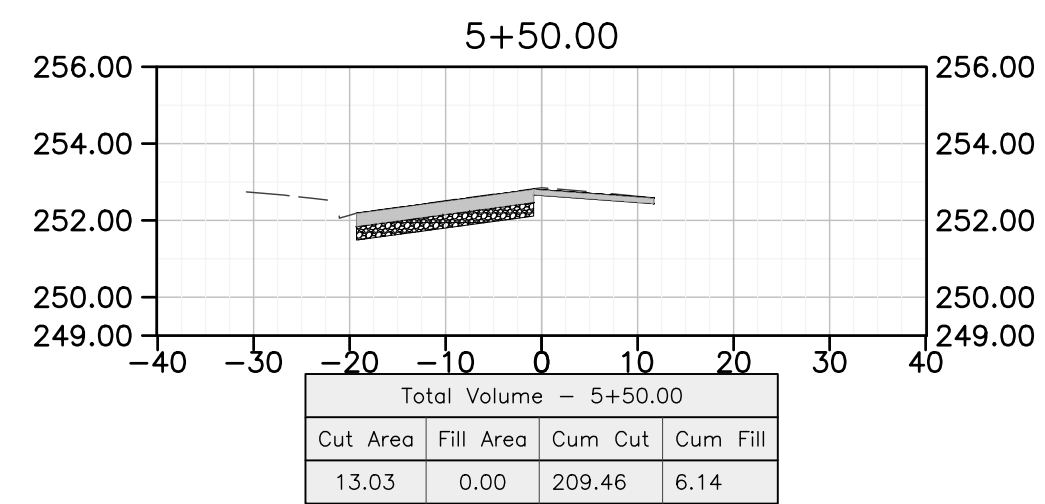
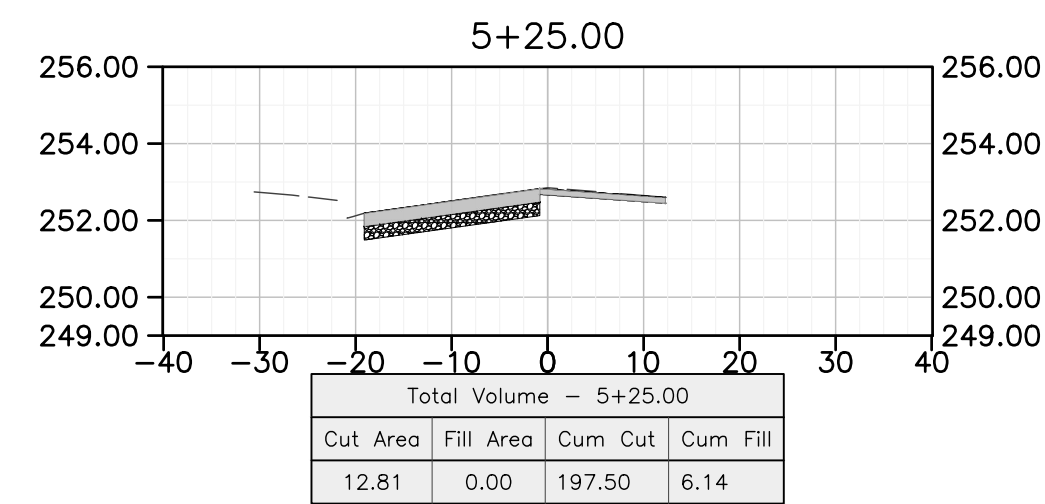
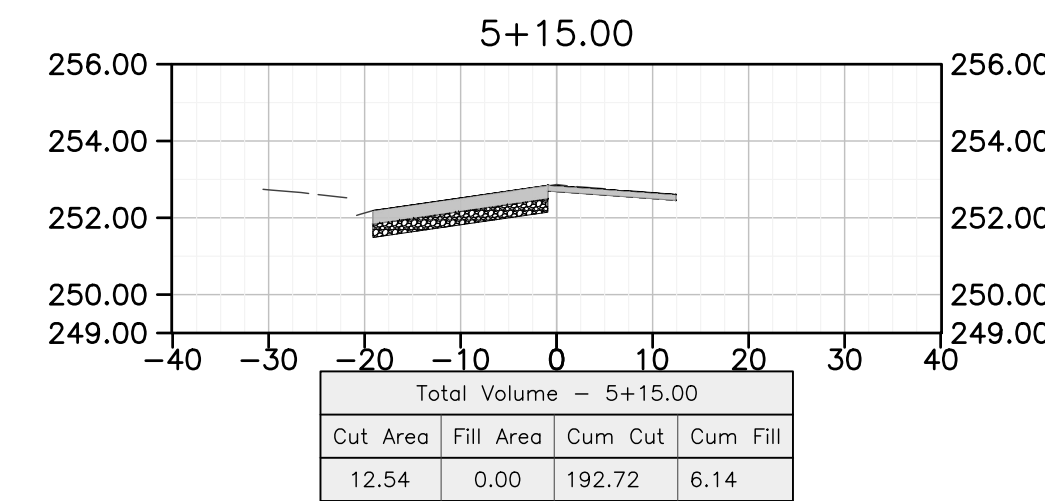
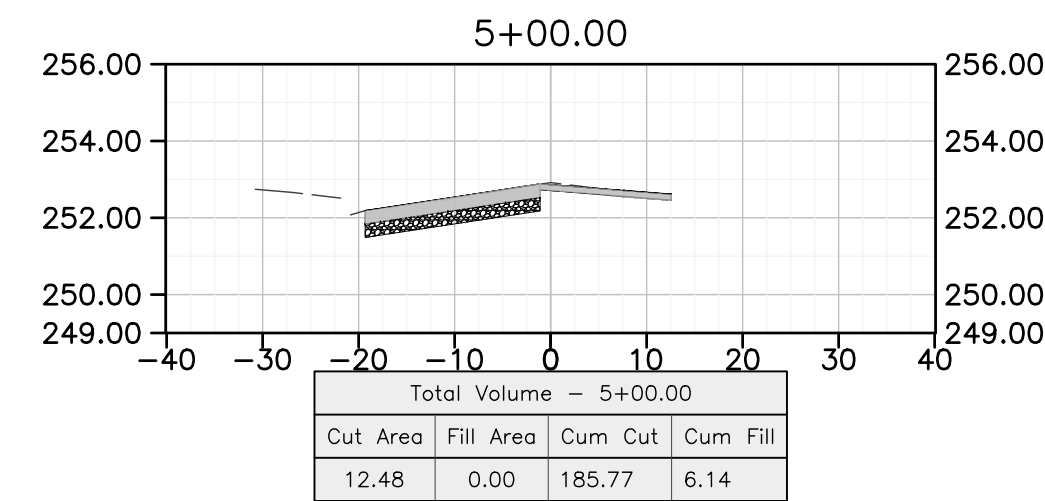
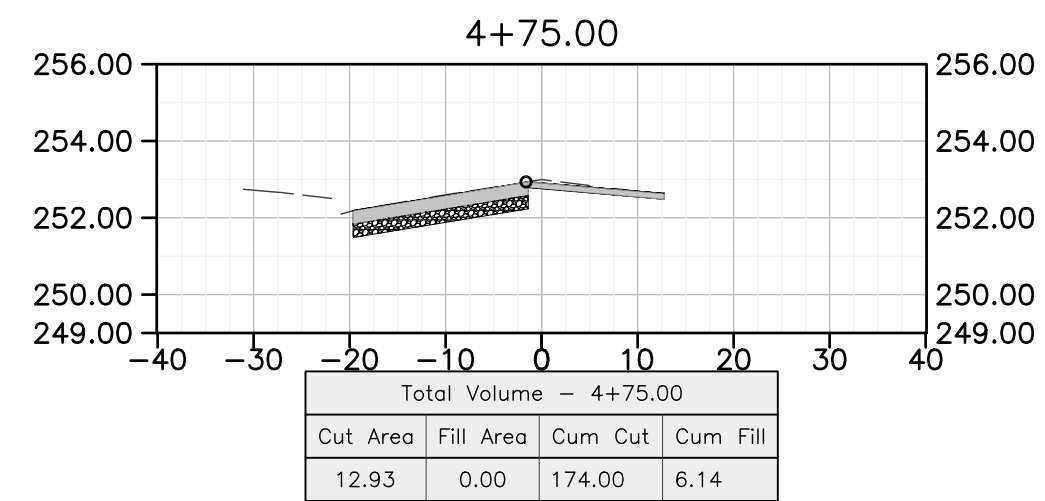
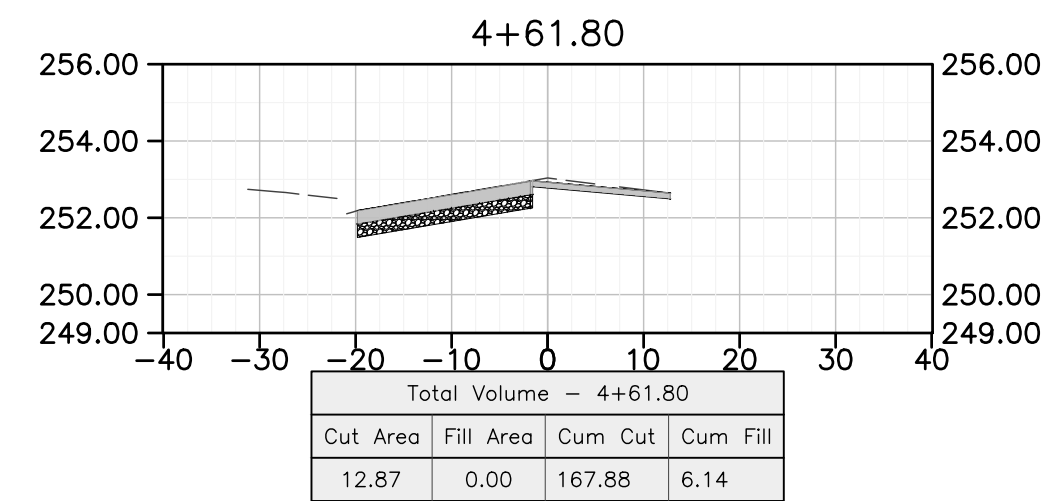
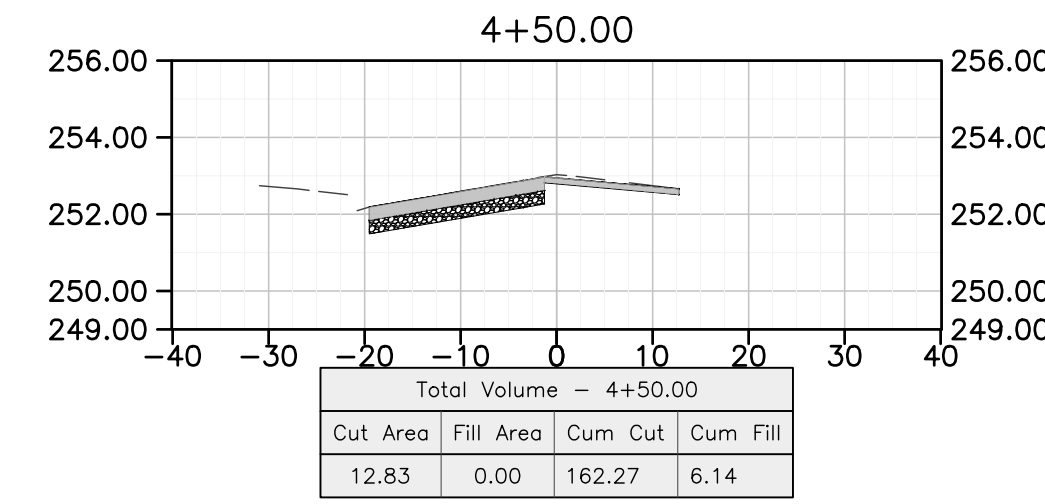
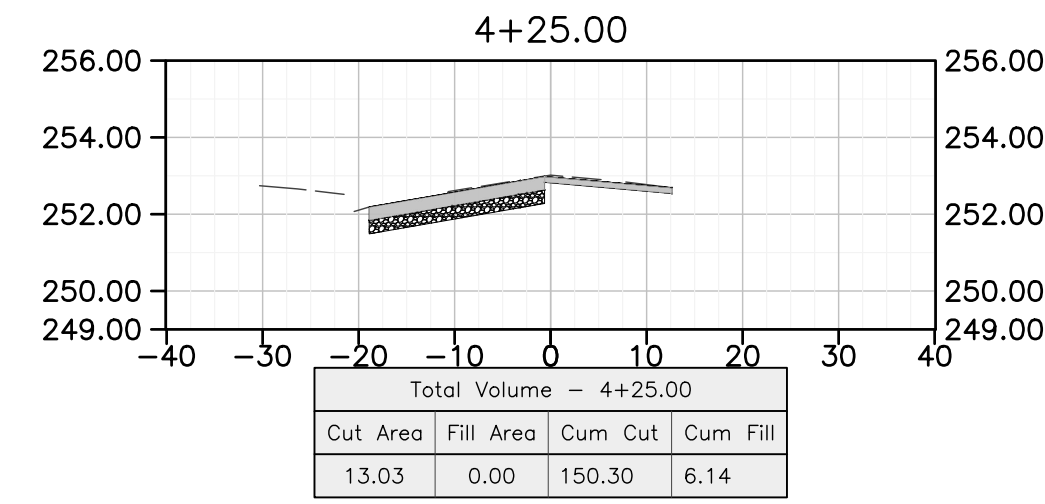
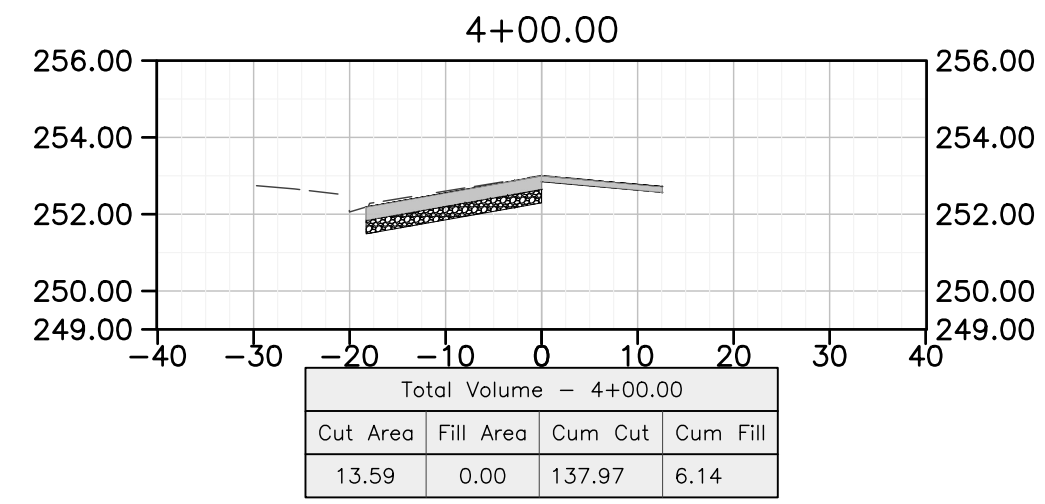
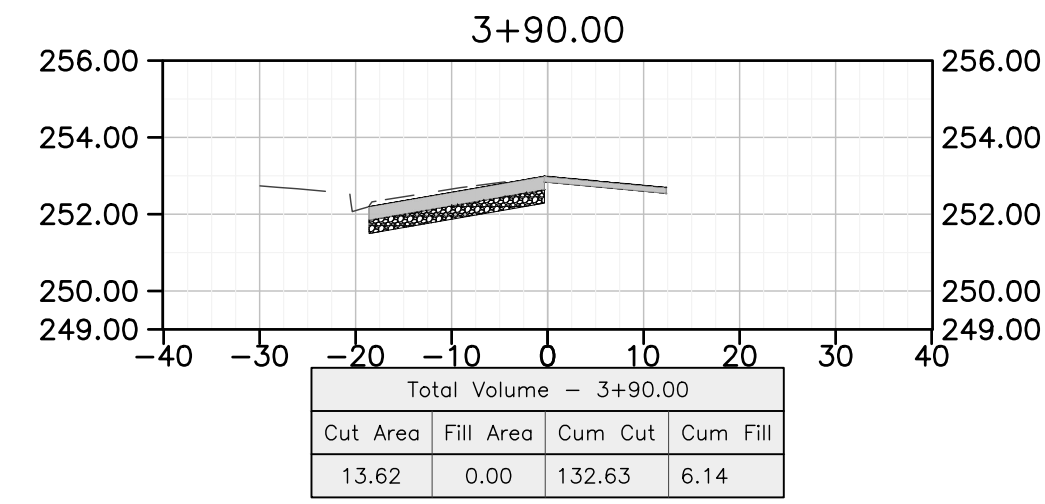

DEPARTMENT OF PUBLIC WORKS AND PLANNING

C ST. - SECTION SHEET 8

PROJECT: ATP - BIOLA COMMUNITY SIDEWALK

SCALE: 1" = 40' (HORIZ), 1" = 10' (VERT)

DESIGNED: ###, DRAWN: ###, CHECKED: ###

DATE: ###/###/###

ROAD NO. ###, BRIDGE NO. ###, DRAWING NO. ###, SHEET NO. 8, TOTAL 8

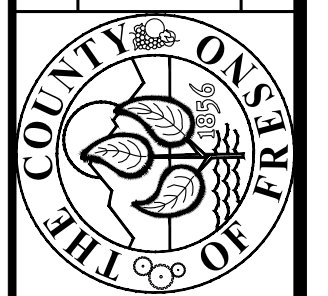

THESE CROSS SECTIONS ARE FOR THE CONTRACTOR'S INFORMATION ONLY. THEY ARE NOT TO BE CONSIDERED TO BE PART OF THE CONTRACT DOCUMENTS AND SHALL HAVE NO BEARING WHATSOEVER ON THE INTERPRETATION OF THE STANDARD SPECIFICATIONS, THE STANDARD PLANS, THE SPECIAL PROVISIONS, NOR SHALL THEY HAVE ANY BEARING WHATSOEVER ON THE INTERPRETATION OF THE OTHER PUBLICATIONS REFERENCED THEREIN.