



# County of Fresno

DEPARTMENT OF PUBLIC WORKS AND PLANNING  
STEVEN E. WHITE, DIRECTOR

DATE: October 5, 2022

TO: Development Services and Capital Projects, Attn: William M. Kettler, Division Manager  
Development Services and Capital Projects, Attn: Chris Motta, Principal Planner  
Development Services and Capital Projects, Current Planning, Attn: David Randall, Senior Planner  
Development Services and Capital Projects, Policy Planning, ALCC, Attn: Mohammad Khorsand, Senior Planner  
Development Services and Capital Projects, Zoning & Permit Review, Attn: Daniel Gutierrez; James Anders  
Development Services and Capital Projects, Site Plan Review, Attn: Gabriel Samano  
Development Services and Capital Projects, Building & Safety/Plan Check, CASp, Attn: Dan Mather  
Resources Division, Solid Waste, Attn: Amina Flores-Becker/Anniemarie Shelton  
Resources Division, Special Districts, Attn: Amina Flores-Becker/Christopher Bump  
Development Engineering, Attn: Laurie Kennedy, Grading/Mapping  
Road Maintenance and Operations, Attn: Wendy Nakagawa/Nadia Lopez  
Design Division, Transportation Planning, Attn: Augustine Ramirez/Hector Luna  
Community Development Division, Attn: Augustine Ramirez/Yvette Quiroga  
Water and Natural Resources Division, Attn: Augustine Ramirez/Roy Jimenez  
Department of Public Health, Environmental Health Division, Attn: Deep Sidhu/ Kevin Tsuda  
Fresno Metropolitan Flood Control District; Attn: [peters@fresnofloodcontrol.org](mailto:peters@fresnofloodcontrol.org); [developmentreview@fresnofloodcontrol.org](mailto:developmentreview@fresnofloodcontrol.org)  
North Kings GSA; Attn: Kassy Chauhan  
Consolidated Mosquito District; Attn: Steve Mulligon  
Pacific Gas and Electric; Attn: Dale Overbay  
Regional Water Quality Control Board, Central Valley Region, Attn: [centralvalleyfresno@waterboards.ca.gov](mailto:centralvalleyfresno@waterboards.ca.gov)  
Southern San Joaquin Valley Information Center; Attn: Celeste Thomson  
U.S. Fish and Wildlife Service, San Joaquin Valley Division, Attn: Matthew Nelson, CA Department of Fish and Wildlife, Attn: [R4CEQA@wildlife.ca.gov](mailto:R4CEQA@wildlife.ca.gov)  
Dumna Wo Wah Tribal Government, Attn: Robert Ledger, Tribal Chairman/Chris Acree, Cultural Resources Analyst  
Picayune Rancheria of the Chukchansi Indians, Attn: Heather Airey/Cultural Resources Director  
Santa Rosa Rancheria Tachi Yokut Tribe, Attn: Ruben Barrios, Tribal Chairman  
Hector Franco, Director/Shana Powers, Cultural Specialist II  
Table Mountain Rancheria, Attn: Robert Pennell, Cultural Resources Director  
California Dept. of Transportation (Caltrans), Attn: Dave Padilla/Isla Nicholas  
State Water Resources Control Board, Division of Drinking Water, Attn: Jose Robeldo/Cinthia Reyes,  
Clovis Unified School District; Attn: Dr. Eimear O'Brien; Jon Tenorio

San Joaquin Valley Unified Air Pollution Control District (PIC-CEQA Division),  
Attn: PIC Supervisor  
Fresno County Fire Protection District, Attn: FKU.Prevention-Planning@fire.ca.gov

FROM: Ejaz Ahmad, Planner   
Development Services and Capital Projects Division

SUBJECT: General Plan Amendment Application No. 566, Amendment Application No. 3850,  
Vesting Tentative Tract Map No. 6420, Variance Application No. 4140, Initial Study  
Application No. 8307

APPLICANT: Elegant Estates, LLC

DUE DATE: October 19, 2022

The Department of Public Works and Planning, Development Services and Capital Projects Division is reviewing the subject applications proposing to amend the Land Use Element of the Fresno County General Plan by changing the land use designation of a 15.24-acre parcel known as Assessor Parcel Number (APN) 579-060-37 and a 21.18-acre parcel known as APN 579-060-55 from Agricultural to Rural Residential; change the zoning of the subject parcels from the AE-20 (Exclusive Agricultural, 20-acre minimum parcel size) Zone District to the R-R (Rural Residential, two-acre minimum parcel size) Zone District, allow a Vesting Tentative Tract Map with the subdivision of subject parcels into 18 single-family residential lots; and waive public road frontage requirement for the lots in the RR Zone District.

The Department is also reviewing for environmental effects, as mandated by the California Environmental Quality Act (CEQA) and for conformity with plans and policies of the County.

Based upon this review, a determination will be made regarding conditions to be imposed on the project, including necessary on-site and off-site improvements.

We must have your comments by **October 19, 2022**. Any comments received after this date may not be used.

**NOTE - THIS WILL BE OUR ONLY REQUEST FOR WRITTEN COMMENTS. If you do not have comments, please provide a "NO COMMENT" response to our office by the above deadline .**

Please address any correspondence or questions related to environmental and/or policy/design issues to me, Ejaz Ahmad, Planner, Development Services and Capital Projects Division, Fresno County Department of Public Works and Planning, 2220 Tulare Street, Sixth Floor, Fresno, CA 93721, or call (559) 600-4204 or email eahmad@fresnocountyca.gov.

EA

G:\4360Devs&Pln\PROJSEC\PROJDOCS\VA\3800-3899\3850 - See GPA566, VA 4140, TTM 6420\ROUTING\VA 3850 Routing Ltr.doc

*Activity Code (Internal Review): 2361*

Enclosures



Fresno County Department of Public Works and Planning

Date Received:

GPA 566; AA 3850
TTM 6420
VA 4140
(Application No.)

MAILING ADDRESS:
Department of Public Works and Planning
Development Services Division
2220 Tulare St., 6th Floor
Fresno, Ca. 93721

LOCATION:
Southwest corner of Tulare & "M" Streets, Suite A
Street Level
Fresno Phone: (559) 600-4497
Toll Free: 1-800-742-1011 Ext. 0-4497

APPLICATION FOR:

- Pre-Application (Type) Map
Amendment Application
Amendment to Text
Conditional Use Permit
Variance (Class )/Minor Variance
Site Plan Review/Occupancy Permit
No Shoot/Dog Leash Law Boundary
General Plan Amendment/Specific Plan/SP Amendment
Time Extension for

DESCRIPTION OF PROPOSED USE OR REQUEST:

The proposed Tract Map will contain approximately 18 (2 ± acre) single-family lots on approximately 38 acres of land, which will be privately gated.

CEQA DOCUMENTATION: Initial Study PER N/A

PLEASE USE FILL-IN FORM OR PRINT IN BLACK INK. Answer all questions completely. Attach required site plans, forms, statements, and deeds as specified on the Pre-Application Review. Attach Copy of Deed, including Legal Description.

LOCATION OF PROPERTY: NW side of Friant Road
between Friant Road and Willow Avenue
Street address: 12760 and 12762 North Friant, Fresno, CA 93650

APN: 579-060-37 (Parcel One) Parcel size: approx. 38 acres Section(s)-Twp/Rg: S 1 - T 12 S/R 20 E

ADDITIONAL APN(s): and 579-060-55 (Parcel Two) approx. 15 acres

I, Susan Oliveira (signature), declare that I am the owner, or authorized representative of the owner, of the above described property and that the application and attached documents are in all respects true and correct to the best of my knowledge. The foregoing declaration is made under penalty of perjury.

Susan Oliveira, Trustee of th Susan P. Erickson Revocable Living Trust rso@windstream.net (559)908-4973

Table with 5 columns: Owner (Print or Type), Address, City, Zip, Phone. Rows include ELEGANT ESTATES, LLC and Austin Ewell.

CONTACT EMAIL: austin@ewellgroup.com

OFFICE USE ONLY (PRINT FORM ON GREEN PAPER)

Application Type / No.: GPA 566; AA 3850; Fee: \$ 24,979.00
Application Type / No.: TTM 6420; VA 4140 Fee: \$
Application Type / No.: Pre-app Credit Fee: \$ -247.00
Application Type / No.: PER/Initial Study No. IS 8307 Fee: \$ 5,151.00
Ag Department Review: Fee: \$ 101.00
Health Department Review: Fee: \$ 2,637.00
Received By: EJA Invoice No.: TOTAL: \$ 32,621.00

UTILITIES AVAILABLE:

WATER: Yes [ ] / No [ ]
Agency:
SEWER: Yes [ ] / No [ ]
Agency:

STAFF DETERMINATION: This permit is sought under Ordinance Section:

Sect-Twp/Rg: - T S/R E

Related Application(s): N/A

Zone District: AE-20

Parcel Size: 36.42 ACRES (Total)



Development Services  
and  
Capital Projects  
Division

**Pre-Application Review**

Department of Public Works and Planning

NUMBER: 22-001541  
 APPLICANT: ELEGANTE ESTATES, LLC  
 PHONE: (559) 251-5592

PROPERTY LOCATION: 12730 N. FRIANT RD  
 APN(s): 579-060-37 & 579-060-55 ALCC: No  Yes #        VIOLATION NO. NO  
 CNEL: No  Yes        (level) LOW WATER: No        Yes  WITHIN 1/2 MILE OF CITY: No        Yes  FRESNO  
 ZONE DISTRICT: AE-20 ; SRA: No  Yes        HOMESITE DECLARATION REQ'D.: No        Yes

LOT STATUS:  
 Zoning: (  ) Conforms; (  ) Legal Non-Conforming lot; ( ) Deed Review Req'd (see Form #236)  
 Merger: May be subject to merger: No  Yes        ZM#        Initiated        In process         
 Map Act: ( ) Lot of Rec. Map; ( ) On '72 rolls; (  ) Other       ; ( ) Deeds Req'd (see Form #236)  
 SCHOOL FEES: No  Yes        DISTRICT: CLOVIS UNIFIED PERMIT JACKET: No  Yes   
 FMFCD FEE AREA: ( ) Outside (  ) District No.: DN FLOOD PRONE: No  Yes         
**PROPOSAL GENERAL PLAN AMENDMENT, AMENDMENT APPLICATION TO REZONE FROM AE-20 TO RR ZONE DISTRICT, VARIANCE TO WAIVE PUBLIC ROAD FRONTAGE AND A TENTATIVE TRACT TO ALLOW THE CREATION OF PRIVATE GATED 18- 2 ACRE LOTS SUBDIVISION, IF APPROVED MAPPING PROCEDURE IN THEIR CREATION.**

COMMENTS:  
 ORD. SECTION(S): 816 - 820 BY: ALBERT AGUILAR DATE: 2/3/22

GENERAL PLAN POLICIES:  
 LAND USE DESIGNATION: Agriculture (  ) GPA: Re-GPA \$500.00 ( ) MINOR VA:         
 COMMUNITY PLAN:        (  ) AA: \$6,214.00 (  ) HD: \$2,637.00  
 REGIONAL PLAN:        ( ) CUP:        (  ) AG COMM: \$101.00  
 SPECIFIC PLAN:        ( ) DRA:        ( ) ALCC:         
 SPECIAL POLICIES:        (  ) VA: \$6,049.00 (  ) IS/PER\*: \$5,151.00  
 SPHERE OF INFLUENCE:        ( ) AT:        ( ) Viol. (35%):         
 ANNEX REFERRAL (LU-G17/MOU):        (  ) TT: \$12,716.00 (  ) Other: See Pre-App letter  
 Filing Fee: \$32,368.00  
 Pre-Application Fee:        - \$247.00  
 Total County Filing Fee: \$32,621.00

FILING REQUIREMENTS: OTHER FILING FEES:  
 (  ) Land Use Applications and Fees (  ) Archaeological Inventory Fee: \$75 at time of filing  
 (  ) This Pre-Application Review form (Separate check to Southern San Joaquin Valley Info. Center)  
 (  ) Copy of Deed / Legal Description (  ) CA Dept. of Fish & Wildlife (CDFW): (\$50+\$2,480.25)  
 (  ) Photographs (Separate check to Fresno County Clerk for pass-thru to CDFW.  
 ( ) Letter Verifying Deed Review Must be paid prior to IS closure and prior to setting hearing date.)  
 (  ) IS Application and Fees\* \* Upon review of project materials, an Initial Study (IS) with fees may be required.  
 (  ) Site Plans - 4 copies (folded to 8.5"x11") + 1 - 8.5"x11" reduction  
 (  ) Floor Plan & Elevations - 4 copies (folded to 8.5"x11") + 1 - 8.5"x11" reduction  
 ( ) Project Description / Operational Statement (Typed)  
 (  ) Statement of Variance Findings  
 ( ) Statement of Intended Use (ALCC)  
 ( ) Dependency Relationship Statement  
 ( ) Resolution/Letter of Release from City of         
 ( ) Nitrogen Loading Analysis or RWQCB supplemental treatment

BY: Thomas Kobayashi DATE: 2/8/21  
 PHONE NUMBER: (559) 620 - 4224

NOTE: THE FOLLOWING REQUIREMENTS MAY ALSO APPLY:  
 ( ) COVENANT ( ) SITE PLAN REVIEW  
 ( ) MAP CERTIFICATE (  ) BUILDING PLANS  
 ( ) PARCEL MAP (  ) BUILDING PERMITS  
 (  ) FINAL MAP ( ) WASTE FACILITIES PERMIT  
 (  ) FMFCD FEES (  ) SCHOOL FEES  
 ( ) ALUC or ALCC ( ) OTHER (see reverse side)

PLU # 113 Fee: \$247.00  
 Note: This fee will apply to the application fee if the application is submitted within six (6) months of the date on this receipt.

OVER.....



# LOCATION MAP



CITY OF CLOVIS

MADERA COUNTY

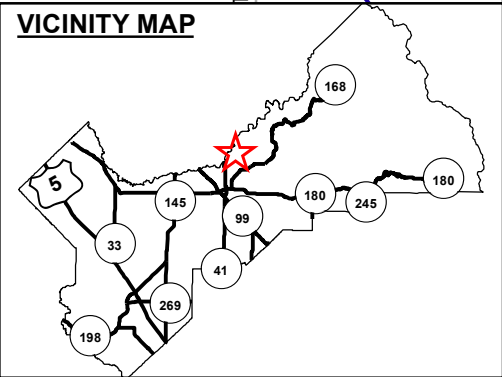
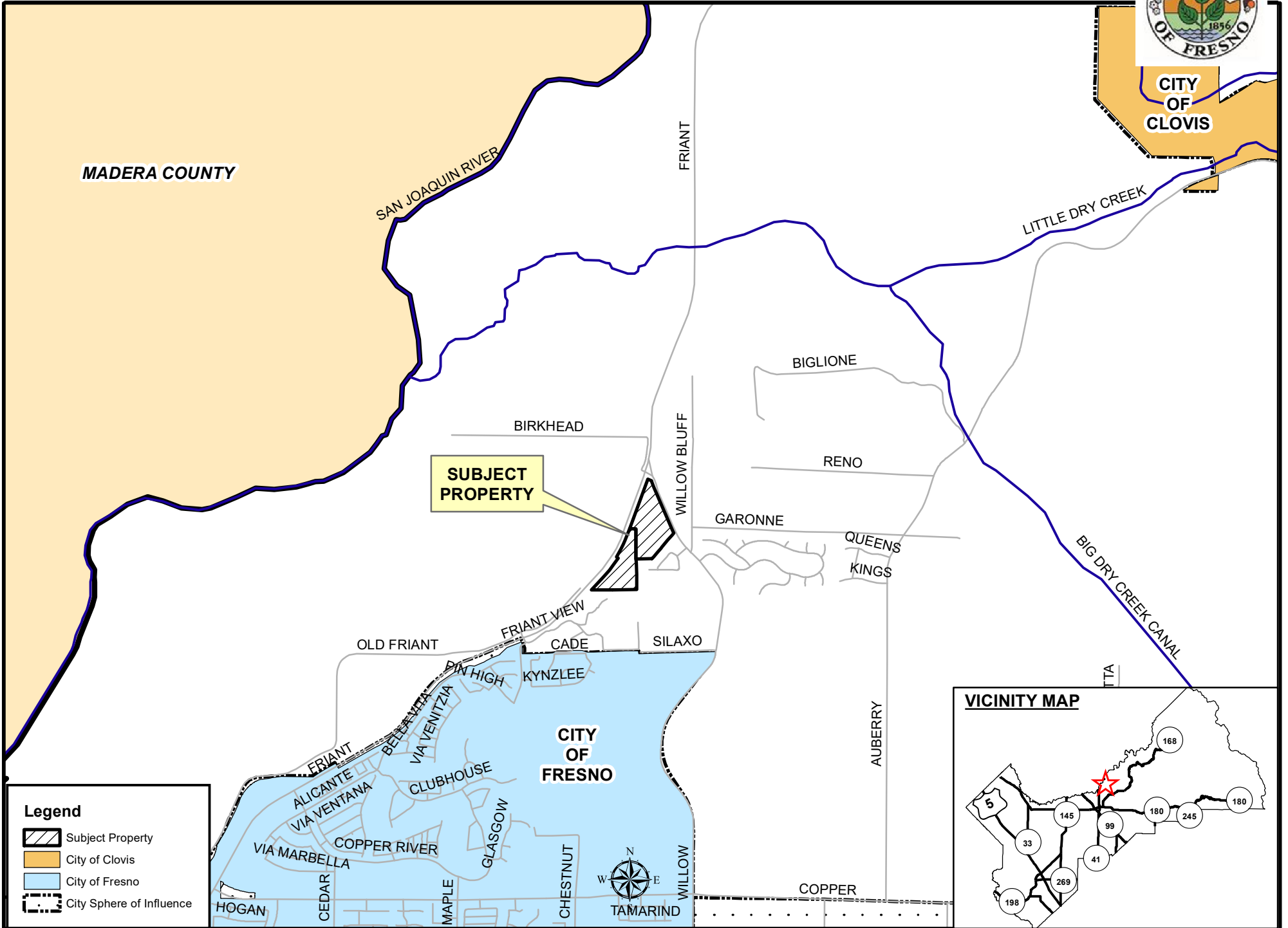



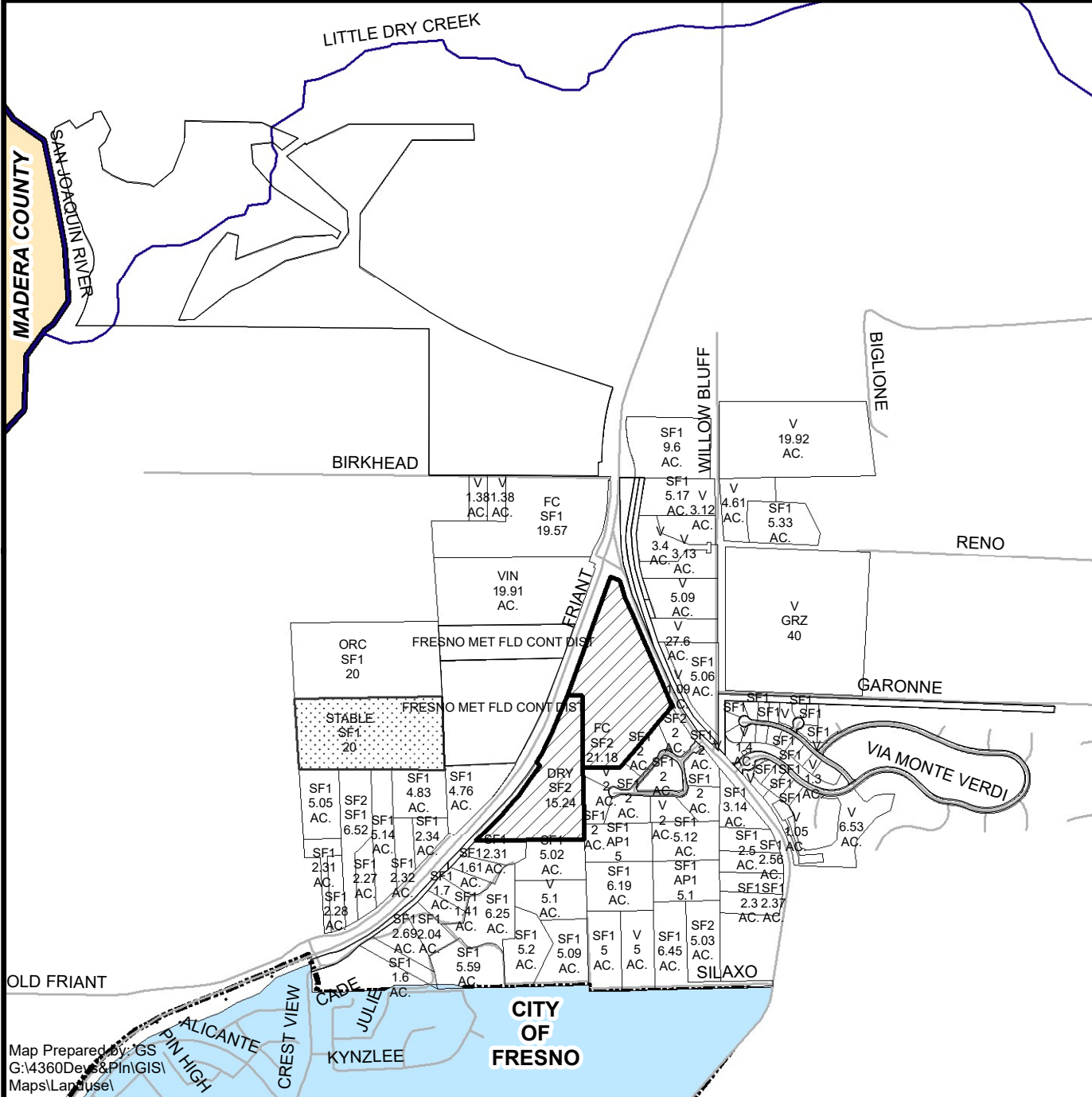

# EXISTING LAND USE MAP



LEGEND	
AP1	- APARTMENT
DRY	- DRY FARMING
FC	- FIELD CROP
GRZ	- GRAZING
ORC	- ORCHARD
SF#	- SINGLE FAMILY RESIDENCE
V	- VACANT
VIN	- VINEYARD

## Legend

-  Subject Property
-  Ag Contract Land
-  City of Fresno
-  City of Fresno Sphere of Influence

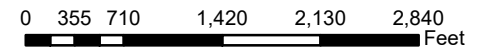

# EXISTING ZONING MAP

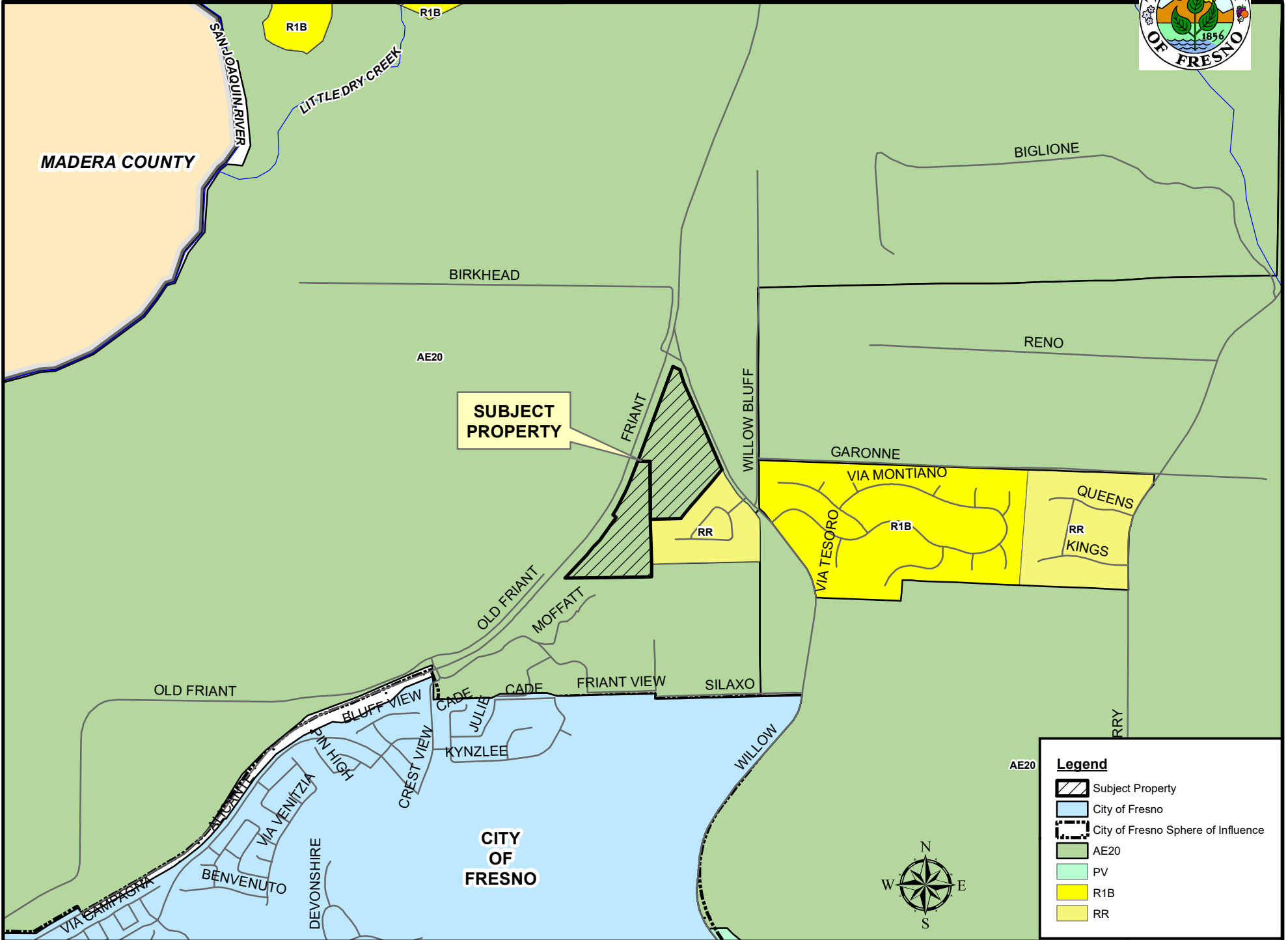

It is not to be construed as portraying legal ownership or divisions of land for purposes of zoning or subdivision law.

POR. SEC. 1 & 12, T.12S., R.20E., & POR. SEC. 7, T.12S., R.21E., M.D.B.&M.

579-0

Agricultural Preserve  
Parcel Map No. 917 - Bk. 8, Pg. 33  
Parcel Map No. 1160 - Bk. 7, Pg. 14  
Parcel Map No. 1876 - Bk. 11, Pg. 45  
Parcel Map No. 3531 - Bk. 27, Pg. 19  
Parcel Map No. 6293 - Bk. 42, Pg. 45  
Parcel Map No. 6531 - Bk. 43, Pg. 5  
Parcel Map No. 8116 - Bk. 72, Pgs. 72 - 73

Record of Survey - Bk. 46, Pg. 98  
Record of Survey - Bk. 48, Pg. 02  
Record of Survey - Bk. 50, Pg. 83  
Tract No. 4710, Plat Bk. 61, Pgs. 39-42

Tax Rate Area  
76-005  
76-019  
76-084

N  
1"=400'

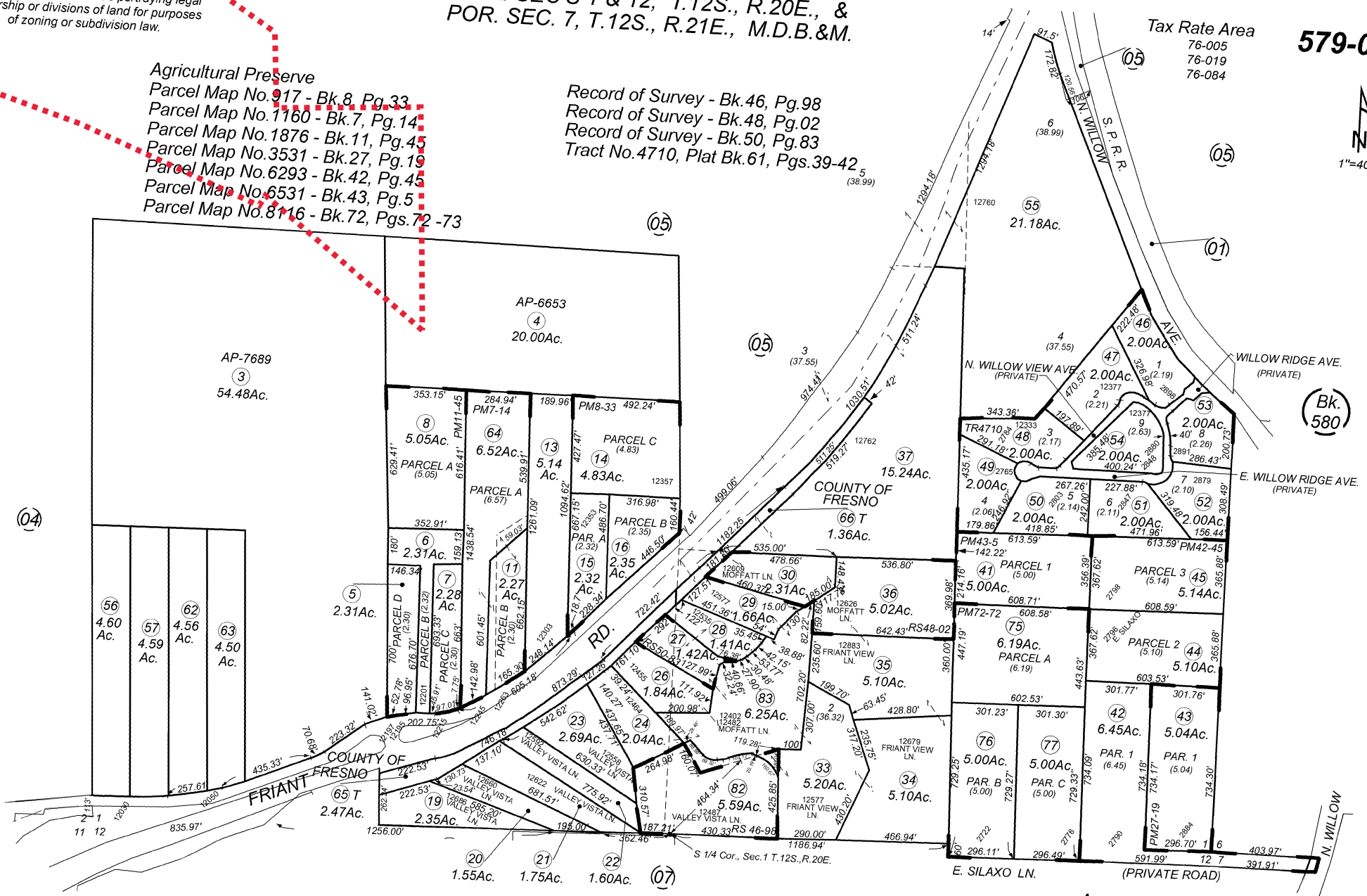

10/2/2018

Note - Assessor's Block Numbers Shown in Ellipses  
Assessor's Parcel Numbers Shown in Circles

Assessor's Map Bk. 579 - Pg. 06  
County of Fresno, Calif.



PROJECT

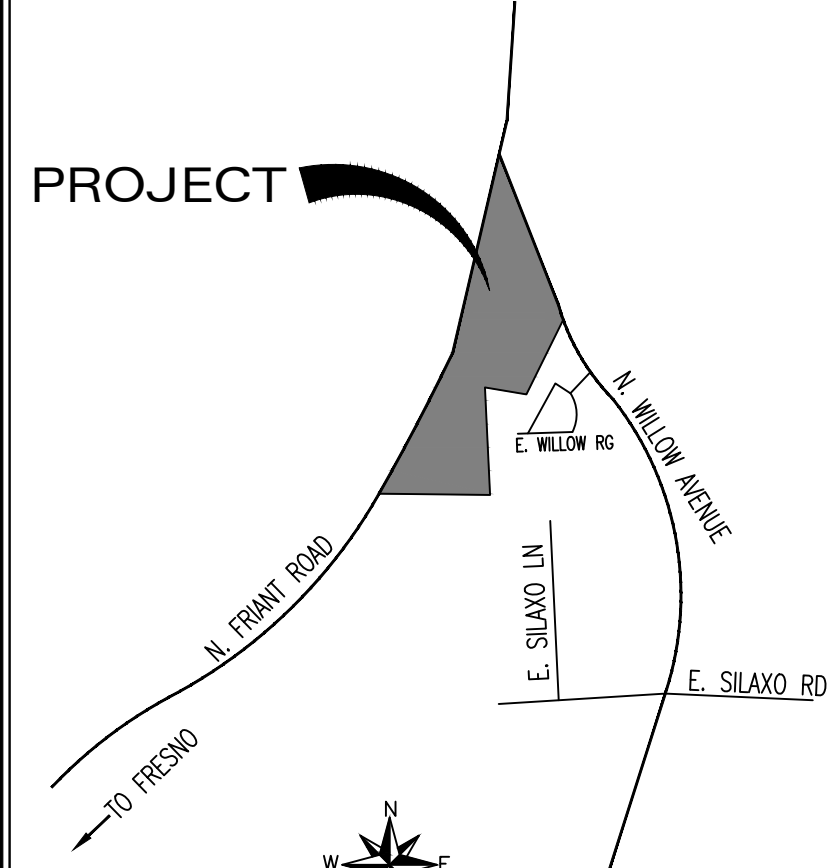

VICINITY MAP  
(NOT TO SCALE)

LEGEND

- PARCEL MAP/TRACT PROPERTY BOUNDARY
- - - STREET R/W
- CENTERLINE
- · - · - PROPOSED/EXISTING EASEMENTS
- EXISTING BUILDING/SHADE PERIMETER
- · - · - PROPOSED LOT

LEGEND - EXISTING

- NOTE: NOT ALL EXISTING SYMBOLS IN PLANS MAY BE SHOWN HERE
- |        |                                  |   |   |
|--------|----------------------------------|---|---|
| W12    | EX WATER MAIN & PIPE SIZE        | ⊙ | EX STORM DRAIN MANHOLE                  |
| SS12   | EX SANITARY SEWER & PIPE SIZE    | ⊙ | EX SEWER MANHOLE                        |
| SD15   | EX STORM DRAIN & PIPE SIZE       | ⊙ | EX UTILITY POLE                         |
| C      | EX BURIED COMMUNICATION LINE     | ⊙ | EX FIRE HYDRANT                         |
| T      | EX BURIED TELEPHONE LINE         | ⊙ | EX WATER METER                          |
| G      | EX BURIED ELECTRICAL LINE        | ⊙ | EX WATER VALVE                          |
| OH     | EX BURIED GAS PIPE               | ⊙ | EX FIRE WATER/DOMESTIC WATER FACILITIES |
| IRP 30 | EX BURIED IRRIGATION & PIPE SIZE | ⊙ | EX TREE                                 |
| OH     | EX OVERHEAD UTILITY              | ⊙ | EX CHAINLINK FENCING                    |
| FO     | EX BURIED FIBER OPTICS           | ⊙ | EX IRON FENCING                         |
| UU     | EX UNKNOWN UTILITY TYPE          | ⊙ | EX CENTERLINE/SECTION LINE              |
| ⊙      | EX GAS METER                     | ⊙ | EX PROPERTY LINE                        |
| ⊙      | EX SEWER CLEANOUT                | ⊙ | EX EASEMENT LINE                        |
| ⊙      | EX SIGNAGE                       | ⊙ | EX RELINQUISHMENT OF ACCESS             |
| ⊙      | EX TELEPHONE PEDestal/BOX        | ⊙ | EX CONCRETE                             |
| ⊙      | EX ELECTRICAL PULL BOX           | ⊙ | EX ASPHALT PAVEMENT                     |
| ⊙      | EX ELECTRICAL VAULT              | ⊙ | EX MAILBOX                              |
| ⊙      | EX ELECTRICAL PAD MOUNTED        | ⊙ | EX BLOCK WALL                           |
| ⊙      | EX CUY WIRE                      | ⊙ | EX CURB INLET                           |
| ⊙      | EX STREET LIGHT                  | ⊙ | EX CURB & GUTTER                        |
| ⊙      | EX STREET LIGHT ON WOOD POLE     | ⊙ | EX CURB                                 |
| ⊙      | EX POLE LIGHT                    | ⊙ | EX EDGE OF PAVEMENT                     |

APPLICANT/SUBDIVIDER  
ELEGANTE ESTATES, LLC  
N. FAIRFAX AVENUE  
CLOVIS, CA 93612

RECORD OWNER  
SUSAN P. ERICKSON, TRUSTEE OF SUSAN P. ERICKSON FINANCIAL TITLE COMPANY  
FRESNO FIRST BANK

ENGINEER  
HAL LORE, PE  
LORE ENGINEERING, INC.  
620 DEWITT AVENUE, SUITE 101  
CLOVIS, CA 93612  
(559) 297-5200 EXT: 1

LEGAL DESCRIPTION

PARCEL A: (APN: 579-060-37)  
THAT PORTION OF THE NORTHWEST QUARTER OF THE SOUTHWEST QUARTER OF SECTION 1, TOWNSHIP 12 SOUTH, RANGE 20 EAST, MOUNT DIABLO BASE AND MERIDIAN, IN THE COUNTY OF FRESNO, STATE OF CALIFORNIA, ACCORDING TO THE OFFICIAL PLAT THEREOF, LYING EAST OF THE CENTER LINE OF THE FRONT ROAD. EXCEPTING THEREFROM THAT PORTION CONVEYED TO THE COUNTY OF FRESNO, RECORDED JUNE 4, 1968 IN BOOK 5576, PAGE 688 AS INSTRUMENT NO. 39318 OF OFFICIAL RECORDS.

PARCEL B: (APN: 579-060-55)  
THAT PORTION OF THE EAST HALF OF SECTION 1, TOWNSHIP 12 SOUTH, RANGE 20 EAST, MOUNT DIABLO BASE AND MERIDIAN, DESCRIBED AS FOLLOWS: BEGINNING AT THE SOUTHWEST CORNER OF FRACTIONAL NORTHWEST QUARTER OF THE SOUTHWEST QUARTER OF SECTION 1, TOWNSHIP 12 SOUTH, RANGE 20 EAST, MOUNT DIABLO BASE AND MERIDIAN, SAID POINT OF BEGINNING BEING THE SOUTHWEST CORNER OF THE LAND GRANTED TO WILMA A. BALL BY DEED RECORDED MAY 24, 1966 IN BOOK 5316 PAGE 672 OF OFFICIAL RECORDS, DOCUMENT NO. 39557; THENCE WESTERLY, ALONG THE SOUTH BOUNDARY OF THE FRACTIONAL NORTHWEST QUARTER OF THE SOUTHWEST QUARTER OF SAID SECTION 1, TO A POINT 11.00 FEET EAST OF THE SOUTHWEST CORNER OF THE FRACTIONAL NORTHWEST QUARTER OF THE SOUTHWEST QUARTER OF SAID SECTION 1, SAID COUNTY ROAD RUNNING NORTHEASTERLY THROUGH SAID SECTION 1; THENCE FOLLOWING THE CENTER LINE OF SAID ROAD AS FOLLOWS, NORTH 48°19' EAST, 189.00 FEET; NORTH 47°52' EAST, 293.00 FEET; NORTH 36°19' EAST, 287.00 FEET; NORTH 36°13' EAST, 229.00 FEET; NORTH 32°20' EAST, 296.00 FEET; NORTH 24°24' EAST, 577.00 FEET; NORTH 14°27' EAST, 426.00 FEET; NORTH 14°01' EAST, 298.00 FEET; NORTH 30°23' EAST, 122.00 FEET; NORTH 15°44' EAST, 125.00 FEET TO THE INTERSECTION WITH THE CENTER LINE OF A CERTAIN ROAD RUNNING SOUTHEASTERLY THROUGH SAID SECTION 1; THENCE FOLLOWING THE CENTER LINE OF SAID LAST MENTIONED ROAD AS FOLLOWS: SOUTH 17°06' EAST, 158.00 FEET; SOUTH 18°37' EAST, 314.60 FEET; SOUTH 64°39' EAST, 208.70 FEET; SOUTH 45°13' EAST, 153.40 FEET; SOUTH 29°18' EAST, 140.00 FEET; SOUTH 20°30' EAST, 196.00 FEET; SOUTH 23°42' EAST, 182.00 FEET; SOUTH 39°41' EAST, 181.00 FEET; SOUTH 78°31' EAST, 73.00 FEET, TO A POINT ON THE EAST BOUNDARY OF SAID SECTION 1, 2014.40 FEET NORTH OF THE SOUTHWEST CORNER OF SAID SECTION; THENCE SOUTHERLY 511.44 FEET TO A POINT 142.25 FEET NORTHERLY FROM THE SOUTHWEST CORNER OF THE NORTHWEST QUARTER OF THE SOUTHWEST QUARTER OF SAID SECTION 1, THENCE WESTERLY TO A POINT OF THE EAST LINE OF THE NORTHWEST QUARTER OF THE SOUTHWEST QUARTER OF SAID SECTION, 142.22 FEET NORTHERLY FROM THE SOUTHWEST CORNER OF THE NORTHWEST QUARTER OF THE SOUTHWEST QUARTER OF SAID SECTION 1; THENCE SOUTHERLY TO THE POINT OF BEGINNING.

VESTING TENTATIVE TRACT MAP 6420

FOR SUBDIVISION PURPOSES  
IN THE COUNTY OF FRESNO, STATE OF CALIFORNIA

EXISTING ZONING	AE
PLANNED LAND USE	RR
PROPOSED ZONING	RR
NUMBER OF LOTS	18
SOURCE OF WATER	PRIVATE WELL
SOURCE OF SEWER DISPOSAL	PRIVATE SEPTIC SYSTEM
STORM DRAINAGE	FMFCD
GROSS ACREAGE	36.42 AC
NET ACREAGE	36.42 AC
PRIOR PLANNING ENTITLEMENT	APN: 579-060-55, APN: 579-060-37

NOTES

- PROPOSED SEWER, WATER, GAS, STORM DRAINAGE, CONCRETE CURBS, GUTTERS, AND SIDEWALKS, STREET LIGHTS, AND STREET IMPROVEMENTS TO BE INSTALLED PER COUNTY OF FRESNO STANDARD PLANS AND SPECIFICATIONS.
- THERE ARE EXISTING OVERHEAD UTILITIES OR EXISTING TREES ALONG PUBLIC RIGHTS OF WAY WITHIN THE FRONTAGE LIMITS OF THIS MAP.
- THERE ARE NO GRADE DIFFERENTIAL OF 6" OR MORE LOCATED AT PROPERTY LINES WITHIN THE LIMITS OF THIS MAP.
- THERE ARE EXISTING PRIVATE WELLS WITHIN THE LIMITS OF THIS MAP.
- THERE ARE ON-SITE EXISTING TREES WITHIN THE BOUNDARY OF THIS MAP.

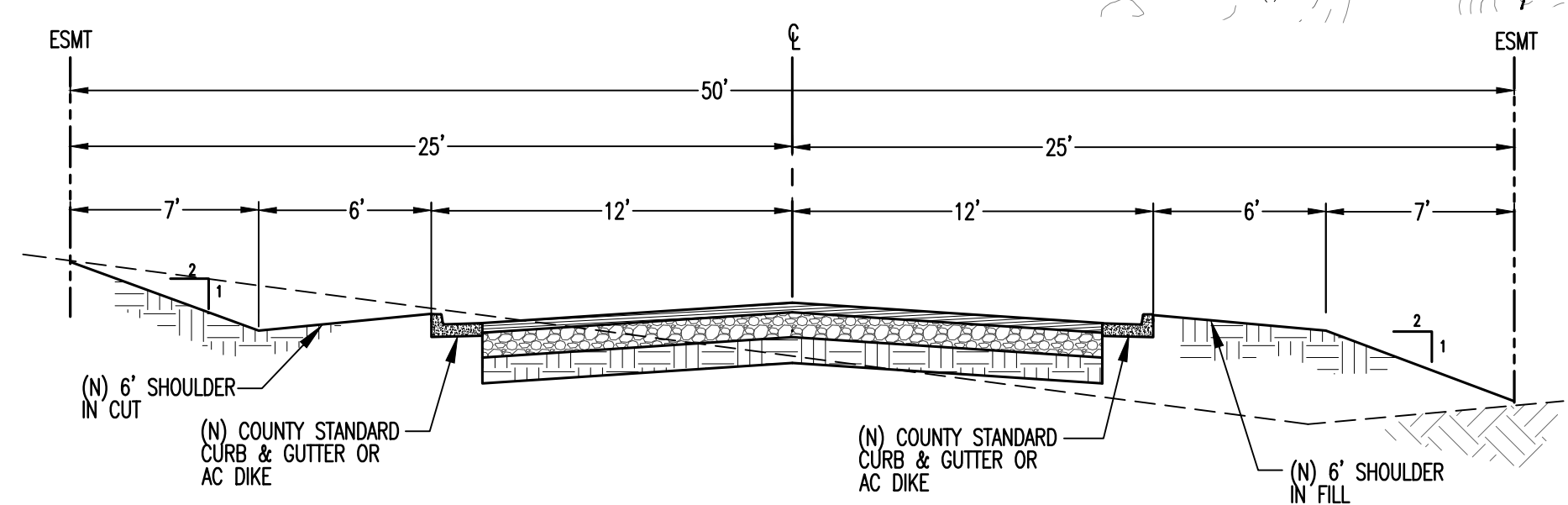
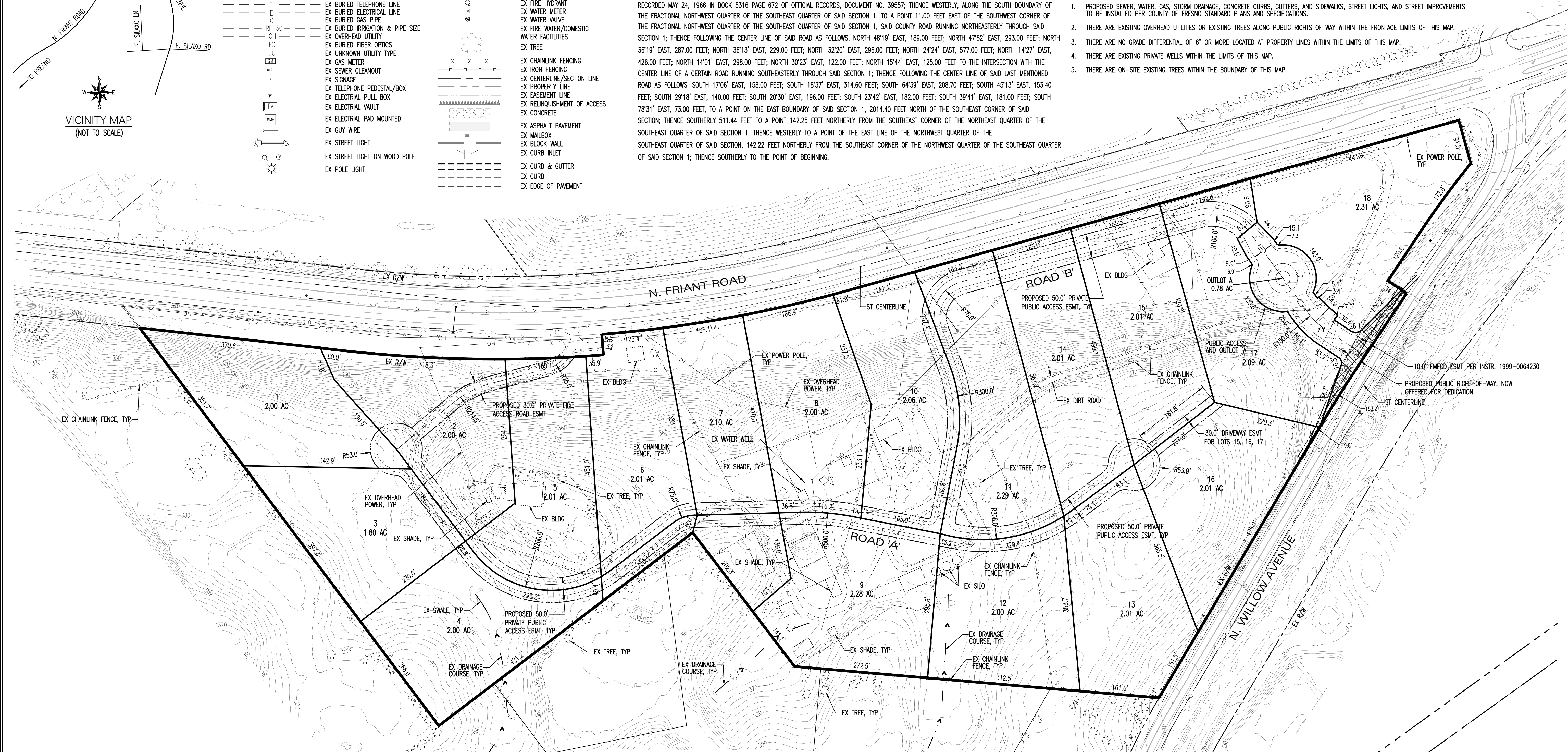

SECTION A - TYPICAL PUBLIC ACCESS  
SCALE: NTS

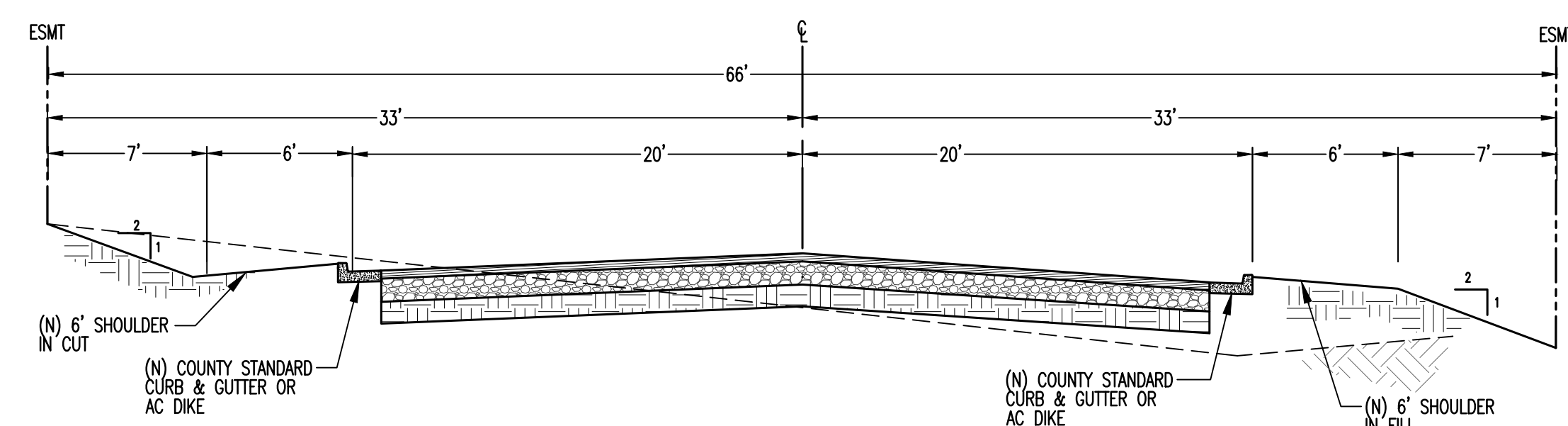

SECTION B - WILLOW AVE. ENTRY DRIVE  
SCALE: NTS

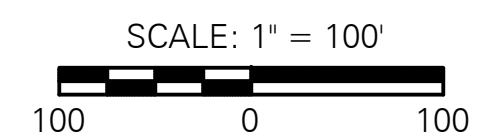

SCALE: 1" = 100'

REV.	DESCRIPTION	DATE
1		
2		
3		
4		

PREPARED BY:  
**LORE ENGINEERING, INC.**  
CIVIL ENGINEERING • CONSULTING • PLANNING  
620 DEWITT AVENUE, SUITE 101  
CLOVIS, CA 93619  
EMAIL: [HAL@LOREENGINEERING.COM](mailto:HAL@LOREENGINEERING.COM)  
[WWW.LOREENGINEERING.COM](http://WWW.LOREENGINEERING.COM)

PREPARED FOR:  
**ELEGANTE ESTATES, LLC**  
N. FAIRFAX AVENUE  
CLOVIS, CA 93612

PROJECT TITLE:  
**ELEGANTE ESTATES - TRACT 6420**

**VESTING TENTATIVE TRACT MAP**



DESIGNED BY: H. LORE  
DRAWN BY: G. XIONG  
CHECKED BY: H. LORE  
SCALE:

PROJECT: EEL.2101  
DATE: 09/01/22

**TM-1**  
SHEET 1 OF 1

D:\PROJECTS\2022\EEL 2101\Acad\Plans\Plans - Maps\EEL.2201 - Preliminary Tentative Map - Elegante Estates.dwg USER: TECH DATE: Sep 01, 2022 2:45pm



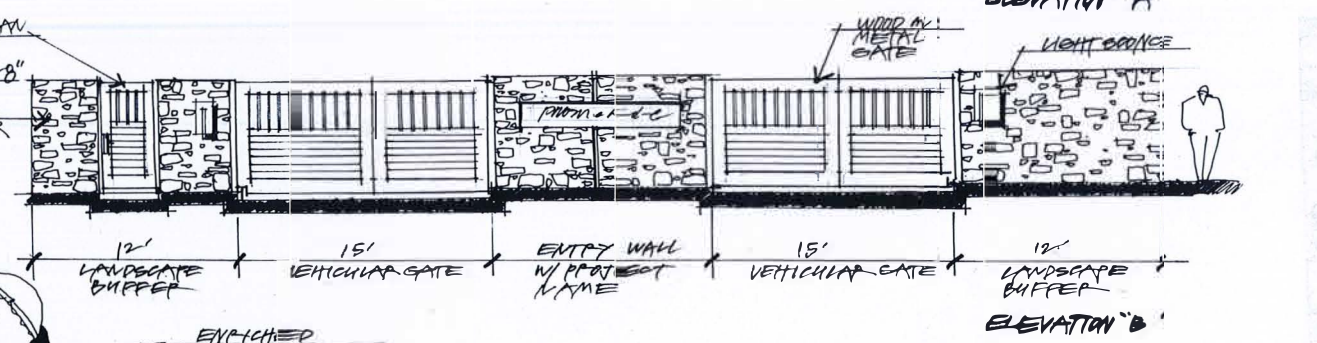
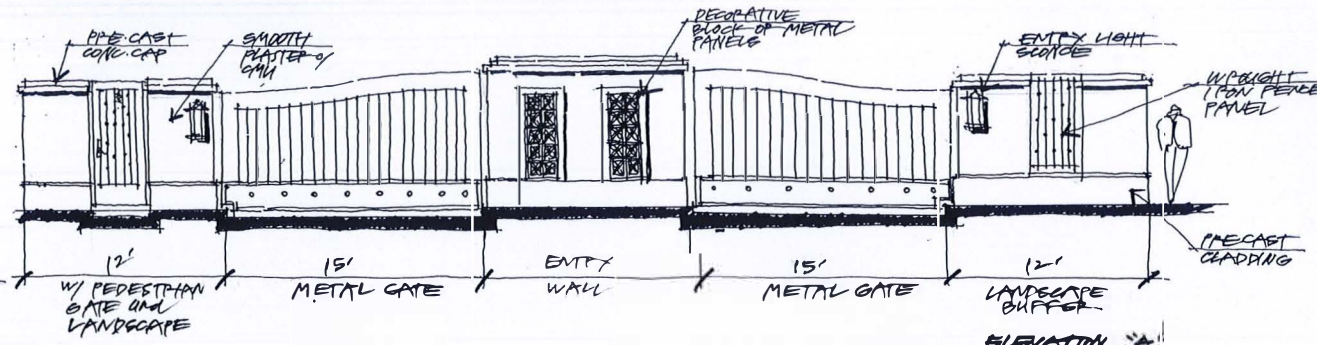
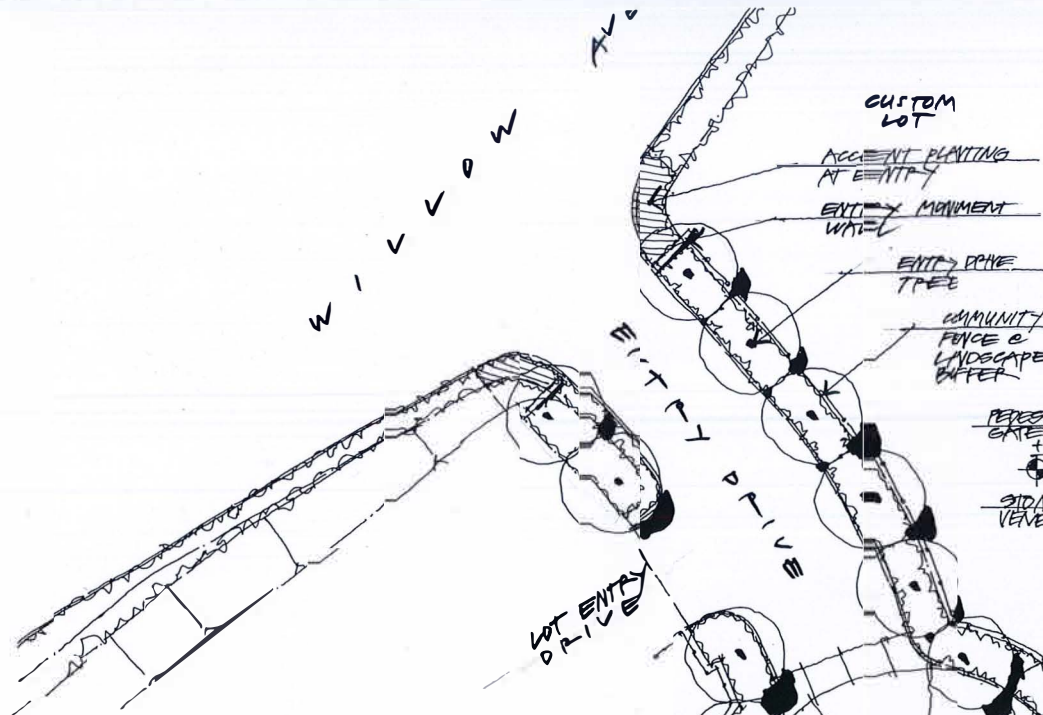

GPA 566, AA3850, TTM6420, VA4140

CUSTOM LOT

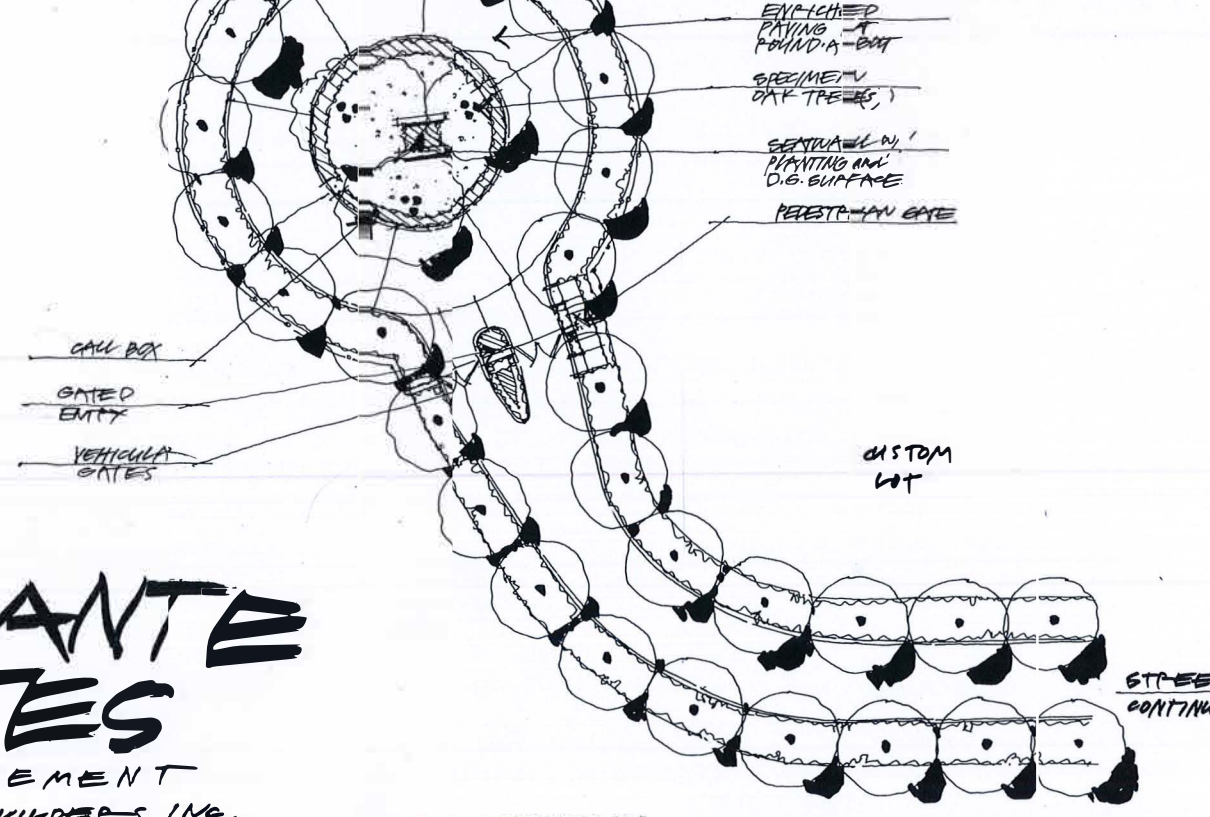

# ELEGANTE ESTATES

ENTRY ENLARGEMENT  
VALLEY PACIFIC BUILDERS INC.

CONCEPTUAL PLAN  
BRONKARD ASSOCIATES LANDSCAPE ARCHITECTS  
1"=20'

P.L. & P.M. ANT ROAD

---

# ELEGANTE ESTATES

A 18-Lot Vesting Tentative Tract Map (No. ~~6420~~)  
and

## Operational Statement

Submitted to:

Fresno County  
Department of Public Works and Planning  
2220 Tulare Street, 6th Floor  
Fresno, CA 93721

Prepared for:

Elegante Estates, LLC  
Fresno, CA  
(559)

Prepared by:

Ewell Group  
735 W. Alluvial Ave. #103  
Fresno, CA 93711  
(559) 437-1990

June 2022

---

GPA 566  
AA 3850  
TTM 6420  
VA 4140



## Operational Statement

### Project Description

This Operational Statement provides for the design framework for Vesting Tentative Tract Map 6420 for the development of 18 rural residential single-family 2-acre± lots plus an common area outlot parcel, totaling approximately 37± acres within Fresno County (Project). The Project is located on Assessors Parcel Numbers 579-060-37 and 579-060-55, at the intersection of Friant Road and Willow Avenue, approximately one and three-quarter mile north of Copper Avenue. It is bounded on the east side by Willow Avenue and adjacent to residential projects, the north by rural residential and westerly to the Cemex Concrete Plant, and on the south side by Maple Ridge Subdivision consisting of approximately 2-acre lots; on the east side by Monte Verdi Estates, a 125-lot residential subdivision; and to the west, by a mix of agriculture, residential and commercial lots<sup>1</sup>.

The Project site's current land use is agricultural and zoned as AE20. The proposed land use being requested for the project site is a rural residential designation.

The Project is comprised of 18 single family lots and outlot parcel for project-related uses in a gated area to be served by a private street system as shown on Vesting Tentative Subdivision Map No. 6420. The Project is envisioned as a gated single-family neighborhood consistent with the surrounding neighborhoods and integrated into the natural environment and open space areas. Special attention has been given to landscaping and streetscape to provide for a pleasant community lifestyle that is water conscious. The Project may have a private natural trail system meandering through the topography and maintained by the community.

The Project includes the following features:

1. The Project is within Fresno County.
2. Irrigation, including front and back yards and landscaping, will be predominantly drought tolerant.
3. Fire sprinklers will be a requirement of all residences.
4. The Property will have a natural trail system and these facilities, along with the two Project entryways and perimeter fencing, Common area gates, fences and trails will be operated and maintained by the Elegante Estates Homeowners Association (HOA).
5. Each residence at building permit will pay a one-time fee to the San Joaquin River Parkway and Conservation Trust.
6. The Project will be subject to a mitigation and monitoring matrix similar to

---

<sup>1</sup> This paragraph relates to Question #1 of the Operational Checklist provided by the County of Fresno

the adjacent communities as determined by Fresno County.

**A. Description of Residential Project**

**1. Water Supply For Potable Domestic and Irrigation**

a) Potable Water Use: The Project residential lots will be served by ground water wells to be individually owned and privately operated by each lot owner for domestic potable water supply within the Project site. The common area facilities such as trails, entrances and the outlot parcel will be served by a ground water well owned and operated by the HOA. The property has two existing ground water wells that are subject to County approved testing parameters. The project will also be subject to an onsite recharge program using storm water capture to enhance the ground water in the area.<sup>2</sup>

b) Outside Irrigation Use: The project residential lots will obtain irrigation water in conjunction with the usage of the private ground water wells to be installed by each parcel owner at the time of development. The project will incorporate a mandatory requirement that all landscape irrigation, including all front and back yards of residences, will have area limitations for each parcel or a defined boundary where landscaping can occur and leaving the remaining portion of the parcel land/perimeter in its natural state. The residents will be required to use drought tolerant landscaping for irrigation water efficiency.

**2. Fire Protection**

Fire project will consist of either fire sprinklers (in buildings) or hydrants to be located on each residential lot and to be installed by the lot owner at the time of development. Residential lots shall conform to County and Calfire standards, which generally will consist of internal building fire sprinkler and pressurized (or draft-only type) fire hydrants serving each lot. A common use fire protection water system, such as an internal buried water main in the roadway, will not be utilized as each property will be required to be developed such that private on-site hydrants can provide the means for fire protection on the individual lots. Fire sprinklers will be a requirement of all residential units. Fire flow and storage requirements of the permitting agency will be met with the use of the private onsite lot well and/or a private water storage system. Where fire protection facilities are constructed for the common area facilities, each residential unit will pay an annual fee for the operation and maintenance of the common area fire-related facilities.

---

<sup>2</sup> This paragraph relates to Question #13 of the Operational Checklist provided by the County of Fresno

### **3. Open Space and Natural Trail System Plan**

The Project will be part of the Elegante HOA Open Space and Natural Trail System Plan and each residential unit will pay a fee per unit and pay such additional fees for onsite and offsite mitigation and maintenance as may be reasonably required. At the developers option, such open space and trail areas may be reserved by covenant or easement through each lot in favor of the HOA.

### **4. Mitigation and Monitoring Matrix**

The Project will be subject to a Mitigation and Monitoring Matrix as set forth by Fresno County.

### **5. Air Quality**

An Air Quality Impact Analysis has been prepared by VRPA, a local air quality consultant, for the Project. The Project will be subject to certain impact fees as provided in the Indirect Source Rules recently adopted by the Air District.

### **6. Neighborhood Character**

The neighborhood setting provides both privacy and convenience compatible with the site's natural setting and neighboring communities. Homes will be designed with special attention given to creating a strong relationship to each other which will strive to capture views and the terrain of the natural setting. The project will require that each property owner approval from the HOA of the building character, aesthetics and site location to confirm consistency in the subdivision prior to construction. The Project will be served conveniently by current and future commercial at nearby Copper Avenue.

The project will require that each property owner proposed, the greatest ability possible, for their developed to be planned and coordinated with the physical or visual access to open space and other community amenities in mind. All of the lots have a minimum square footage of 87,120 square feet unless otherwise indicated on the approved tract map. Where lots deviate from the minimum square footage it shall not be less than 10% below the area standard.

The following residential design guidelines will reinforce the traditional neighborhood qualities and the resident's ability to visually enjoy surrounding vistas and open space amenities.

### **8. Residential Design Guidelines**

The Project will may have:

- a) An emphasis should be given to creating residences with strong indoor/outdoor relationships through the generous use of windows, doors, and appropriate landscaping.
- b) Setbacks may vary for maximum flexibility with the goal of creating a comfortable street edge for pedestrians.
- c) Building elevations and mass should be articulated to avoid monotony of a single architectural theme yet avoids mixing significantly different architectural styles. Each individual owner shall be required to submit a architectural building theme package to the HOA for approval prior to starting construction.
- d) The visual impact of garages shall be reduced by a variety of means, including, but not limited to, garages which are set back from non-garage façade or porch, units with forward garages which also include courtyards, arbors, arches, or other similar treatments to enhance the streetscape, or side-turned garages.
- e) Exterior wall materials should reflect the character of the region. Stone accents are encouraged along the building base and columns.<sup>3</sup>
- f) The use of lighter, subdued colors as the body color and brighter accent colors to accentuate architectural details are encouraged.
- g) Roofing material shall consist of concrete or clay tile and of a natural color depending on the medium. Where medium to dark gray colors and style are used they shall be selected to match the overall architectural theme of the home.
- h) Mechanical equipment (e.g., compressors, air conditioners, antennas, heat pumps, solar collectors, and satellite dishes) should not be visible to the public.<sup>4</sup>

## 9. Residential Development Standards

Since the Planned Unit Development process is not available in the RR Zoning District, Variance requests will be made for the Elegante Estates Project, in order to provide for an orderly development, taking into account existing terrain, trees, and other natural features.

---

<sup>3</sup> This paragraph relates to Question #10 of the Operational Checklist provided by the County of Fresno

<sup>4</sup> This paragraph relates to Question #9 of the Operational Checklist provided by the County of Fresno

Set out below is the request for Variance and Exceptions to Standards.

**10. Variance Requests for Tract \_\_\_\_\_:**

- a) Road Frontage.
- b) Private gated community.

**11. Landscaping and Neighborhood Entries**

Plant materials are a strong unifying element and should reflect the physical, functional, and aesthetic qualities of the site and architectural elements. Limited palettes of material in simple compositions are recommended to achieve the overall semi-rural theme. Areas which will be landscaped, by Elegante Estates, include the two entry points to the Project from Willow Avenue on the east and the emergency entry to the west on Friant Road; accent or pocket landscape areas may be incorporated at specific locations of the internal local neighborhood streets, cul-de-sacs leading to open space corridors, neighborhood entries; such locations will be determined by Elegante Estates HOA.<sup>5</sup>

**12. Friant Road and Willow Avenue**

Friant Road and Willow Avenue represent important edges for project identification and character due to the visibility of portions of the Project site from this roadway. Generally landscape will be focused and installed at select locations, where existing or proposed terrains support such installations, but which are generally to be focused an entry points or segments near entries.

The landscape plantings will be in character with the overall semi-rural theme of the area and relate strongly with the neighborhood entry treatments.<sup>6</sup>

All landscaped areas will be drought tolerant to sustain normal growth and capable of being maintained in good repair for long periods.<sup>7</sup>

All front yards and back yards and a buffer zone for fire protection on each lot, and other open space areas will be irrigated with the respective lot owners's individual well.

---

<sup>5</sup> This paragraph relates to Question #18 of the Operational Checklist provided by the County of Fresno

<sup>6</sup> This paragraph relates to Question #18 of the Operational Checklist provided by the County of Fresno

<sup>7</sup> This paragraph relates to Question #18 of the Operational Checklist provided by the County of Fresno

### **13. Neighborhood Entries**

Neighborhood entry treatments will be located on the easterly side of the entry point from Willow Avenue. In keeping with the semi-rural theme like the neighboring communities, signage will be built upon low-key neighborhood entry treatments that will be easily identifiable to vehicular traffic. Natural materials such as stone or boulder monoliths with signage plaques mounted or carved onto the surface will be used to identify neighborhood entries.

### **14. Local Street Trees**

Street trees play an important role in the quality of the local neighborhood environment. Lot specific property owners will be required to properly plant trees of the correct species that will grow into a shade canopy over local streets. The use of canopy trees saves energy by cooling the area and increases property values by improving the neighborhood streetscape aesthetics.<sup>8</sup>

### **15. Fencing**

A coordinated system of fencing styles, to be installed by each specific lot owner, has been established that responds to a variety of fencing conditions related to aesthetics, privacy, and the overall semi-rural theme of the adjacent neighborhoods. The fencing types established specify the type of fencing that is to be utilized within and along the perimeter of Project site.<sup>9</sup>

The following standards are intended to ensure the coordination, quality, and proper design of all fencing materials within the development area. Unless otherwise specified, the following standards shall govern in addition to the fencing requirements of Section 80-4 of the Fresno County Standard Specifications. HOA CC&R's which will contain detail as to walls, fences, and gates will be developed for the Tract for enforcement by the Owners Association. Set out below is an overview as it relates to fencing<sup>10</sup>:

a) Individual lots for security purposes may include fencing around the housing unit, however, the following types are prohibited: solid wood board, chain link, barbed wire, and other similar fencing materials.

b) Where lot fencing is installed it shall be installed by the lot owner, unless associated with a Elegante Estates HOA maintained area,.

---

<sup>8</sup> This paragraph relates to Question #18 of the Operational Checklist provided by the County of Fresno

<sup>9</sup> This paragraph relates to Question #18 of the Operational Checklist provided by the County of Fresno

<sup>10</sup> This paragraph relates to Question #18 of the Operational Checklist provided by the County of Fresno

c) Property owners, at a minimum, shall be required to install a perimeter fencing (consistent with the standard herein) at the time of housing construction where such lots are located on the perimeter of the project limits. Where such perimeter fencing is associated with a HOA maintained facility, it shall be installed by Elegante Estates HOA.<sup>11</sup>

## **16. Lighting**

Simple efficient street lighting mounted on standard poles may be provided at Elegante Estates HOA maintained areas, such as entry points to Willow and Friant Road and select common areas. Street lighting, where installed, will be spaced to provide safety to motorists and pedestrians while retaining the overall semi-rural theme of the adjacent neighborhoods. Lot owner installed architectural lighting effects are encouraged at lot entries or integrated with landscaping to promote nighttime identity and character. Excessive lighting and glare should be minimized through careful selection and placement of lighting standards and illumination levels.<sup>12</sup>

a) Street lighting shall be consistent with the development standards as adopted by the Elegante Estates HOA. All lighting which is installed within or adjacent to roadways, private or HOA, shall be similar or identical per the development standards and as approved by the HOA prior to installation.<sup>13</sup>

b) Lighting fixtures should direct light downward and minimize area glare and light spillover.<sup>14</sup>

## **17. Circulation**

### **Willow Avenue**

Winchell Cove Road serves as the primary circulation route to the Tract.

### **Local Streets**

Local streets will be private, providing access and circulation to individual lots. The street sections are shown on Tract.

If required, the developer may enter into a traffic improvement agreement with the

---

<sup>11</sup> This paragraph relates to Question #18 of the Operational Checklist provided by the County of Fresno

<sup>12</sup> This paragraph relates to Question #17 of the Operational Checklist provided by the County of Fresno

<sup>13</sup> This paragraph relates to Question #17 of the Operational Checklist provided by the County of Fresno

<sup>14</sup> This paragraph relates to Question #17 of the Operational Checklist provided by the County of Fresno



County to provide for the funding of the required traffic and transportation improvements. The Agreement will be executed prior to the approval of a Final Subdivision Map.

## **18. Grading**

The Elegante Estates Project respects the physical character and environmental area and is sensitive to visual qualities, building types, and development efficiency.

The Project will be designed, and will implement through HOA development guidelines, grading and drainage standards that will (to the extent feasible) be compatible with the physical character and environmental qualities of the area to the north and south and the topography that separate the development area from developments surrounding it.

The following general standards apply to the grading within the Project site, subsequent HOA development standards may supersede the information below are supplement the intent and design criteria intentions of the subdivision. The intent of these standards is to establish a balance in the overall approach to site development and the visual qualities of the prominent ridgeline and the site's "rolling" terrain.

### **Mass Grading Standards**

- a) Mass graded sites should be contoured and shaped to resemble, to the extent feasible, the natural topographic forms. It is intended by some grading will be enacted by the Elegante Estates project with secondary grading occurring by each respective lot owner at the time of housing construction.
- b) Pads shall drain to a public street or Storm Drainage System where feasible and consistent with the overall drainage guidelines and requirements of the HOA development standards and Fresno Metropolitan Flood Control District.
- c) The maximum vertical height of retaining walls between pads or benches may be no more than five vertical feet as measured from the base of wall to top of wall Where additional retaining height is required walls shall be tiered with offsets not less than 10 horizontal feet between walls. The criteria above does not indicate that such standards are applicable to all construction, each lot owner shall be required to obtain the recommendations of qualified geotechnical consultant for verification of all construction.
- d) All retaining walls to create building pads shall be constructed of

reinforced materials.

e) The exposed face of a foundation stem wall shall not exceed five feet in average height and shall be landscaped and/or screened with surfacing materials to disguise typical foundation building materials (concrete, etc)

f) Stockpile and borrow sites may be permitted within an area that is scheduled for future development. Such stockpiles must be knocked down to provide for suitable access for fire management of regular discing or mowing. Stockpiles shall not divert drainage to unauthorized discharge points.

### **Hillside Grading Standards**

a) Toe and crest of manufactured slopes should be rounded to blend with adjoining terrain to the extent feasible. Generally slopes shall not exceed 3:1.

b) Where graded slopes intersect, the ends of each slope should be horizontally rounded and blended.

c) All grading should be phased so that prompt revegetation or construction of improvements will control erosion. Temporary erosion control methods will be utilized where permanent installation is infeasible.

d)

## **19. Infrastructure**

All permanent utilities in the subdivision will be underground. Temporary overhead facilities will be allowed during the construction phases of the Project.

All potable water to serve each lot will be served with ground water to be delivered through individual wells within the Project area and maintained by the individual lot owners.<sup>15</sup>

Elegante Estates preliminarily identifies the following Developer infrastructure obligations:

---

<sup>15</sup> This paragraph relates to Question #13 of the Operational Checklist provided by the County of Fresno

- a) Construction of on-site improvements, road ways, entry features.
- b) Right-of-way dedication and construction of improvements as applicable on major street frontages.
- c) If required, extension of facilities from the proposed Project to the nearest improved point of connection if existing facilities are not adequate to serve the Project. This includes right-of-way dedication for streets, water and sewer lines, and construction of these facilities. Temporary facilities may be installed to serve the Project at the cost of the Project developer.
- d) At specific locations, dedication and improvement of drain ways, trail system and open space where applicable. Additional drainage ways and channels, with respect to or within some lots, may be constructed by individual property owners.
- e) Dedication of right-of-way for outside travel lanes and intersection improvements where applicable.
- f)

**20. Number of Employees:**

As a residential development no permanent employees will be staff on site. The HOA will implement the use of landscaping maintenance which will be part-time.<sup>16</sup>

**21. Service and Delivery Vehicles:**

Third-party service facilities (vehicles, equipment, etc) for the general maintenance private residences and HOA common areas shall typically operate only during regular business hours.<sup>17</sup>

Service to the common landscape areas includes delivery of special fertilizers and maintenance supplies. It is projected that minimal trips per month will be necessary for supplies and materials.<sup>18</sup>

**22. Number of Parking Spaces for Employees, Customers, and Service/Delivery Vehicles: Type of Surface on Parking Area:**

---

<sup>16</sup> This paragraph relates to Question #4 of the Operational Checklist provided by the County of Fresno

<sup>17</sup> This paragraph relates to Question #5 of the Operational Checklist provided by the County of Fresno

<sup>18</sup> This paragraph relates to Question #5 of the Operational Checklist provided by the County of Fresno

Parking spaces are generally not provided, either on street or at the residential lots, but where such areas accommodate parking within the street it shall be limited to less than 24 hours of time. Overnight on-street parking will not be allowed unless specifically approved by the HOA.<sup>19</sup>

**23. Water and Energy Conservation and Fire Protection:**

a) Water Conservation:

(1) Each lot is divided into two zones. Zone A, a buffer zone around the dwelling unit and yard to serve as an area to maintain a natural terrain and topography as well as protect the dwelling unit from grass fire, and Zone B or Yard Area is the area immediately surrounding the home providing for a more traditional residential landscaping but within a reasonably sized defined area.

Yard Area - Zone B: Approximately 20,000 to 35,000 square feet per yard.

Natural Terrain - Zone A: Approximately 60,000 to 45,000 square feet per yard.

All HOA areas and lots shall include the use of time-controlled irrigation facilities and metered devices.

(2) HOA maintained landscape irrigation will be reduced during daylight hours in the months of May through October. This measure will reduce loss due to evapotranspiration. Property owners shall be required to follow the water schedules. Where excess watering or irrigation run-off occurs property owners shall be required to repair such occurrences.

(3) Yard landscape for each unit shall be designed by the homeowner using architectural guidelines. Each landscape plan shall be approved by the Project based on an overall landscape approach of appropriate vegetation and square footage of area understanding the limitation of water available for yard landscape irrigation. Well water shall be applied by water efficient means and methods between the hours of 9 P.M. and 6 A.M.<sup>20</sup>

b) Energy Conservation:

---

<sup>19</sup> This paragraph relates to Question #7 of the Operational Checklist provided by the County of Fresno

<sup>20</sup> This paragraph relates to Question #18 of the Operational Checklist provided by the County of Fresno

(1) Building energy consumption shall be reduced through site planning and building development standards.

(2) The lot plans prepared by each property for each individual lot will include optimization of appropriate tree planting to provide shading of paved areas.

(3) Additional measures for energy efficiency and conservation which describes the efforts toward achieving energy efficiency in site planning and building design may be implemented

c) Fire Protection:

(1) Each residential unit in the subdivision \_\_\_\_ will have a requirement for the installation of residential fire sprinklers and the minimum fire water storage (if required) in accordance with CalFire standards. Such facilities shall be the obligation of each property owner at the time of construction.

(2) As required by the Fresno Cal Fire, private lot owner water lines and fire hydrants (draft or pressurized) may be provided adjacent to structures.

**24. Landscape Plan:**

The Elegante Estates Project will be landscaped with drought tolerant plants, which will be irrigated with groundwater.<sup>21</sup>

**25. Sale of Goods on Site:**

Not applicable.<sup>22</sup>

**26. Equipment to be Used:**

Landscaping: Equipment used for mowing and maintaining of turf and irrigation-related equipment.<sup>23</sup>

---

<sup>21</sup> This paragraph relates to Question #18 of the Operational Checklist provided by the County of Fresno

<sup>22</sup> This paragraph relates to Question #8 of the Operational Checklist provided by the County of Fresno

<sup>23</sup> This paragraph relates to Question #9 of the Operational Checklist provided by the County of Fresno

27. **Supplies and Materials:**

Only those minimal supplies required to maintain trail system and common HOA area.<sup>24</sup>

28. **Does the Use Cause an Unsightly Appearance? Noise? Glare? Dust? Odor? If so, Explain How This Will be Reduced or Eliminated:**

The entire project will produce negligible amounts of dust, glare, and odor. Some additional noise will be generated by the normal operation of cars and service vehicles.<sup>25</sup>

29. **List Any Solid or Liquid Wastes to be Produced: Estimated Volume of Wastes: How and Where is it Stored? How is it Hauled and Where is it Disposed? How Often?:**

Not applicable to solid waste.<sup>26</sup>

30. **Estimated Volume of Water to be Used (Gallons Per Day): Source of Water:**

For the purpose of estimation of water usage, population density is anticipated to be 4 person per lot with an estimated per capita water usage of 300 gpd/per person for combined indoor and outdoor irrigation purposes (100 gpd for indoor and 200 gpd for irrigation). Total per day usage is estimated to be approximately 7,200 gpd for indoor usages for the 18-lot Project and 14,400 gpd for irrigation purposes.<sup>27</sup>

31. **Describe Any Proposed Advertising, Including Size, Appearance, and Placement:**

No signage is involved in the project except as required by applicable health or safety standards.<sup>28</sup>

32. **Will Existing Buildings be Used or Will New Buildings be Constructed? Describe Type of Construction Materials, Height, Color, Etc. Provide Floor Plan and Elevations, if Appropriate:**

---

<sup>24</sup> This paragraph relates to Question #10 of the Operational Checklist provided by the County of Fresno

<sup>25</sup> This paragraph relates to Question #11 of the Operational Checklist provided by the County of Fresno

<sup>26</sup> This paragraph relates to Question #12 of the Operational Checklist provided by the County of Fresno

<sup>27</sup> This paragraph relates to Question #13 of the Operational Checklist provided by the County of Fresno

<sup>28</sup> This paragraph relates to Question #14 of the Operational Checklist provided by the County of Fresno

New residences will be constructed consistent with the standards described in this operational statement.<sup>29</sup>

33. **Will Any Outdoor Lighting or an Outdoor Sound Amplification System be Used? Describe and Indicate When Used:**

Landscaping lighting and street lighting as described in the operational statement.<sup>30</sup>

34. **Landscaping or Fencing Proposed? Describe Type and Location:**

Fencing requirements will be in accordance with the Operational Statement.<sup>31</sup>

B. ADDITIONAL INFORMATION REGARDING WATER USE FOR IRRIGATION AND FIRE FLOWS:

YARD LANDSCAPE.

IRRIGATION OF THE LOT.

IRRIGATION AREAS.

---

<sup>29</sup> This paragraph relates to Question #15 & #16 of the Operational Checklist provided by the County of Fresno

<sup>30</sup> This paragraph relates to Question #17 of the Operational Checklist provided by the County of Fresno

<sup>31</sup> This paragraph relates to Question #18 of the Operational Checklist provided by the County of Fresno



VARIANCE REQUEST AND FINDINGS for Elegante Estates

VARIANCE REQUEST NO. 1:

Variance Request No. 1 -

REQUIRED FINDINGS NECESSARY FOR THE GRANTING OF A  
VARIANCE

GPA 566  
AA 3850  
TTM 6420  
VA 4140

**1. There are exceptional or extraordinary circumstances or conditions applicable to the property involved which do not apply generally to other property in the vicinity having the identical zoning classification.**

Tract 6420 is unique in that it is located on a broad steeped face; this cliff is locally known as the San Joaquin River bluff. Because of the need to address the unique topography and meet slope requirements, the streets in this Project can only be located in certain specific areas and within certain alignments. Placement of the streets to meet these requirements will require adjustments to those usable areas to meet the required configurations. Also, the terrain and granite outcroppings of the site, modification of road frontage is needed for adequate access and usability of the site. Furthermore, this AE-20 Zoning District is surrounded by numerous projects that have produced similar road frontage as this single-family project proposes.

**2. Such Variance is necessary for the preservation and enjoyment of a substantial property right of the Applicant, which right is possessed by other property owners under like conditions in the vicinity having the identical zoning classification.**

Tract 6420 is unique in that it is located on a broad steeped face; this cliff is locally known as the San Joaquin River bluff. Because of the need to address the unique topography and meet slope requirements, the streets for this Project can only be placed in certain specific areas and within certain alignments. Placement of the streets to meet these requirements will require adjustments to frontage standards so usable areas can meet the required configurations. Also, the terrain and granite outcroppings of the site, modification of road frontage is needed for adequate access and usability of the site. Furthermore, this AE-20 Zoning District is surrounded by numerous projects that have produced similar road frontage as this single-family project proposes. Individual lot owners will have adequate vehicular access to residential lots through private roadways.

**3. The granting of a Variance will not be materially detrimental to the public welfare or injurious to property and improvements in the vicinity in which the property is located.**

There are no known detrimental or injurious impacts on adjacent property in granting this Variance. In fact, the proposed project will allow for improvements to drainage and access to benefit property in the vicinity similar to what has been approved and constructed by property in the vicinity. Individual lot owners will have adequate vehicular access to residential lots through private roadways.

**4. The granting of such Variance will not be contrary to the objectives of the General Plan.**

The granting of this Variance would appear to carry out the objectives of the General Plan and allow for additional residential development as required by the State of California housing element and such development would not impact highly productive agricultural lands. Due to the unique headland of the property including its rocky topography, soils and terrain it is not suitable for commercial agricultural especially given the input of the neighboring residential development and concerns with commercial agricultural operations. Furthermore a economical cattle grazing operation is not sustainable.

**The proposed parcels are not participating in the Williamson Act.**

We are requesting that the two subject properties be re-designated as Rural Residential zoning district within the Fresno County General Plan. The Rural Residential policies state that the minimum net lot size for a parcel shall be two acres.

The rural residential policies of the General Plan do not specifically address requirements for public road frontage. According to the Transportation Element of the General Plan, the primary function of these local roads is to provide subdivision residents access to homes. The subject parcels are not enrolled in the Williamson Act Program.



**Legend**

-  12760 N Friant Rd
-  Feature 1
-  Feature 2
-  Gypsy Jane's Painted house
-  Specialty Products
-  Trinity Community Church





## Elegante Estates Project

Air Quality & Greenhouse Gas Impact  
Assessment April 2022 (GPA 566; AA 3850; TTM  
6420; VA 4140)

**Prepared by:**

VRPA Technologies, Inc.  
4630 W. Jennifer, Suite 105  
Fresno, CA 93722  
Project Manager: Georgiena Vivian



# Table of Contents

Section	Description	Page
<b>1.0</b>	<b>Introduction</b>	<b>1</b>
1.1	Description of the Region/Project	1
1.2	Regulatory	1
1.2.1	Federal Agencies	1
1.2.2	Federal Regulations	5
1.2.3	State Agencies	6
1.2.4	State Regulations	11
1.2.5	Regional Agencies	14
1.2.6	Regional Regulations	15
1.2.7	Local Plans	17
<b>2.0</b>	<b>Environmental Setting</b>	<b>18</b>
2.1	Geographical Conditions	18
2.2	Topographic Conditions	18
2.3	Climate Conditions	18
2.4	Anthropogenic (Man Made) Sources	20
2.4.1	Motor Vehicles	21
2.4.2	Agricultural and Other Miscellaneous Activities	22
2.4.3	Industrial Plants	22
2.5	San Joaquin Valley Air Basin Monitoring	22
2.6	Air Quality Standards	25
2.6.1	Ozone (1-hour and 8-hour)	25
2.6.2	Suspended PM (PM10 and PM2.5)	27
2.6.3	Carbon Monoxide (CO)	28
2.6.4	Nitrogen Dioxide (NO2)	29
2.6.5	Sulfur Dioxide (SO2)	30
2.6.6	Lead (Pb)	31
2.6.7	Toxic Air Contaminants (TAC)	31
2.6.8	Odors	34
2.6.9	Naturally Occurring Asbestos (NOA)	35
2.6.10	Greenhouse Gas Emissions	35
<b>3.0</b>	<b>Air Quality Impacts</b>	<b>37</b>
3.1	Methodology	37
3.1.1	CalEEMod	37

---

3.2	Short-Term Impacts	38
3.3	Long Term Emissions	39
3.3.1	Localized Operational Emissions Ozone/Particulate Matter	39
3.3.2	Localized Operational Emissions	39

## 4.0 Impact Determinations and Recommended Mitigation 50

4.1	Air Quality	50
4.1.1	Conflict with or obstruct implementation of the applicable air quality plan	51
4.1.2	Result in a cumulatively considerable net increase of any criteria pollutant for which the project region is non-attainment under an applicable federal or state ambient air quality standard	51
4.1.3	Expose sensitive receptors to substantial pollutant concentrations	51
4.1.4	Result in other emissions such as those leading to odors adversely affecting a substantial number of people	52
4.2	Greenhouse Gas Emissions	53
4.2.1	Generate greenhouse gas emissions, either directly or indirectly, that may have a significant impact on the environment	53
4.2.2	Conflict with an applicable plan, policy or regulation adopted for the purpose of reducing the emissions of greenhouse gases	53

## Appendices

Appendix A – CalEEMod Worksheets

## List of Tables

1	Ambient Air Quality Standards	9
2	Maximum Pollutant Levels at Madera’s Avenue 14 and Pump Yard Monitoring Station	23
3	Madera County Attainment Status	24
4	Recommendations on Siting New Sensitive Land Uses Such As Residences, Schools, Daycare Centers, Playgrounds, or Medical Facilities	33
5	Screening Levels for Potential Odor Sources	35

---

6	Air Quality Thresholds of Significance	37
7	Project Construction Emissions (tons/year)	39
8	Project Operational Emissions (tons/year)	39
9	Project Operational Greenhouse Gas Emissions in CO <sub>2</sub> e	49

## List of Figures

1	Regional Location	3
2	Project Location	4
3	San Joaquin Valley Air Basin	8

---



## 1.0 Introduction

### 1.1 Description of the Region/Project

The Project Applicant is proposing to develop a residential tract consisting of 18 single-family homes and associated improvements on APNs 579-060-37 and 579-060-55 in unincorporated Fresno County, CA.

This Air Quality & Greenhouse Gas Impact Assessment has been prepared for the purpose of identifying potential project-specific or site-specific air quality impacts that may result from the Project. Figures 1 and 2 show the location of the Project along with major roadways and highways.

Fresno County is located in one of the most polluted air basins in the country – the San Joaquin Valley Air Basin (SJVAB). The surrounding topography includes foothills and mountains to the east and west. These mountain ranges direct air circulation and dispersion patterns. Temperature inversions can trap air within the Valley, thereby preventing the vertical dispersal of air pollutants. In addition to topographic conditions, the local climate can also contribute to air quality problems. Climate in the County is characterized by hot, dry summers and cool winters with the notable presence of Tule fog.

### 1.2 Regulatory

Air quality within the Project area is addressed through the efforts of various federal, state, regional, and local government agencies. These agencies work jointly, as well as individually, to improve air quality through legislation, regulations, planning, policymaking, education, and a variety of programs. The agencies primarily responsible for improving the air quality within Fresno County are discussed below along with their individual responsibilities.

#### 1.2.1 Federal Agencies

##### ✓ U.S. Environmental Protection Agency (EPA)

The Federal Clean Air Bill first adopted in 1967 and periodically amended since then, established federal ambient air quality standards. A 1987 amendment to the Bill set a deadline for the attainment of these standards. That deadline has since passed. The other Clean Air Act (CAA) Bill Amendments, passed in 1990, share responsibility with the State in reducing emissions from mobile sources. The U.S. Environmental Protection Agency (EPA) is responsible for enforcing the 1990 amendments.

The CAA and the national ambient air quality standards identify levels of air quality for six “criteria” pollutants, which are considered the maximum levels of ambient air pollutants considered safe, with an adequate margin of safety, to protect public health and welfare. The six criteria pollutants include ozone, carbon monoxide (CO), nitrogen dioxide, sulfur dioxide, particulate matter, and lead.

CAA Section 176(c) (42 U.S.C. 7506(c)) and EPA transportation conformity regulations (40 CFR 93 Subpart A) require that each new RTP and Transportation Improvement Program (TIP) be demonstrated to conform to the State Implementation Plan (SIP) before the RTP and TIP are approved by the Metropolitan planning organization (MPO) or accepted by the U.S. Department of Transportation (DOT). The conformity analysis is a federal requirement designed to demonstrate compliance with the National Ambient Air Quality Standards (NAAQS). However, because the State Implementation Plan (SIP) for particulate matter 10 microns or less in diameter (PM10), particulate matter 2.5 microns or less in diameter (PM2.5), and Ozone address attainment of both the State and federal standards, for these pollutants, demonstrating conformity to the federal standards is also an indication of progress toward attainment of the State standards. Compliance with the State air quality standards is provided on the pages following this federal conformity discussion.

### Elegante Estates Project Regional Location

Figure  
1

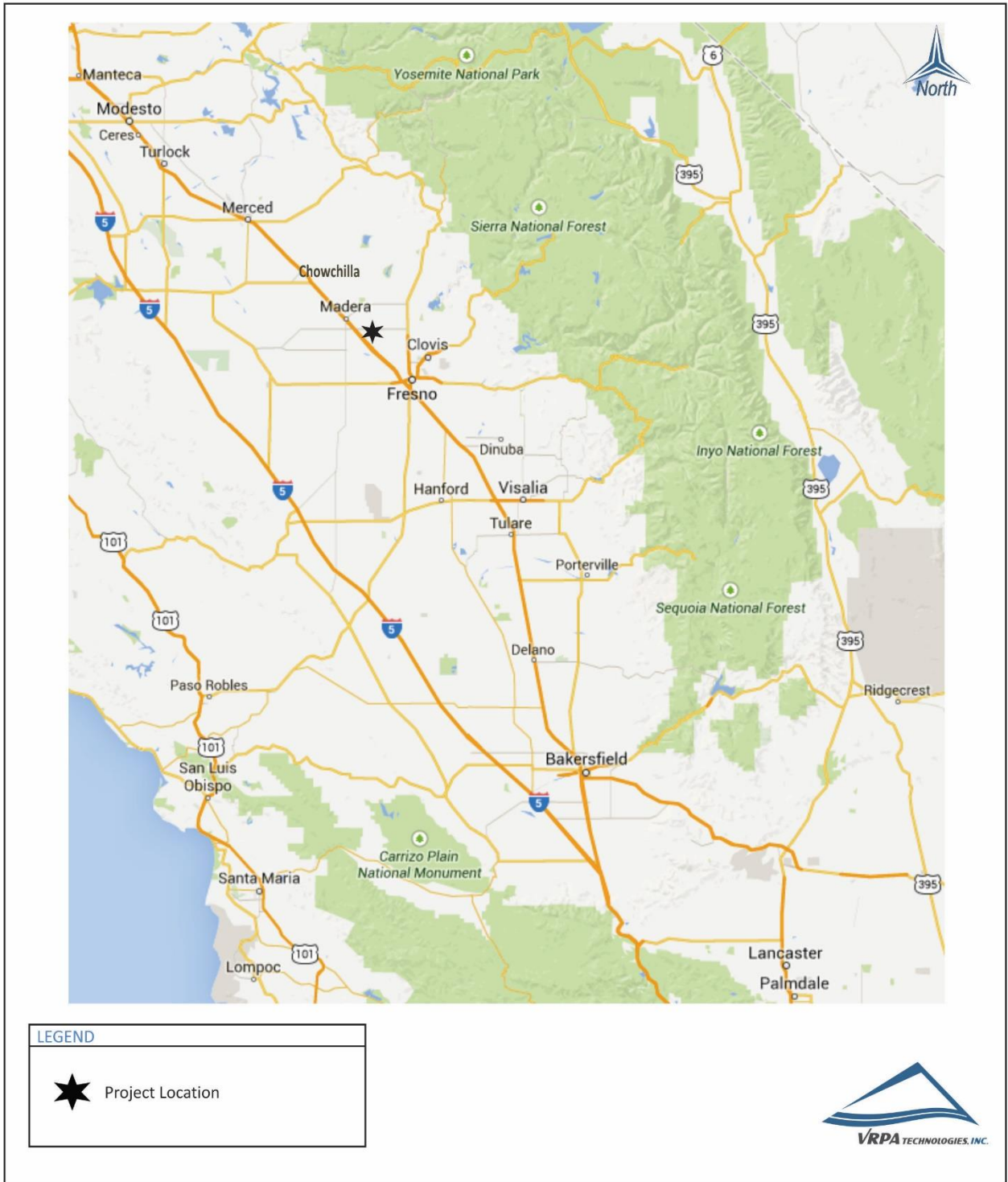

**Elegante Estates Project  
Project Location**

**Figure  
2**

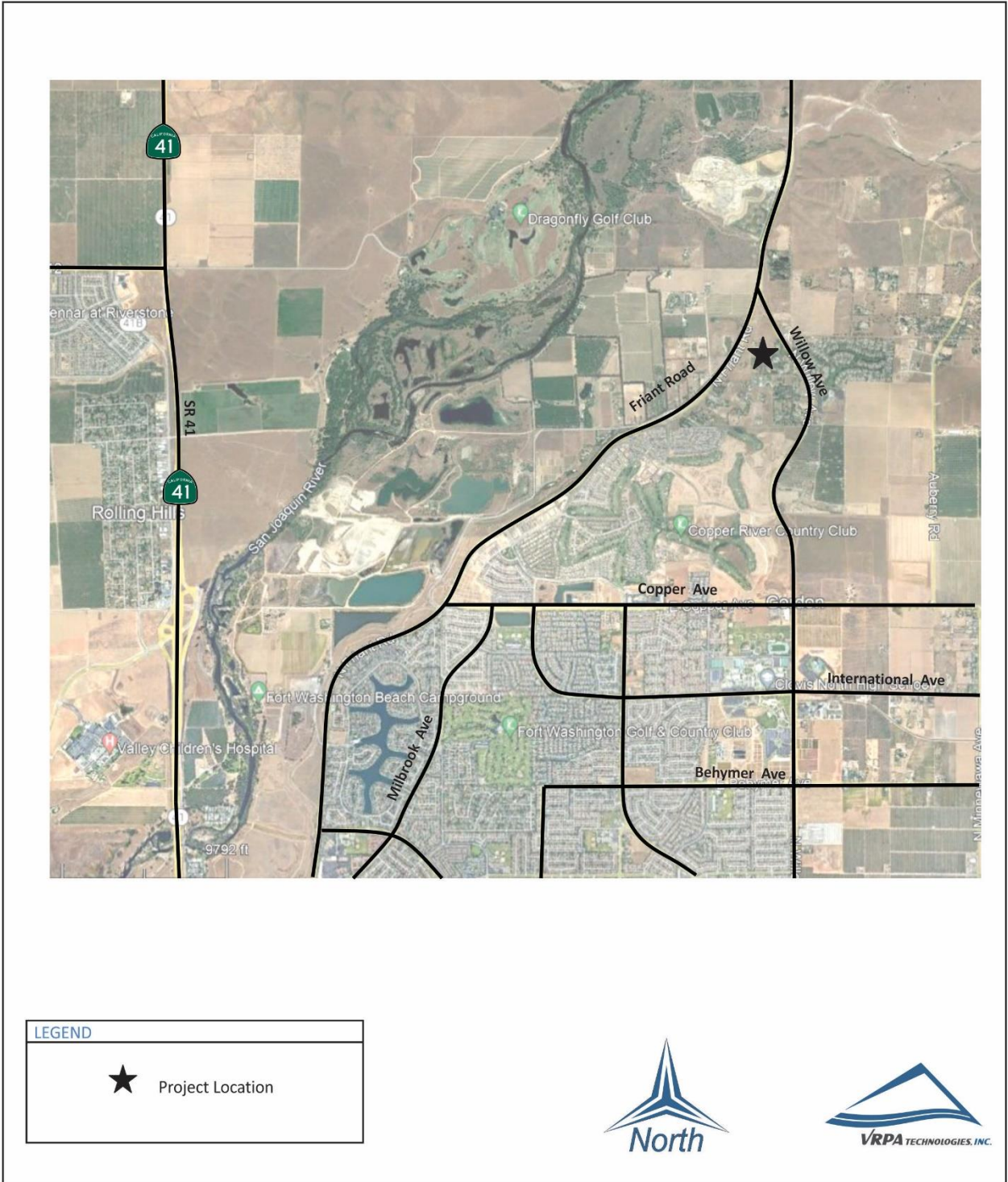



The EPA approved San Joaquin Valley reclassification of the ozone (8-hour) designation to extreme nonattainment in the Federal Register on May 5, 2010, even though the San Joaquin Valley was initially classified as serious nonattainment for the 1997 8-hour ozone standard. In accordance with the CAA, EPA uses the design value at the time of standard promulgation to assign nonattainment areas to one of several classes that reflect the severity of the nonattainment problem; classifications range from marginal nonattainment to extreme nonattainment. In the Federal Register on October 26, 2015, the EPA revised the primary and secondary standard to 0.070 parts per million (ppm) to provide increased public health protection against health effects associated with long- and short-term exposures. The previous ozone standard was set in 2010 at 0.075 ppm.

### 1.2.2 Federal Regulations

#### ✓ State Implementation Plan (SIP)/ Air Quality Management Plans (AQMPs)

To ensure compliance with the NAAQS, EPA requires states to adopt SIP aimed at improving air quality in areas of nonattainment or a Maintenance Plan aimed at maintaining air quality in areas that have attained a given standard. New and previously submitted plans, programs, district rules, state regulations, and federal controls are included in the SIPs. Amendments made in 1990 to the federal CAA established deadlines for attainment based on an area's current air pollution levels. States must enact additional regulatory programs for nonattainment's areas in order to adhere with the CAA Section 172. In California, the SIPs must adhere to both the NAAQS and the California Ambient Air Quality Standards (CAAQS).

To ensure that State and federal air quality regulations are being met, Air Quality Management Plans (AQMPs) are required. AQMPs present scientific information and use analytical tools to identify a pathway towards attainment of NAAQS and CAAQS. The San Joaquin Valley Air Pollution Control District (SJVAPCD) develops the AQMPs for the region where the Fresno Council of Governments (FCOG) operates. The regional air districts begin the SIP process by submitting their AQMPs to the California Air Resources Board (CARB). CARB is responsible for revising the SIP and submitting it to EPA for approval. EPA then acts on the SIP in the Federal Register. The items included in the California SIP are listed in the Code of Federal Regulations Title 40, Chapter 1, Part 52, Subpart 7, Section 52.220.

#### ✓ Transportation Control Measures

One particular aspect of the SIP development process is the assessment of available transportation control measures (TCMs) as a part of making progress towards clean air goals. TCMs are defined in Section 108(f)(1) of the CAA and are strategies designed to reduce vehicle miles traveled, vehicle idling, and associated air pollution. These goals are generally achieved by developing attractive and convenient alternatives to single-occupant vehicle use. Examples of TCMs include ridesharing programs, transportation infrastructure improvements such as adding bicycle and carpool lanes, and expansion of public transit.

### ✓ **Energy Policy Act of 1992 (EPAAct)**

The Energy Policy Act of 1992 (EPAAct) was passed to reduce the country's dependence on foreign petroleum and improve air quality. EPAAct includes several parts intended to build an inventory of alternative fuel vehicles (AFVs) in large, centrally fueled fleets in metropolitan areas. EPAAct requires certain federal, state, and local government and private fleets to purchase a percentage of light duty AFVs capable of running on alternative fuels each year. In addition, financial incentives are included in EPAAct. Federal tax deductions will be allowed for businesses and individuals to cover the incremental cost of alternative fueled vehicles (AFVs). States are also required by the act to consider a variety of incentive programs to help promote AFVs.

### 1.2.3 *State Agencies*

#### ✓ **California Air Resources Board (CARB)**

CARB is the agency responsible for coordination and oversight of State and local air pollution control programs in California and for implementing its own air quality legislation called the California Clean Air Act (CCAA), adopted in 1988. CARB was created in 1967 from the merging of the California Motor Vehicle Pollution Control Board and the Bureau of Air Sanitation and its Laboratory.

CARB has primary responsibility in California to develop and implement air pollution control plans designed to achieve and maintain the NAAQS established by the EPA. Whereas CARB has primary responsibility and produces a major part of the SIP for pollution sources that are statewide in scope, it relies on the local air districts to provide additional strategies for sources under their jurisdiction. CARB combines its data with all local district data and submits the completed SIP to the EPA. The SIP consists of the emissions standards for vehicular sources and consumer products set by CARB, and attainment plans adopted by the Air Pollution Control Districts (APCDs) and Air Quality Management District's (AQMDs) and approved by CARB.

States may establish their own standards, provided the State standards are at least as stringent as the NAAQS. California has established California Ambient Air Quality Standards (CAAQS) pursuant to California Health and Safety Code (CH&SC) [§39606(b)] and its predecessor statutes.

The CH&SC [§39608] requires CARB to "identify" and "classify" each air basin in the State on a pollutant-by-pollutant basis. Subsequently, CARB designated areas in California as nonattainment based on violations of the CAAQSS. Designations and classifications specific to the SJVAB can be found in the next section of this document. Areas in the State were also classified based on severity of air pollution problems. For each nonattainment class, the CCAA specifies air quality management strategies that must be adopted. For all nonattainment categories, attainment plans are required to demonstrate a five percent-per-

year reduction in nonattainment air pollutants or their precursors, averaged every consecutive three-year period, unless an approved alternative measure of progress is developed. In addition, air districts in violation of CAAQS are required to prepare an Air Quality Attainment Plan (AQAP) that lays out a program to attain and maintain the CCAA mandates.

CARB, in consultation with MPOs, has provided each affected region with reduction targets for GHGs emitted by passenger cars and light trucks in the region for the years 2020 and 2035. For the Fresno Council of Governments (FCOG) region, CARB set targets at five (5) percent per capita decrease in 2020 and a ten (10) percent per capita decrease in 2035 from a base year of 2005. FCOG's 2018 Regional Transportation Plan/Sustainable Communities Strategy (RTP/SCS), projects that the Fresno County region would achieve the prescribed emissions targets. The 2022 Regional Transportation Plan is currently in public environmental review but has not yet been adopted.

Other CARB duties include monitoring air quality. CARB has established and maintains, in conjunction with local APCDs and AQMDs, a network of sampling stations (called the State and Local Air Monitoring [SLAMS] network), which monitor the present pollutant levels in the ambient air.

Fresno County is in the CARB-designated, SJVAB. A map of the SJVAB is provided in Figure 3. In addition to Fresno County, the SJVAB includes Kern, Kings, Madera, Merced, San Joaquin, Stanislaus, and Tulare Counties. Federal and State standards for criteria pollutants are provided in Table 1.

**Elegante Estates Project**  
**San Joaquin Valley Air Basin**

**Figure**  
**3**

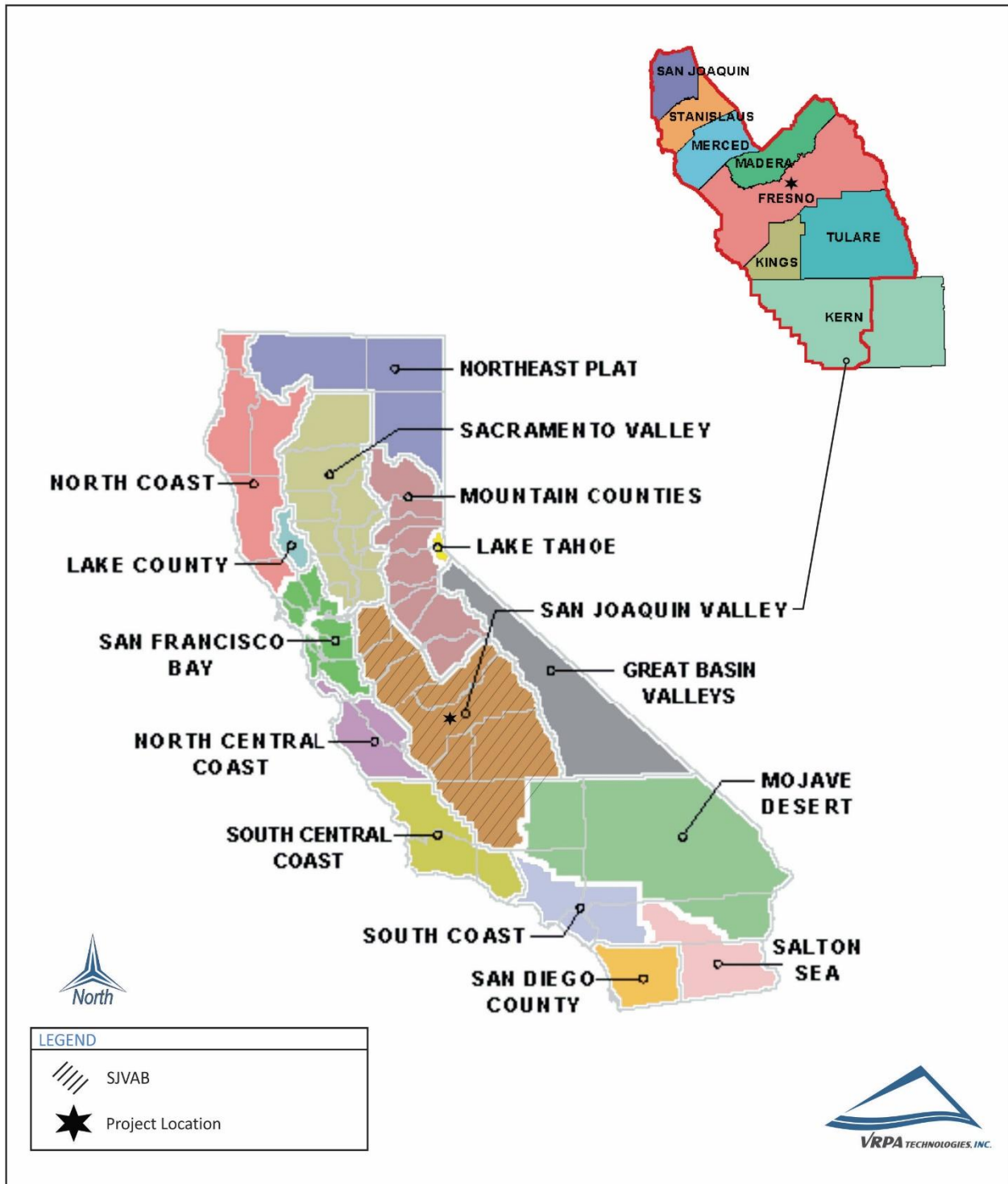



**Table 1**  
**Ambient Air Quality Standards**

Pollutant	Averaging Time	California Standards <sup>1</sup>		National Standards <sup>2</sup>		
		Concentration <sup>3</sup>	Method <sup>4</sup>	Primary <sup>3,5</sup>	Secondary <sup>3,6</sup>	Method <sup>7</sup>
Ozone (O <sub>3</sub> ) <sup>8</sup>	1 Hour	0.09 ppm (180 µg/m <sup>3</sup> )	Ultraviolet Photometry	--	Same as Primary Standard	Ultraviolet Photometry
	8 Hour	0.070 ppm (137 µg/m <sup>3</sup> )		0.070 ppm (137 µg/m <sup>3</sup> )		
Respirable Particulate Matter (PM <sub>10</sub> ) <sup>9</sup>	24 Hour	50 µg/m <sup>3</sup>	Gravimetric or Beta Attenuation	150 µg/m <sup>3</sup>	Same as Primary Standard	Inertial Separation and Gravimetric Analysis
	Annual Arithmetic Mean	20 µg/m <sup>3</sup>		--		
Fine Particulate Matter (PM <sub>2.5</sub> ) <sup>9</sup>	24 Hour	--	--	35 µg/m <sup>3</sup>	Same as Primary Standard	Inertial Separation and Gravimetric Analysis
	Annual Arithmetic Mean	12 µg/m <sup>3</sup>	Gravimetric or Beta Attenuation	12.0 µg/m <sup>3</sup>	15 µg/m <sup>3</sup>	
Carbon Monoxide (CO)	1 Hour	20 ppm (23 mg/m <sup>3</sup> )	Non-Dispersive Infrared Photometry (NDIR)	35 ppm (40 mg/m <sup>3</sup> )	--	Non-Dispersive Infrared Photometry (NDIR)
	8 Hour	9.0 ppm (10 mg/m <sup>3</sup> )		9 ppm (10 mg/m <sup>3</sup> )	--	
	8 Hour (Lake Tahoe)	6 ppm (7 mg/m <sup>3</sup> )		--	--	
Nitrogen Dioxide (NO <sub>2</sub> ) <sup>10</sup>	1 Hour	0.18 ppm (339 µg/m <sup>3</sup> )	Gas Phase Chemiluminescence	100 ppb (188 µg/m <sup>3</sup> )	--	Gas Phase Chemiluminescence
	Annual Arithmetic Mean	0.030 ppm (57 µg/m <sup>3</sup> )		0.053 ppm (100 µg/m <sup>3</sup> )	Same as Primary Standard	
Sulfur Dioxide (SO <sub>2</sub> ) <sup>11</sup>	1 Hour	0.25 ppm (655 µg/m <sup>3</sup> )	Ultraviolet Fluorescence	75 ppb (196 µg/m <sup>3</sup> )	--	Ultraviolet Fluorescence; Spectrophotometry (Pararosaniline Method)
	3 Hour	--		--	0.5 ppm (1300 µg/m <sup>3</sup> )	
	24 Hour	0.04 ppm (105 µg/m <sup>3</sup> )		0.14 ppm (for certain areas) <sup>11</sup>	--	
	Annual Arithmetic Mean	--		0.030 ppm (for certain areas) <sup>11</sup>	--	
Lead <sup>12,13</sup>	30 Day Average	1.5 µg/m <sup>3</sup>	Atomic Absorption	--	--	High Volume Sampler and Atomic Absorption
	Calendar Quarter	--		1.5 µg/m <sup>3</sup> (for certain areas) <sup>11</sup>	Same as Primary Standard	
	Rolling 3-Month Average	--		0.15 µg/m <sup>3</sup>		
Visibility Reducing Particles <sup>14</sup>	8 Hour	See footnote 14	Beta Attenuation and Transmittance through Filter Tape	No National Standards		
Sulfates	24 Hour	25 µg/m <sup>3</sup>	Ion Chromatography			
Hydrogen Sulfide	1 Hour	0.03 ppm (42 µg/m <sup>3</sup> )	Ultraviolet Fluorescence			
Vinyl Chloride <sup>12</sup>	24 Hour	0.01 ppm (26 µg/m <sup>3</sup> )	Gas Chromatography			

See footnotes on next page ...

### Footnotes:

1. California standards for ozone, carbon monoxide (except 8-hour Lake Tahoe), sulfur dioxide (1 and 24 hour), nitrogen dioxide, and particulate matter (PM10, PM2.5, and visibility reducing particles), are values that are not to be exceeded. All others are not to be equaled or exceeded. California ambient air quality standards are listed in the Table of Standards in Section 70200 of Title 17 of the California Code of Regulations.
2. National standards (other than ozone, particulate matter, and those based on annual arithmetic mean) are not to be exceeded more than once a year. The ozone standard is attained when the fourth highest 8-hour concentration measured at each site in a year, averaged over three years, is equal to or less than the standard. For PM10, the 24 hour standard is attained when the expected number of days per calendar year with a 24-hour average concentration above 150 µg/m<sup>3</sup> is equal to or less than one. For PM2.5, the 24 hour standard is attained when 98 percent of the daily concentrations, averaged over three years, are equal to or less than the standard. Contact the U.S. EPA for further clarification and current national policies.
3. Concentration expressed first in units in which it was promulgated. Equivalent units given in parentheses are based upon a reference temperature of 25°C and a reference pressure of 760 torr. Most measurements of air quality are to be corrected to a reference temperature of 25°C and a reference pressure of 760 torr; ppm in this table refers to ppm by volume, or micromoles of pollutant per mole of gas.
4. Any equivalent measurement method which can be shown to the satisfaction of the ARB to give equivalent results at or near the level of the air quality standard may be used.
5. National Primary Standards: The levels of air quality necessary, with an adequate margin of safety to protect the public health.
6. National Secondary Standards: The levels of air quality necessary to protect the public welfare from any known or anticipated adverse effects of a pollutant.
7. Reference method as described by the U.S. EPA. An "equivalent method" of measurement may be used but must have a "consistent relationship to the reference method" and must be approved by the U.S. EPA.
8. On October 1, 2015, the national 8-hour ozone primary and secondary standards were lowered from 0.075 to 0.070 ppm.
9. On December 14, 2012, the national annual PM2.5 primary standard was lowered from 15 µg/m<sup>3</sup> to 12.0 µg/m<sup>3</sup>. The existing national 24-hour PM2.5 standards (primary and secondary) were retained at 35 µg/m<sup>3</sup>, as was the annual secondary standard of 15 µg/m<sup>3</sup>. The existing 24-hour PM10 standards (primary and secondary) of 150 µg/m<sup>3</sup> also were retained. The form of the annual primary and secondary standards is the annual mean, averaged over 3 years.
10. To attain the 1-hour national standard, the 3-year average of the annual 98th percentile of the 1-hour daily maximum concentrations at each site must not exceed 100 ppb. Note that the national 1-hour standard is in units of parts per billion (ppb). California standards are in units of parts per million (ppm). To directly compare the national 1-hour standard to the California standards the units can be converted from ppb to ppm. In this case, the national standard of 100 ppb is identical to 0.100 ppm.
11. On June 2, 2010, a new 1-hour SO<sub>2</sub> standard was established and the existing 24-hour and annual primary standards were revoked. To attain the 1-hour national standard, the 3-year average of the annual 99th percentile of the 1-hour daily maximum concentrations at each site must not exceed 75 ppb. The 1971 SO<sub>2</sub> national standards (24-hour and annual) remain in effect until one year after an area is designated for the 2010 standard, except that in areas designated nonattainment for the 1971 standards, the 1971 standards remain in effect until implementation plans to attain or maintain the 2010 standards are approved.

Note that the 1-hour national standard is in units of parts per billion (ppb). California standards are in units of parts per million (ppm). To directly compare the 1-hour national standard to the California standard the units can be converted to ppm. In this case, the national standard of 75 ppb is identical to 0.075 ppm.

12. The ARB has identified lead and vinyl chloride as 'toxic air contaminants' with no threshold level of exposure for adverse health effects determined. These actions allow for the implementation of control measures at levels below the ambient concentrations specified for these pollutants.
13. The national standard for lead was revised on October 15, 2008 to a rolling 3-month average. The 1978 lead standard (1.5 µg/m<sup>3</sup> as a quarterly average) remains in effect until one year after an area is designated for the 2008 standard, except that in areas designated nonattainment for the 1978 standard, the 1978 standard remains in effect until implementation plans to attain or maintain the 2008 standard are approved.
14. In 1989, the ARB converted both the general statewide 10-mile visibility standard and the Lake Tahoe 30-mile visibility standard to instrumental equivalents, which are "extinction of 0.23 per kilometer" and "extinction of 0.07 per kilometer" for the statewide and Lake Tahoe Air Basin standards, respectively.

### 1.2.4 State Regulations

#### ✓ CARB Mobile-Source Regulation

The State of California is responsible for controlling emissions from the operation of motor vehicles in the State. Rather than mandating the use of specific technology or the reliance on a specific fuel, CARB's motor vehicle standards specify the allowable grams of pollutant per mile driven. In other words, the regulations focus on the reductions needed rather than on the manner in which they are achieved.

#### ✓ California Clean Air Act

The CCAA was first signed into law in 1988. The CCAA provides a comprehensive framework for air quality planning and regulation, and spells out, in statute, the state's air quality goals, planning and regulatory strategies, and performance. The CCAA establishes more stringent ambient air quality standards than those included in the Federal CAA. CARB is the agency responsible for administering the CCAA. CARB established ambient air quality standards pursuant to the CH&SC [§39606(b)], which are similar to the federal standards. The SJVAPCD is one of 35 AQMDs that have prepared air quality management plans to accomplish a five percent (5%) annual reduction in emissions documenting progress toward the State ambient air quality standards.

#### ✓ Tanner Air Toxics Act

California regulates Toxic Air Contaminants (TACs) primarily through the Tanner Air Toxics Act (AB 1807) and the Air Toxics Hot Spots Information and Assessment Act of 1987 (AB 2588). The Tanner Act sets forth a formal procedure for CARB to designate substances as TACs. This includes research, public participation, and scientific peer review before CARB can designate a substance as a TAC. To date, CARB has identified more than 21 TACs and has adopted EPA's list of Hazardous Air Pollutants (HAPs) as TACs. Once a TAC is identified, CARB then adopts an Airborne Toxics Control Measure (ATCM) for sources that emit that particular TAC. If there is a safe threshold for a substance at which there is no toxic effect, the control measure must reduce exposure below that threshold. If there is no safe threshold, the measure must incorporate Best Available Control Technology (BACT) to minimize emissions.

AB 2588 requires that existing facilities that emit toxic substances above a specified level prepare a toxic-emission inventory, prepare a risk assessment if emissions are significant, notify the public of significant risk levels, and prepare and implement risk reduction measures. CARB has adopted diesel exhaust control measures and more stringent emission standards for various on-road mobile sources of emissions, including transit buses and off-road diesel equipment (e.g., tractors, generators).

These rules and standards provide for:

- More stringent emission standards for some new urban bus engines, beginning with 2002 model year engines.
- Zero-emission bus demonstration and purchase requirements applicable to transit agencies
- Reporting requirements under which transit agencies must demonstrate compliance with the urban transit bus fleet rule.

✓ **AB 1493 (Pavley)**

AB 1493 (Pavley) enacted on July 22, 2002, required CARB to develop and adopt regulations that reduce greenhouse gases emitted by passenger vehicles and light duty trucks. Regulations adopted by CARB would apply to 2009 and later model year vehicles. CARB estimated that the regulation would reduce climate change emissions from light duty passenger vehicles by an estimated 18 percent in 2020 and by 27 percent in 2030 [Association of Environmental Professionals (AEP) 2007)]. In 2005, the CARB requested a waiver from U.S. EPA to enforce the regulation, as required under the CAA. Despite the fact that no waiver had ever been denied over a 40-year period, the then Administrator of the EPA sent Governor Schwarzenegger a letter in December 2007, indicating he had denied the waiver. On March 6, 2008, the waiver denial was formally issued in the Federal Register. Governor Schwarzenegger and several other states immediately filed suit against the federal government to reverse that decision. On January 21, 2009, CARB requested that EPA reconsider denial of the waiver. EPA scheduled a re-hearing on March 5, 2009. On June 30, 2009, EPA granted a waiver of CAA preemption to California for its greenhouse gas emission standards for motor vehicles beginning with the 2009 model year.

✓ **Assembly Bill 32 (California Global Warming Solutions Act of 2006)**

California passed the California Global Warming Solutions Act of 2006 (AB 32; California Health and Safety Code Division 25.5, Sections 38500 - 38599). AB 32 establishes regulatory, reporting, and market mechanisms to achieve quantifiable reductions in GHG emissions and establishes a cap on statewide GHG emissions. AB 32 required that statewide GHG emissions be reduced to 1990 levels by 2020. December 31, 2020, is the deadline for achieving the 2020 GHG emissions cap. To effectively implement the cap, AB 32 directs CARB to develop and implement regulations to reduce statewide GHG emissions from stationary sources. AB 32 specifies that regulations adopted in response to AB 1493 should be used to address GHG emissions from vehicles. However, AB 32 also includes language stating that if the AB 1493 regulations cannot be implemented, then CARB should develop new regulations to control vehicle GHG emissions under the authorization of AB 32.

AB 32 requires CARB to adopt a quantified cap on GHG emissions representing 1990 emissions levels and disclose how it arrived at the cap; institute a schedule to meet the emissions cap; and develop tracking, reporting, and enforcement mechanisms to ensure that the state reduces GHG emissions enough to meet the cap. AB 32 also includes guidance on instituting emissions reductions in an economically efficient manner, along with conditions

to ensure that businesses and consumers are not unfairly affected by the reductions. Using these criteria to reduce statewide GHG emissions to 1990 levels by 2020 would represent an approximate 25 to 30 percent reduction in current emissions levels. However, CARB has discretionary authority to seek greater reductions in more significant and growing GHG sectors, such as transportation, as compared to other sectors that are not anticipated to significantly increase emissions.

CARB's 2017 Climate Change Scoping Plan builds on the efforts and plans encompassed in the initial Scoping Plan adopted in December of 2008. The current plan has identified new policies and actions to accomplish the State's 2030 GHG limit.

✓ **Senate Bill 375**

SB 375, signed in September 2008 (Chapter 728, Statutes of 2008), aligns regional transportation planning efforts, regional GHG reduction targets, and land use and housing allocation. SB 375 requires Metropolitan Planning Organizations (MPOs) to adopt a sustainable communities strategy (SCS) or alternative planning strategy (APS) that will prescribe land use allocation in that MPO's regional transportation plan. CARB, in consultation with MPOs, has provided each affected region with reduction targets for GHGs emitted by passenger cars and light trucks in the region for the years 2020 and 2035. For the Fresno Council of Governments (FCOG), CARB set targets at five (5) percent per capita decrease in 2020 and a ten (10) percent per capita decrease in 2035 from a base year of 2005. FCOG 2018 Regional Transportation Plan/Sustainable Communities Strategy (RTP/SCS), which was adopted in August 2018, projects that the Fresno County region would achieve the prescribed emissions targets.

This law also extends the minimum time period for the regional housing needs allocation cycle from five years to eight years for local governments located within an MPO that meets certain requirements. City or county land use policies (including general plans) are not required to be consistent with the regional transportation plan (and associated SCS or APS). However, new provisions of CEQA incentivize (through streamlining and other provisions) qualified projects that are consistent with an approved SCS or APS, categorized as "transit priority projects."

✓ **Executive Order B-30-15**

Executive Order B-30-15, which was signed by Governor Brown in 2016, establishes a California greenhouse gas reduction target of 40 percent below 1990 levels by 2030 to ensure California meets its target of reducing greenhouse gas emissions to 80 percent below 1990 levels by 2050. Executive Order B-30-15 requires MPO's to implement measures that will achieve reductions of greenhouse gas emissions to meet the 2030 and 2050 greenhouse gas emissions reductions targets.

✓ **California Global Warming Solutions Act of 2006: emissions limit, or SB 32**

SB 32 is a California Senate bill expanding upon AB 32 to reduce greenhouse gas (GHG) emissions. The lead author is Senator Fran Pavley and the principal co-author is Assembly member Eduardo Garcia. SB 32 was signed into law on September 8, 2016, by Governor Brown. SB 32 sets into law the mandated reduction target in GHG emissions as written into Executive Order B-30-15. SB 32 requires that there be a reduction in GHG emissions to 40% below the 1990 levels by 2030. Greenhouse gas emissions include carbon dioxide, methane, nitrous oxide, sulfur hexafluoride, hydrofluorocarbons, and perfluorocarbons. The California Air Resources Board (CARB) is responsible for ensuring that California meets this goal. The provisions of SB 32 were added to Section 38566 of the Health and Safety Code subsequent to the bill's approval. The bill went into effect January 1, 2017. SB 32 builds onto Assembly Bill (AB) 32 written by Senator Fran Pavley and Assembly Speaker Fabian Nunez passed into law on September 27, 2006. AB 32 required California to reduce greenhouse gas emissions to 1990 levels by 2020 and SB 32 continues that timeline to reach the targets set in Executive Order B-30-15. SB 32 provides another intermediate target between the 2020 and 2050 targets set in Executive Order S-3-05.

### 1.2.5 Regional Agencies

✓ **San Joaquin Valley Air Pollution Control District**

The SJVAPCD is the agency responsible for monitoring and regulating air pollutant emissions from stationary, area, and indirect sources within Merced County and throughout the SJVAB. The District also has responsibility for monitoring air quality and setting and enforcing limits for source emissions. CARB is the agency with the legal responsibility for regulating mobile source emissions. The District is precluded from such activities under State law.

The District was formed in mid-1991 and prepared and adopted the San Joaquin Valley Air Quality Attainment Plan (AQAP), dated January 30, 1992, in response to the requirements of the State CCAA. The CCAA requires each non-attainment district to reduce pertinent air contaminants by at least five percent (5%) per year until new, more stringent, 1988 State air quality standards are met.

Activities of the SJVAPCD include the preparation of plans for the attainment of ambient air quality standards, adoption and enforcement of rules and regulations concerning sources of air pollution, issuance of permits for stationary sources of air pollution, inspection of stationary sources of air pollution and response to citizen complaints, monitoring of ambient air quality and meteorological conditions, and implementation of programs and regulations required by the FCAA and CCAA.

The SJVAPCD has prepared the following State Implementation Plans to address ozone, PM-10 and PM2.5 that currently apply to non-attainment areas:

- The 2016 Ozone Plan (2008 standard) was adopted by SJVAPCD on June 16, 2016 and

subsequently adopted by ARB on July 21, 2016.

- The 2013 1-Hour Ozone Plan (revoked 1997 standard) was adopted by the SJVAPCD on September 19, 2013. EPA withdrew its approval of the plan due to litigation. The District plans to submit a “redesignation substitute” to EPA to maintain its attainment status for this revoked ozone standard.
- The 2007 PM-10 Maintenance Plan (as revised in 2015) was approved by EPA on July 8, 2016 (effective September 30, 2016).
- The 2012 PM2.5 Plan (as revised in 2015) was approved by EPA on August 16, 2016 (effective September 30, 2016).

The SJVAPCD Plans identified above represent SJVAPCD’s plan to achieve both state and federal air quality standards. The regulations and incentives contained in these documents must be legally enforceable and permanent. These plans break emissions reductions and compliance into different emissions source categories.

The SJVAPCD also prepared the *Guide for Assessing and Mitigation Air Quality Impacts* (GAMAQI), dated March 19, 2015. The GAMAQI is an advisory document that provides Lead Agencies, consultants, and project applicants with analysis guidance and uniform procedures for addressing air quality impacts in environmental documents. Local jurisdictions are not required to utilize the methodology outlined therein. This document describes the criteria that SJVAPCD uses when reviewing and commenting on the adequacy of environmental documents. It recommends thresholds for determining whether or not projects would have significant adverse environmental impacts, identifies methodologies for predicting project emissions and impacts, and identifies measures that can be used to avoid or reduce air quality impacts.

### 1.2.6 Regional Regulations

The SJVAPCD has adopted numerous rules and regulations to implement its air quality plans. Following, are significant rules that will apply to the Project.

#### ✓ Regulation VIII – Fugitive PM10 Prohibitions

Regulation VIII is comprised of District Rules 8011 through 8081, which are designed to reduce PM<sub>10</sub> emissions (predominantly dust/dirt) generated by human activity, including construction and demolition activities, road construction, bulk materials storage, paved and unpaved roads, carryout and track out, landfill operations, etc. The proposed Project will be required to comply with this regulation. Regulation VIII control measures are provided below:

1. *All disturbed areas, including storage piles, which are not being actively utilized for construction purposes, shall be effectively stabilized of dust emissions using water, chemical stabilizer/suppressant, covered with a tarp or other suitable cover or vegetative ground cover.*



2. *All on-site unpaved roads and off-site unpaved access roads shall be effectively stabilized of dust emissions using water or chemical stabilizer/suppressant.*
3. *All land clearing, grubbing, scraping, excavation, land leveling, grading, cut & fill, and demolition activities shall be effectively controlled of fugitive dust emissions utilizing application of water or by presoaking.*
4. *When materials are transported off-site, all material shall be covered, or effectively wetted to limit visible dust emissions, and at least six inches of freeboard space from the top of the container shall be maintained.*
5. *All operations shall limit or expeditiously remove the accumulation of mud or dirt from adjacent public streets at the end of each workday. The use of dry rotary brushes is expressly prohibited except where preceded or accompanied by sufficient wetting to limit the visible dust emissions. Use of blower devices is expressly forbidden.*
6. *Following the addition of materials to, or the removal of materials from, the surface of outdoor storage piles, said piles shall be effectively stabilized of fugitive dust emissions utilizing sufficient water or chemical stabilizer/suppressant.*
7. *Within urban areas, track out shall be immediately removed when it extends 50 or more feet from the site and at the end of each workday.*

✓ **Rule 8021 – Construction, Demolition, Excavation, and Other Earthmoving Activities**

District Rule 8021 requires owners or operators of construction projects to submit a Dust Control Plan to the District if at any time the project involves non-residential developments of five or more acres of disturbed surface area or moving, depositing, or relocating of more than 2,500 cubic yards per day of bulk materials on at least three days of the project. The proposed Project will meet these criteria and will be required to submit a Dust Control Plan to the District in order to comply with this rule.

✓ **Rule 4641 – Cutback, Slow Cure, and Emulsified Asphalt, Paving and Maintenance Operations**

If asphalt paving will be used, then paving operations of the proposed Project will be subject to Rule 4641. This rule applies to the manufacture and use of cutback asphalt, slow cure asphalt and emulsified asphalt for paving and maintenance operations.

✓ **Rule 9510 – Indirect Source Review (ISR)**

The purpose of this rule is to fulfill the District's emission reduction commitments in the PM10 and Ozone Attainment Plans, achieve emission reductions from construction activities, and to provide a mechanism for reducing emissions from the construction of and use of development projects through off-site measures. The rule is expected to reduce nitrogen oxides and particulates throughout the San Joaquin Valley by more than 10 tons per day.



### 1.2.7 Local Plans

#### ✓ County of Fresno General Plan

California State Law requires every city and county to adopt a comprehensive General Plan to guide its future development. The General Plan essentially serves as a “constitution for development”— the document that serves as the foundation for all land use decisions. The County of Fresno General Plan Update (2000) includes various elements, including air quality and greenhouse gases, which address local concerns and provides goals and policies to achieve its development goals.

## 2.0 Environmental Setting

This section describes existing air quality within the San Joaquin Valley Air Basin and in Fresno County, including the identification of air pollutant standards, meteorological and topological conditions affecting air quality, and current air quality conditions. Air quality is described in relation to ambient air quality standards for criteria pollutants such as, ozone, carbon monoxide, and particulate matter. Air quality can be directly affected by the type and density of land use change and population growth in urban and rural areas.

### 2.1 Geographical Location

The SJVAB is comprised of eight counties: Fresno, Kern, Kings, Madera, Merced, San Joaquin, Stanislaus, and Tulare. Encompassing 24,840 square miles, the San Joaquin Valley is the second largest air basin in California. Cumulatively, counties within the Air Basin represent approximately 16 percent of the State's geographic area. The Air Basin is bordered by the Sierra Nevada Mountains on the east (8,000 to 14,492 feet in elevation), the Coastal Range on the west (4,500 feet in elevation), and the Tehachapi Mountains on the south (9,000 feet elevation). The San Joaquin Valley is open to the north extending to the Sacramento Valley Air Basin.

### 2.2 Topographic Conditions

Fresno County is located within the San Joaquin Valley Air Basin [as determined by the California Air Resources Board (CARB)]. Air basins are geographic areas sharing a common "air shed." A description of the Air Basin in the County, as designated by CARB, is provided in the paragraph below. Air pollution is directly related to the region's topographic features, which impact air movement within the Basin.

Wind patterns within the SJVAB result from marine air that generally flows into the Basin from the San Joaquin River Delta. The Coastal Range hinders wind access into the Valley from the west, the Tehachapi's prevent southerly passage of airflow, and the high Sierra Nevada Mountain Range provides a significant barrier to the east. These topographic features result in weak airflow that becomes restricted vertically by high barometric pressure over the Valley. As a result, the SJVAB is highly susceptible to pollutant accumulation over time. Most of the surrounding mountains are above the normal height of summer inversion layers (1,500-3,000 feet).

### 2.3 Climate Conditions

Fresno County is located in one of the most polluted air basins in the country. Temperature inversions can trap air within the Valley, thereby preventing the vertical dispersal of air pollutants. In addition to topographic conditions, the local climate can also contribute to air quality problems. Climate in much of Fresno County is characterized by warm, dry summers and cool winters with significant Tule fog.

Ozone, classified as a “regional” pollutant, often afflicts areas downwind of the original source of precursor emissions. Ozone can be easily transported by winds from a source area. Peak ozone levels tend to be higher in the southern portion of the Valley, as the prevailing summer winds sweep precursors downwind of northern source areas before concentrations peak. The separate designations reflect the fact that ozone precursor transport depends on daily meteorological conditions.

Other primary pollutants, carbon monoxide (CO), for example, may form high concentrations when wind speed is low. During the winter, Fresno County experiences cold temperatures and calm conditions that increase the likelihood of a climate conducive to high CO concentrations.

Precipitation and fog tend to reduce or limit some pollutant concentrations. Ozone needs sunlight for its formation, and clouds and fog block the required radiation. CO is slightly water-soluble, so precipitation and fog tends to “reduce” CO concentrations in the atmosphere. PM10 is somewhat “washed” from the atmosphere with precipitation. Precipitation in the San Joaquin Valley is strongly influenced by the position of the semi-permanent subtropical high-pressure belt located off the Pacific coast. In the winter, this high- pressure system moves southward, allowing Pacific storms to move through the San Joaquin Valley. These storms bring in moist, maritime air that produces considerable precipitation on the western, upslope side of the Coast Ranges. Significant precipitation also occurs on the western side of the Sierra Nevada. On the valley floor, however, there is some down slope flow from the Coast Ranges and the resultant evaporation of moisture from associated warming results in a minimum of precipitation. Nevertheless, the majority of the precipitation falling in the San Joaquin Valley is produced by those storms during the winter. Precipitation during the summer months is in the form of convective rain showers and is rare. It is usually associated with an influx of moisture into the San Joaquin Valley through the San Francisco area during an anomalous flow pattern in the lower layers of the atmosphere. Although the hourly rates of precipitation from these storms may be high, their rarity keeps monthly totals low.

Precipitation on the San Joaquin Valley floor and in the Sierra Nevada decreases from north to south. Stockton in the north receives about 20 inches of precipitation per year, Fresno in the center, receives about 10 inches per year, and Bakersfield at the southern end of the valley receives less than 6 inches per year. This is primarily because the Pacific storm track often passes through the northern part of the state while the southern part of the state remains protected by the Pacific High. Precipitation in the San Joaquin Valley Air Basin (SJVAB) is confined primarily to the winter months with some also occurring in late summer and fall. Average annual rainfall for the entire San Joaquin Valley is approximately 5 to 16 inches. Snowstorms, hailstorms, and ice storms occur infrequently in the San Joaquin Valley and severe occurrences of any of these are very rare.

The winds and unstable air conditions experienced during the passage of storms result in periods of low pollutant concentrations and excellent visibility. Between winter storms, high pressure and light winds allow cold moist air to pool on the San Joaquin Valley floor. This creates strong

low-level temperature inversions and very stable air conditions. This situation leads to the San Joaquin Valley's famous Tule Fogs. The formation of natural fog is caused by local cooling of the atmosphere until it is saturated (dew point temperature). This type of fog, known as radiation fog, is more likely to occur inland. Cooling may also be accomplished by heat radiation losses or by horizontal movement of a mass of air over a colder surface. This second type of fog, known as advection fog, generally occurs along the coast.

Conditions favorable to fog formation are also conditions favorable to high concentrations of CO and PM10. Ozone levels are low during these periods because of the lack of sunlight to drive the photochemical reaction. Maximum CO concentrations tend to occur on clear, cold nights when a strong surface inversion is present and large numbers of fireplaces are in use. A secondary peak in CO concentrations occurs during morning commute hours when a large number of motorists are on the road and the surface inversion has not yet broken.

The water droplets in fog, however, can act as a sink for CO and nitrogen oxides (NO<sub>x</sub>), lowering pollutant concentrations. At the same time, fog could help in the formation of secondary particulates such as ammonium sulfate. These secondary particulates are believed to be a significant contributor of winter season violations of the PM10 and PM2.5 standards.

## 2.4 Anthropogenic (Man-made) Sources

In addition to climatic conditions (wind, lack of rain, etc.), air pollution can be caused by anthropogenic or man-made sources. Air pollution in the SJVAB can be directly attributed to human activities, which cause air pollutant emissions. Human causes of air pollution in the Valley consist of population growth, urbanization (gas-fired appliances, residential wood heaters, etc.), mobile sources (i.e., cars, trucks, airplanes, trains, etc.), oil production, agriculture, and other socioeconomic activities. The most significant factors, which are accelerating the decline of air quality in the SJVAB, are the Valley's rapid population growth and its associated increases in traffic, urbanization, and industrial activity.

Carbon monoxide emissions overwhelmingly come from mobile sources in the San Joaquin Valley; on-road vehicles contributed 34 percent, while other mobile vehicles, such as trains, planes, and off-road vehicles, contribute another 20 percent in 2012 according to emission projections from the CARB. Motor vehicles account for significant portions of regional gaseous and particulate emissions. Local large employers such as industrial plants can also generate substantial regional gaseous and particulate emissions. In addition, construction and agricultural activities can generate significant temporary gaseous and particulate emissions (dust, ash, smoke, etc.).

Ozone is the result of a photochemical reaction between Oxides of nitrogen (NO<sub>x</sub>) and Reactive Organic Gases (ROG). Mobile sources contribute 84 percent of all NO<sub>x</sub> emitted from anthropogenic sources based on data provided in Appendix B of the Air District's 2016 Ozone

Plan. In addition, mobile sources contribute 26 percent of all the ROG emitted from sources within the San Joaquin Valley.

The principal factors that affect air quality in and around Fresno County are:

1. The sink effect, climatic subsidence and temperature inversions and low wind speeds
2. Automobile and truck travel
3. Increases in mobile and stationary pollutants generated by local urban growth

Automobiles, trucks, buses and other vehicles using hydrocarbon (HC) fuels release exhaust products into the air. Each vehicle by itself does not release large quantities; however, when considered as a group, the cumulative effect is significant.

Other sources may not seem to fit into any one of the major categories or they may seem to fit in a number of them. These could include agricultural uses, dirt roads, animal shelters; animal feed lots, chemical plants and industrial waste disposal, which may be a source of dust, odors, or other pollutants. For Fresno County, this category includes several agriculturally related activities, such as plowing, harvesting, dusting with herbicides and pesticides and other related activities. Finally, industrial contaminants and their potential to produce various effects depend on the size and type of industry, pollution controls, local topography, and meteorological conditions. Major sources of industrial emissions in Fresno County consist of agricultural production and processing operations.

The primary contributors of PM<sub>10</sub> emissions in the San Joaquin Valley are farming activities (22%) and road dust, both paved and unpaved (35%) in 2020 according to emission projections from the CARB. Fugitive windblown dust from “open” fields contributed 14 percent of the PM<sub>10</sub>.

The four major sources of air pollutant emissions in the SJVAB include industrial plants, motor vehicles, construction activities, and agricultural activities. Industrial plants account for significant portions of regional gaseous and particulate emissions. Motor vehicles, including those from large employers, generate substantial regional gaseous and particulate emissions. Finally, construction and agricultural activities can generate significant temporary gaseous and particulate emissions (dust, ash, smoke, etc.). In addition to these primary sources of air pollution, urban areas upwind from Fresno County including areas north and west of the San Joaquin Valley, can cause or generate emissions that are transported into Fresno County. All four of the major pollutant sources affect ambient air quality throughout the Air Basin.

#### 2.4.1 Motor Vehicles

Automobiles, trucks, buses and other vehicles using hydrocarbon fuels release exhaust products into the air. Each vehicle by itself does not release large quantities; however, when considered as a group, the cumulative effect is significant.



### 2.4.2 *Agricultural and Other Miscellaneous Activities*

Other sources may not seem to fit into any one of the major categories or they may seem to fit in a number of them. These could include agricultural uses, dirt roads, animal shelters, animal feed lots, chemical plants and industrial waste disposal, which may be a source of dust, odors, or other pollutants. For Fresno County, this category includes several agriculturally related activities, such as plowing, harvesting, dusting with herbicides and pesticides and other related activities.

### 2.4.3 *Industrial Plants*

Industrial contaminants and their potential to produce various effects depend on the size and type of industry, pollution controls, local topography, and meteorological conditions. Major sources of industrial emissions in Fresno County consist of agricultural production and processing operations.

## 2.5 San Joaquin Valley Air Basin Monitoring

SJVAPCD and the CARB maintain numerous air quality monitoring sites throughout each County in the Air Basin to measure ozone, PM<sub>2.5</sub>, and PM<sub>10</sub>. It is important to note that the federal ozone 1-hour standard was revoked by the EPA and is no longer applicable for federal standards. The closest monitoring station to the Project is located at Fresno's Drummond Monitoring Station. The station monitors particulates and ozone. Monitoring data for the past three years for which data is available is summarized in Table 2.

Table 3 identifies the Fresno County's attainment status. As indicated, the SJVAB is nonattainment for Ozone (1 hour and 8 hour) and PM. In accordance with the FCAA, EPA uses the design value at the time of standard promulgation to assign nonattainment areas to one of several classes that reflect the severity of the nonattainment problem; classifications range from marginal nonattainment to extreme nonattainment. The FCAA contains provisions for changing the classifications using factors such as clean air progress rates and requests from States to move areas to a higher classification.

On April 16, 2004, EPA issued a final rule classifying the SJVAB as extreme nonattainment for Ozone, effective May 17, 2004 (69 FR 20550). The (federal) 1-hour ozone standard was revoked on June 6, 2005. However, many of the requirements in the 1-hour attainment plan (SIP) continue to apply to the SJVAB. The current ozone plan is the (federal) 8-hour ozone plan adopted in 2007. The SJVAB was reclassified from a "serious" nonattainment area for the 8-hour ozone standard to "extreme" effective June 4, 2010.

**Table 2**  
**Maximum Pollutant Levels at Fresno's  
Drummond Monitoring Station**

Pollutant	Time Averaging	2016	2017	2018	Standards	
		Maximums	Maximums	Maximums	National	State
Ozone (O <sub>3</sub> )	1 hour	0.102 ppm	0.114 ppm	0.108 ppm	-	0.09 ppm
Ozone (O <sub>3</sub> )	8 hour	0.088 ppm	0.099 ppm	0.095 ppm	0.070 ppm	0.070 ppm
Nitrogen Dioxide (NO <sub>2</sub> )	1 hour	47.2 ppb	58.6 ppb	67.2 ppb	100 ppb	0.18 ppm
Nitrogen Dioxide (NO <sub>2</sub> )	Annual Average	9.0 ppb	9.0 ppb	9.0 ppb	0.053 ppm	0.030 ppm
Particulates (PM <sub>10</sub> )	24 hour	62.3 µg/m <sup>3</sup>	111.7 µg/m <sup>3</sup>	238.7 µg/m <sup>3</sup>	150 µg/m <sup>3</sup>	50 µg/m <sup>3</sup>
Particulates (PM <sub>10</sub> )	Federal Annual Arithmetic Mean	29.8 µg/m <sup>3</sup>	36.4 µg/m <sup>3</sup>	36.8 µg/m <sup>3</sup>	-	20 µg/m <sup>3</sup>
Particulates (PM <sub>2.5</sub> )	24 hour	53.6 µg/m <sup>3</sup>	72.3 µg/m <sup>3</sup>	187.3 µg/m <sup>3</sup>	35 µg/m <sup>3</sup>	-
Particulates (PM <sub>2.5</sub> )	Federal Annual Arithmetic Mean	12.6 µg/m <sup>3</sup>	12.7 µg/m <sup>3</sup>	17.2 µg/m <sup>3</sup>	12 µg/m <sup>3</sup>	12 µg/m <sup>3</sup>

Source: California Air Resources Board (ADAM) Air Pollution Summaries

Source: CARB (ADAM) Air Pollution Summaries

**Table 3**  
**Fresno County Attainment Status**

Pollutant	Designation/Classification	
	Federal Standards	State Standards
Ozone - 1 Hour	Revoked in 2005	Nonattainment
Ozone - 8 Hour	Nonattainment/Extreme	Nonattainment
PM10	Attainment	Nonattainment
PM2.5	Nonattainment	Nonattainment
Carbon Monoxide	Unclassified/Attainment	Unclassified
Nitrogen Dioxide	Unclassified/Attainment	Attainment
Sulfur Dioxide	Unclassified/Attainment	Attainment
Lead (Particulate)	Unclassified/Attainment	Attainment
Hydrogen Sulfide	No Federal Standard	Unclassified
Sulfates	No Federal Standard	Attainment
Visibility Reducing Particles	No Federal Standard	Unclassified

Source: CARB Website, 2022

a. Though the Valley was initially classified as serious nonattainment for the 1997 8-hour ozone standard, EPA approved Valley reclassification to extreme nonattainment in the Federal Register on May 5, 2010 (effective June 4, 2010).

Notes:

National Designation Categories

Non-Attainment Area: Any area that does not meet (or that contributes to ambient air quality in a nearby area that does not meet) the national primary or secondary ambient air quality standard for the pollutant.

Unclassified/Attainment Area: Any area that cannot be classified on the basis of available information as meeting or not meeting the national primary or secondary ambient air quality standard for the pollutant or meets the national primary or secondary ambient air quality standard for the pollutant.

State Designation Categories

Unclassified: A pollutant is designated unclassified if the data are incomplete and do not support a designation of attainment or non-attainment.

Attainment: A pollutant is designated attainment if the State standard for that pollutant was not violated at any site in the area during a three-year period.

Non-attainment: A pollutant is designated non-attainment if there was at least one violation of a State standard for that pollutant in the area.

Non-Attainment/Transitional: A subcategory of the non-attainment designation. An area is designated non-attainment/transitional to signify that the area is close to attaining the standard for the pollutant.

## 2.6 Air Quality Standards

The FCAA, first adopted in 1963, and periodically amended since then, established National Ambient Air Quality Standards (NAAQS). A set of 1977 amendments determined a deadline for the attainment of these standards. That deadline has since passed. Other CAA amendments, passed in 1990, share responsibility with the State in reducing emissions from mobile sources.

In 1988, the State of California passed the CCAA (State 1988 Statutes, Chapter 568), which set

forth a program for achieving more stringent California Ambient Air Quality Standards. The CARB implements State ambient air quality standards, as required in the CCAA, and cooperates with the federal government in implementing pertinent sections of the FCAA Amendments (FCAAA). Further, CARB regulates vehicular emissions throughout the State. The SJVAPCD regulates stationary sources, as well as some mobile sources. Attainment of the more stringent State PM10 Air Quality Standards is not currently required.

The EPA uses six "criteria pollutants" as indicators of air quality and has established for each of them a maximum concentration above which adverse effects on human health may occur. These threshold concentrations are called the NAAQS.

The SJVAPCD operates regional air quality monitoring networks that provide information on average concentrations of pollutants for which State or federal agencies have established ambient air quality standards. Descriptions of nine pollutants of importance in Fresno County follow.

### 2.6.1 Ozone (1-hour and 8-hour)

The most severe air quality problem in the Air Basin is the high level of ozone. Ozone occurs in two layers of the atmosphere. The layer surrounding the earth's surface is the troposphere. Here, ground level, or "bad" ozone, is an air pollutant that damages human health, vegetation, and many common materials. It is a key ingredient of urban smog. The troposphere extends to a level about 10 miles up, where it meets the second layer, the stratosphere. The stratospheric, or "good" ozone layer, extends upward from about 10 to 30 miles and protects life on earth from the sun's harmful ultraviolet rays.

"Bad" ozone is what is known as a photochemical pollutant. It needs reactive organic gases (ROG), NO<sub>x</sub>, and sunlight. ROG and NO<sub>x</sub> are emitted from various sources throughout Tulare County. In order to reduce ozone concentrations, it is necessary to control the emissions of these ozone precursors.

Significant ozone formation generally requires an adequate amount of precursors in the atmosphere and several hours in a stable atmosphere with strong sunlight. High ozone concentrations can form over large regions when emissions from motor vehicles and stationary sources are carried hundreds of miles from their origins.

Ozone is a regional air pollutant. It is generated over a large area and is transported and spread by wind. Ozone, the primary constituent of smog, is the most complex, difficult to control, and pervasive of the criteria pollutants. Unlike other pollutants, ozone is not emitted directly into the air by specific sources. Ozone is created by sunlight acting on other air pollutants (called precursors), specifically NO<sub>x</sub> and ROG. Sources of precursor gases to the photochemical reaction that form ozone number in the thousands. Common sources include consumer products, gasoline vapors, chemical solvents, and combustion products of various fuels. Originating from

gas stations, motor vehicles, large industrial facilities, and small businesses such as bakeries and dry cleaners, the ozone-forming chemical reactions often take place in another location, catalyzed by sunlight and heat. High ozone concentrations can form over large regions when emissions from motor vehicles and stationary sources are carried hundreds of miles from their origins. Approximately 50 million people lived in counties with air quality levels above the EPA's health-based national air quality standard in 1994. The highest levels of ozone were recorded in Los Angeles, closely followed by the San Joaquin Valley. High levels also persist in other heavily populated areas, including the Texas Gulf Coast and much of the Northeast.

While the ozone in the upper atmosphere absorbs harmful ultraviolet light, ground-level ozone is damaging to the tissues of plants, animals, and humans, as well as to a wide variety of inanimate materials such as plastics, metals, fabrics, rubber, and paints. Societal costs from ozone damage include increased medical costs, the loss of human and animal life, accelerated replacement of industrial equipment, and reduced crop yields.

### ✓ **Health Effects**

While ozone in the upper atmosphere protects the earth from harmful ultraviolet radiation, high concentrations of ground-level ozone can adversely affect the human respiratory system. Many respiratory ailments, as well as cardiovascular disease, are aggravated by exposure to high ozone levels. Ozone also damages natural ecosystems, such as: forests and foothill communities; agricultural crops; and some man-made materials, such as rubber, paint, and plastic. High levels of ozone may negatively affect immune systems, making people more susceptible to respiratory illnesses, including bronchitis and pneumonia. Ozone accelerates aging and exacerbates pre-existing asthma and bronchitis and, in cases with high concentrations, can lead to the development of asthma in active children. Active people, both children and adults, appear to be more at risk from ozone exposure than those with a low level of activity. Additionally, the elderly and those with respiratory disease are also considered sensitive populations for ozone.

People who work or play outdoors are at a greater risk for harmful health effects from ozone. Children and adolescents are also at greater risk because they are more likely than adults to spend time engaged in vigorous activities. Research indicates that children under 12 years of age spend nearly twice as much time outdoors daily than adults. Teenagers spend at least twice as much time as adults in active sports and outdoor activities. In addition, children inhale more air per pound of body weight than adults, and they breathe more rapidly than adults. Children are less likely than adults to notice their own symptoms and avoid harmful exposures.

Ozone is a powerful oxidant—it can be compared to household bleach, which can kill living cells (such as germs or human skin cells) upon contact. Ozone can damage the respiratory tract, causing inflammation and irritation, and it can induce symptoms such as coughing, chest tightness, shortness of breath, and worsening of asthmatic symptoms. Ozone in



sufficient doses increases the permeability of lung cells, rendering them more susceptible to toxins and microorganisms. Exposure to levels of ozone above the current ambient air quality standard leads to lung inflammation and lung tissue damage and a reduction in the amount of air inhaled into the lungs.

### 2.6.2 *Suspended PM (PM10 and PM2.5)*

Particulate matter pollution consists of very small liquid and solid particles that remain suspended in the air for long periods. Some particles are large or concentrated enough to be seen as soot or smoke. Others are so small they can be detected only with an electron microscope. Particulate matter is a mixture of materials that can include smoke, soot, dust, salt, acids, and metals. Particulate matter is emitted from stationary and mobile sources, including diesel trucks and other motor vehicles; power plants; industrial processes; wood-burning stoves and fireplaces; wildfires; dust from roads, construction, landfills, and agriculture; and fugitive windblown dust. PM10 refers to particles less than or equal to 10 microns in aerodynamic diameter. PM2.5 refers to particles less than or equal to 2.5 microns in aerodynamic diameter and are a subset of PM10. Particulates of concern are those that are 10 microns or less in diameter. These are small enough to be inhaled, pass through the respiratory system and lodge in the lungs, possibly leading to adverse health effects.

In the western United States, there are sources of PM10 in both urban and rural areas. Because particles originate from a variety of sources, their chemical and physical compositions vary widely. The composition of PM10 and PM2.5 can also vary greatly with time, location, the sources of the material and meteorological conditions. Dust, sand, salt spray, metallic and mineral particles, pollen, smoke, mist, and acid fumes are the main components of PM10 and PM2.5. In addition to those listed previously, secondary particles can also be formed as precipitates from chemical and photochemical reactions of gaseous sulfur dioxide (SO<sub>2</sub>) and NO<sub>x</sub> in the atmosphere to create sulfates (SO<sub>4</sub>) and nitrates (NO<sub>3</sub>). Secondary particles are of greatest concern during the winter months where low inversion layers tend to trap the precursors of secondary particulates.

The District's 2008 PM2.5 Plan built upon the aggressive emission reduction strategy adopted in the 2007 Ozone Plan and strives to bring the valley into attainment status for the 1997 NAAQS for PM2.5. The District's 2012 PM2.5 Plan provides multiple control strategies to reduce emissions of PM2.5 and other pollutants that form PM2.5. The plan's comprehensive control strategy includes regulatory actions, incentive programs, technology advancement, policy and legislative positions, public outreach, participation and communication, and additional strategies.

#### ✓ **Health Effects**

PM10 and PM2.5 particles are small enough—about one-seventh the thickness of a human hair, or smaller—to be inhaled and lodged in the deepest parts of the lung where they evade

the respiratory system's natural defenses. Health problems begin as the body reacts to these foreign particles. Acute and chronic health effects associated with high particulate levels include the aggravation of chronic respiratory diseases, heart and lung disease, and coughing, bronchitis, and respiratory illnesses in children. Recent mortality studies have shown a statistically significant direct association between mortality and daily concentrations of particulate matter in the air. Non-health-related effects include reduced visibility and soiling of buildings. PM10 can increase the number and severity of asthma attacks, cause or aggravate bronchitis and other lung diseases, and reduce the body's ability to fight infections. PM10 and PM2.5 can aggravate respiratory disease and cause lung damage, cancer, and premature death.

Although particulate matter can cause health problems for everyone, certain people are especially vulnerable to adverse health effects of PM10. These "sensitive populations" include children, the elderly, exercising adults, and those suffering from chronic lung disease such as asthma or bronchitis. Of greatest concern are recent studies that link PM10 exposure to the premature death of people who already have heart and lung disease, especially the elderly. Acidic PM10 can also damage manmade materials and is a major cause of reduced visibility in many parts of the United States.

### 2.6.3 Carbon Monoxide (CO)

Carbon monoxide (CO) is emitted by mobile and stationary sources as a result of incomplete combustion of hydrocarbons or other carbon-based fuels. CO is an odorless, colorless, poisonous gas that is highly reactive. CO is a byproduct of motor vehicle exhaust, contributes more than two thirds of all CO emissions nationwide. In cities, automobile exhaust can cause as much as 95 percent of all CO emissions. These emissions can result in high concentrations of CO, particularly in local areas with heavy traffic congestion. Other sources of CO emissions include industrial processes and fuel combustion in sources such as boilers and incinerators. Despite an overall downward trend in concentrations and emissions of CO, some metropolitan areas still experience high levels of CO.

#### ✓ **Health Effects**

CO enters the bloodstream and binds more readily to hemoglobin than oxygen, reducing the oxygen-carrying capacity of blood and thus reducing oxygen delivery to organs and tissues. The health threat from CO is most serious for those who suffer from cardiovascular disease. Healthy individuals are also affected but only at higher levels of exposure. At high concentrations, CO can cause heart difficulties in people with chronic diseases and can impair mental abilities. Exposure to elevated CO levels is associated with visual impairment, reduced work capacity, reduced manual dexterity, poor learning ability, difficulty performing complex tasks, and in prolonged, enclosed exposure, death.

The adverse health effects associated with exposure to ambient and indoor concentrations

of CO are related to the concentration of carboxyhemoglobin (COHb) in the blood. Health effects observed may include an early onset of cardiovascular disease; behavioral impairment; decreased exercise performance of young, healthy men; reduced birth weight; sudden infant death syndrome (SIDS); and increased daily mortality rate.

Most of the studies evaluating adverse health effects of CO on the central nervous system examine high-level poisoning. Such poisoning results in symptoms ranging from common flu and cold symptoms (shortness of breath on mild exertion, mild headaches, and nausea) to unconsciousness and death.

#### 2.6.4 Nitrogen Dioxide (NO<sub>2</sub>)

Nitrogen oxides (NO<sub>x</sub>) is a family of highly reactive gases that are primary precursors to the formation of ground-level ozone and react in the atmosphere to form acid rain. NO<sub>x</sub> is emitted from combustion processes in which fuel is burned at high temperatures, principally from motor vehicle exhaust and stationary sources such as electric utilities and industrial boilers. A brownish gas, NO<sub>x</sub> is a strong oxidizing agent that reacts in the air to form corrosive nitric acid, as well as toxic organic nitrates. EPA regulates only nitrogen dioxide (NO<sub>2</sub>) as a surrogate for this family of compounds because it is the most prevalent form of NO<sub>x</sub> in the atmosphere that is generated by anthropogenic (human) activities.<sup>1</sup>

##### ✓ Health Effects

NO<sub>x</sub> is an ozone precursor that combines with Reactive Organic Gases (ROG) to form ozone. See the ozone section above for a discussion of the health effects of ozone.

Direct inhalation of NO<sub>x</sub> can also cause a wide range of health effects. NO<sub>x</sub> can irritate the lungs, cause lung damage, and lower resistance to respiratory infections such as influenza. Short-term exposures (e.g., less than 3 hours) to low levels of nitrogen dioxide (NO<sub>2</sub>) may lead to changes in airway responsiveness and lung function in individuals with preexisting respiratory illnesses. These exposures may also increase respiratory illnesses in children. Long-term exposures to NO<sub>2</sub> may lead to increased susceptibility to respiratory infection and may cause irreversible alterations in lung structure. Other health effects associated with NO<sub>x</sub> are an increase in the incidence of chronic bronchitis and lung irritation. Chronic exposure to NO<sub>2</sub> may lead to eye and mucus membrane aggravation, along with pulmonary dysfunction. NO<sub>x</sub> can cause fading of textile dyes and additives, deterioration of cotton and nylon, and corrosion of metals due to production of particulate nitrates. Airborne NO<sub>x</sub> can also impair visibility. NO<sub>x</sub> is a major component of acid deposition in California. NO<sub>x</sub> may affect both terrestrial and aquatic ecosystems. NO<sub>x</sub> in the air is a potentially significant contributor to a number of environmental effects such as acid rain and eutrophication in coastal waters. Eutrophication occurs when a body of water suffers an increase in nutrients that reduce the

---

<sup>1</sup> United States Environmental Protection Agency (EPA), Nitrogen Oxides (NO<sub>x</sub>). Why and How They Are Controlled, 456/F-99-006R, November 2019

amount of oxygen in the water, producing an environment that is destructive to fish and other animal life.

NO<sub>2</sub> is toxic to various animals as well as to humans. Its toxicity relates to its ability to combine with water to form nitric acid in the eye, lung, mucus membranes, and skin. Studies of the health impacts of NO<sub>2</sub> include experimental studies on animals, controlled laboratory studies on humans, and observational studies.

In animals, long-term exposure to NO<sub>x</sub> increases susceptibility to respiratory infections, lowering their resistance to such diseases as pneumonia and influenza. Laboratory studies show susceptible humans, such as asthmatics, exposed to high concentrations of NO<sub>2</sub>, can suffer lung irritation and, potentially, lung damage. Epidemiological studies have also shown associations between NO<sub>2</sub> concentrations and daily mortality from respiratory and cardiovascular causes as well as hospital admissions for respiratory conditions.

NO<sub>x</sub> contributes to a wide range of environmental effects both directly and when combined with other precursors in acid rain and ozone. Increased nitrogen inputs to terrestrial and wetland systems can lead to changes in plant species composition and diversity. Similarly, direct nitrogen inputs to aquatic ecosystems such as those found in estuarine and coastal waters can lead to eutrophication as discussed above. Nitrogen, alone or in acid rain, also can acidify soils and surface waters. Acidification of soils causes the loss of essential plant nutrients and increased levels of soluble aluminum, which is toxic to plants. Acidification of surface waters creates conditions of low pH and levels of aluminum that are toxic to fish and other aquatic organisms.

### 2.6.5 Sulfur Dioxide (SO<sub>2</sub>)

The major source of sulfur dioxide (SO<sub>2</sub>) is the combustion of high-sulfur fuels for electricity generation, petroleum refining and shipping. High concentrations of SO<sub>2</sub> can result in temporary breathing impairment for asthmatic children and adults who are active outdoors. Short-term exposures of asthmatic individuals to elevated SO<sub>2</sub> levels during moderate activity may result in breathing difficulties that can be accompanied by symptoms such as wheezing, chest tightness, or shortness of breath. Other effects that have been associated with longer-term exposures to high concentrations of SO<sub>2</sub>, in conjunction with high levels of PM, include aggravation of existing cardiovascular disease, respiratory illness, and alterations in the lungs' defenses. SO<sub>2</sub> also is a major precursor to PM<sub>2.5</sub>, which is a significant health concern and a main contributor to poor visibility. In humid atmospheres, sulfur oxides can react with vapor to produce sulfuric acid, a component of acid rain.

### 2.6.6 Lead (Pb)

Lead, a naturally occurring metal, can be a constituent of air, water, and the biosphere. Lead is neither created nor destroyed in the environment, so it essentially persists forever. Lead was used until recently to increase the octane rating in automobile fuel. Since the 1980s, lead has

been phased out in gasoline, reduced in drinking water, reduced in industrial air pollution, and banned or limited in consumer products. Gasoline-powered automobile engines were a major source of airborne lead through the use of leaded fuels; however, the use of leaded fuel has been mostly phased out. Since this has occurred the ambient concentrations of lead have dropped dramatically.

Exposure to lead occurs mainly through inhalation of air and ingestion of lead in food, water, soil, or dust. It accumulates in the blood, bones, and soft tissues and can adversely affect the kidneys, liver, nervous system, and other organs. Excessive exposure to lead may cause neurological impairments such as seizures, mental retardation, and behavioral disorders. Even at low doses, lead exposure is associated with damage to the nervous systems of fetuses and young children. Effects on the nervous systems of children are one of the primary health risk concerns from lead. In high concentrations, children can even suffer irreversible brain damage and death. Children 6 years old and under are most at risk, because their bodies are growing quickly.

### 2.6.7 Toxic Air Contaminants (TAC)

In addition to the criteria pollutants discussed above, Toxic Air Contaminants (TAC) are another group of pollutants of concern. TAC are injurious in small quantities and are regulated despite the absence of criteria documents. The identification, regulation and monitoring of TAC is relatively recent compared to that for criteria pollutants. Unlike criteria pollutants, TAC are regulated on the basis of risk rather than specification of safe levels of contamination. The ten TAC are acetaldehyde, benzene, 1,3-butadiene, carbon tetrachloride, hexavalent chromium, para-dichlorobenzene, formaldehyde, methylene chloride, perchloroethylene, and diesel particulate matter (diesel PM). Caltrans' guidance for transportation studies references the Federal Highway Administration (FHWA) memorandum titled "Interim Guidance on Air Toxic Analysis in NEPA Documents" which discusses emissions quantification of six "priority" compounds of 21 Mobile Source Air Toxics (MSAT) identified by the United States Environmental Protection Agency (USEPA). The six "priority" compounds are diesel exhaust (particulate matter and organic gases), benzene, 1,3-butadiene, acetaldehyde, formaldehyde, and acrolein.

Some studies indicate that diesel PM poses the greatest health risk among the TAC listed above. A 10-year research program (California Air Resources Board 1998) demonstrated that diesel PM from diesel-fueled engines is a human carcinogen and that chronic (long-term) inhalation exposure to diesel PM poses a chronic health risk. In addition to increasing the risk of lung cancer, exposure to diesel exhaust can have other health effects. Diesel exhaust can irritate the eyes, nose, throat, and lungs, and it can cause coughs, headaches, lightheadedness, and nausea. Diesel exhaust is a major source of fine particulate pollution as well, and studies have linked elevated particle levels in the air to increased hospital admissions, emergency room visits, asthma attacks, and premature deaths among those suffering from respiratory problems.

Diesel PM differs from other TAC in that it is not a single substance but a complex mixture of hundreds of substances. Although diesel PM is emitted by diesel-fueled, internal combustion engines, the composition of the emissions varies, depending on engine type, operating



conditions, fuel composition, lubricating oil, and whether an emission control system is present. Unlike the other TAC, however, no ambient monitoring data are available for diesel PM because no routine measurement method currently exists. The CARB has made preliminary concentration estimates based on a diesel PM exposure method. This method uses the CARB emissions inventory's PM10 database, ambient PM10 monitoring data, and the results from several studies to estimate concentrations of diesel PM. Table 4 depicts the CARB Handbook's recommended buffer distances associated with various types of common sources.

Existing air quality concerns within Fresno County and the entire SJVAB are related to increases of regional criteria air pollutants (e.g., ozone and particulate matter), exposure to toxic air contaminants, odors, and increases in greenhouse gas emissions contributing to climate change. The primary source of ozone (smog) pollution is motor vehicles. Particulate matter is caused by dust, primarily dust generated from construction and grading activities, and smoke which is emitted from fireplaces, wood-burning stoves, and agricultural burning.

**TABLE 4**  
**Recommendations on Siting New Sensitive Land Uses Such As Residences, Schools, Daycare Centers, Playgrounds, or Medical Facilities\***

SOURCE CATEGORY	ADVISORY RECOMMENDATIONS
Freeways and High-Traffic Roads <sup>1</sup>	- Avoid siting new sensitive land uses within 500 feet of a freeway, urban roads with 100,000 vehicles/day, or rural roads with 50,000 vehicles/day.
Distribution Centers	- Avoid siting new sensitive land uses within 1,000 feet of a distribution center (that accommodates more than 100 trucks per day, more than 40 trucks with operating transport refrigeration units (TRUs) per day, or where TRU unit operations exceed 300 hours per week).  - Take into account the configuration of existing distribution centers and avoid locating residences and other new sensitive land uses near entry and exit points.
Rail Yards	- Avoid siting new sensitive land uses within 1,000 feet of a major service and maintenance rail yard.  - Within one mile of a rail yard, consider possible siting limitations and mitigation approaches.
Ports	- Avoid siting of new sensitive land uses immediately downwind of ports in the most heavily impacted zones. Consult local air districts or the ARB on the status of pending analyses of health risks.
Refineries	- Avoid siting new sensitive land uses immediately downwind of petroleum refineries. Consult with local air districts and other local agencies to determine an appropriate separation.
Chrome Platers	- Avoid siting new sensitive land uses within 1,000 feet of a chrome plater.
Dry Cleaners Using Perchloroethylene	- Avoid siting new sensitive land uses within 300 feet of any dry cleaning operation. For operations with two or more machines, provide 500 feet. For operations with 3 or more machines, consult with the local air district.  - Do not site new sensitive land uses in the same building with perchloroethylene dry cleaning operations.
Gasoline Dispensing Facilities	- Avoid siting new sensitive land uses within 300 feet of a large gas station (defined as a facility with a throughput of 3.6 million gallons per year or greater). A 50 foot separation is recommended for typical gas dispensing facilities.

1: The recommendation to avoid siting new sensitive land uses within 500 feet of a freeway was identified in CARB's Air Quality and Land Use Handbook published in 2005. CARB recently published a technical advisory to the Air Quality and Land Use Handbook indicating that new research has demonstrated promising strategies to reduce pollution exposure along transportation corridors.

\*Notes:

- These recommendations are advisory. Land use agencies have to balance other considerations, including housing and transportation needs, economic development priorities, and other quality of life issues.
- Recommendations are based primarily on data showing that the air pollution exposures addressed here (i.e., localized) can be reduced as much as 80% with the recommended separation.
- The relative risk for these categories varies greatly (see Table 1-2). To determine the actual risk near a particular facility, a site-specific analysis would be required. Risk from diesel PM will decrease over time as cleaner technology phases in.
- These recommendations are designed to fill a gap where information about existing facilities may not be readily available and are not designed to substitute for more specific information if it exists. The recommended distances take into account other factors in addition to available health risk data (see individual category descriptions).
- Site-specific project design improvements may help reduce air pollution exposures and should also be considered when siting new sensitive land uses.
- This table does not imply that mixed residential and commercial development in general is incompatible. Rather it focuses on known problems like dry cleaners using perchloroethylene that can be addressed with reasonable preventative actions.
- A summary of the basis for the distance recommendations can be found in the ARB Handbook: Air Quality and Land Use Handbook: A Community Health Perspective.

Source: SJVAPCD 2020

### 2.6.8 Odors

Typically, odors are regarded as an annoyance rather than a health hazard. However, manifestations of a person's reaction to foul odors can range from psychological (e.g., irritation, anger, or anxiety) to physiological (e.g., circulatory and respiratory effects, nausea, vomiting, and headache).

With respect to odors, the human nose is the sole sensing device. The ability to detect odors varies considerably among the population and overall is quite subjective. Some individuals have the ability to smell minute quantities of specific substances; others may not have the same sensitivity but may have sensitivities to odors of other substances. In addition, people may have different reactions to the same odor; in fact, an odor that is offensive to one person (e.g., from a fast-food restaurant) may be perfectly acceptable to another. It is also important to note that an unfamiliar odor is more easily detected and is more likely to cause complaints than a familiar one. This is because of the phenomenon known as odor fatigue, in which a person can become desensitized to almost any odor and recognition only occurs with an alteration in the intensity.

Quality and intensity are two properties present in any odor. The quality of an odor indicates the nature of the smell experience. For instance, if a person describes an odor as flowery or sweet, then the person is describing the quality of the odor. Intensity refers to the strength of the odor. For example, a person may use the word "strong" to describe the intensity of an odor. Odor intensity depends on the odorant concentration in the air.

When an odorous sample is progressively diluted, the odorant concentration decreases. As this occurs, the odor intensity weakens and eventually becomes so low that the detection or recognition of the odor is quite difficult. At some point during dilution, the concentration of the odorant reaches a detection threshold. An odorant concentration below the detection threshold means that the concentration in the air is not detectable by the average human.

The intensity of an odor source's operations and its proximity to sensitive receptors influences the potential significance of odor emissions. The SJVAPCD has identified some common types of facilities that have been known to produce odors in the SJVAB. The types of facilities that are known to produce odors are shown in Table 5 along with a reasonable distance from the source within which, the degree of odors could possibly be significant. The Project does not propose any uses that would be potential odor sources; however, the information presented in Table 5 will be used as a screening level analysis to determine if the Project would be impacted by existing odor sources in the study area. Such information is presented for informational purposes, but it is noted that the environment's effect on the Project, including exposure to potential odors, would not be an impact for CEQA purposes.

**TABLE 5**  
**Screening Levels for Potential Odor Sources**

Type of Facility	Distance
Wastewater Treatment Facilities	2 miles
Sanitary Landfill	1 mile
Transfer Station	1 mile
Compositing Facility	1 mile
Petroleum Refinery	2 miles
Asphalt Batch Plant	1 mile
Chemical Manufacturing	1 mile
Fiberglass Manufacturing	1 mile
Painting/Coating Operations (e.g. auto body shops)	1 mile
Food Processing Facility	1 mile
Feed Lot/Dairy	1 mile
Rendering Plant	1 mile

Source: SJVAPCD 2020

### 2.6.9 Naturally Occurring Asbestos (NOA)

Asbestos is a term used for several types of naturally occurring fibrous minerals found in many parts of California. The most common type of asbestos is chrysotile, but other types are also found in California. Asbestos is commonly found in ultramafic rock and near fault zones. The amount of asbestos that is typically present in these rocks’ ranges from less than 1% up to approximately 25% and sometimes more. It is released from ultramafic rock when it is broken or crushed. This can happen when cars drive over unpaved roads or driveways, which are surfaced with these rocks, when land is graded for building purposes, or at quarrying operations. Asbestos is also released naturally through weathering and erosion. Once released from the rock, asbestos can become airborne and may stay in the air for long periods of time. Asbestos is hazardous and can cause lung disease and cancer dependent upon the level of exposure. The longer a person is exposed to asbestos and the greater the intensity of the exposure, the greater the chances for a health problem.

The proposed Project's construction phase may cause asbestos to become airborne due to the construction activities that will occur on site. The Project would be required to submit a Dust Control Plan under the SJVAPCD’s Rule 8021.

### 2.6.10 Greenhouse Gas Emissions

Gases that trap heat in the atmosphere are often called greenhouse gases. Some greenhouse gases such as carbon dioxide occur naturally and are emitted to the atmosphere through natural processes and human activities. Other greenhouse gases (e.g., fluorinated gases) are created and emitted solely through human activities. The principal greenhouse gases that enter the

atmosphere because of human activities are:

- ✓ **Carbon Dioxide (CO<sub>2</sub>):** Carbon dioxide enters the atmosphere through the burning of fossil fuels (oil, natural gas, and coal), solid waste, trees and wood products, and also as a result of other chemical reactions (e.g., manufacture of cement, asphalt paving, truck trips). Carbon dioxide is also removed from the atmosphere (or "sequestered") when it is absorbed by plants as part of the biological carbon cycle.
- ✓ **Methane (CH<sub>4</sub>):** Methane is emitted during the production and transport of coal, natural gas, and oil. Methane emissions also result from livestock and other agricultural practices and by the decay of organic waste in municipal solid waste landfills.
- ✓ **Nitrous Oxide (N<sub>2</sub>O):** Nitrous oxide is emitted during agricultural and industrial activities, as well as during combustion of fossil fuels and solid waste.
- ✓ **Fluorinated Gases:** Hydrofluorocarbons, perfluorocarbons, and sulfur hexafluoride are synthetic, powerful greenhouse gases that are emitted from a variety of industrial processes. Fluorinated gases are sometimes used as substitutes for ozone-depleting substances (i.e., CFCs, HCFCs, and halons). These gases are typically emitted in smaller quantities, but because they are potent greenhouse gases, they are sometimes referred to as High Global Warming Potential gases ("High GWP gases").

## 3.0 Air-Quality Impacts

### 3.1 Methodology

The impact assessment for air quality focuses on potential effects the Project might have on air quality within the Fresno County region. The SJVAPCD has established thresholds of significance for determining environmental significance. These thresholds separate a project’s short-term emissions from its long-term emissions. The short-term emissions are mainly related to the construction phase of a project, which are recognized to be short in duration. The long-term emissions are primarily related to the activities that will occur indefinitely as a result of Project operations. Impacts will be evaluated both on the basis of CEQA Appendix G criteria and SJVAPCD significance criteria. The impacts to be evaluated will be those involving construction and operational emissions of criteria pollutants. The SJVAPCD has established thresholds for certain pollutants shown in Table 6.

**Table 6**  
**SJVAPCD Air Quality Thresholds of Significance**

Project Type	Ozone Precursor Emissions (tons/year)					
	CO	NO <sub>x</sub>	ROG	SO <sub>x</sub>	PM <sub>10</sub>	PM <sub>2.5</sub>
Construction Emissions	100	10	10	27	15	15
Operational Emissions (Permitted Equipment and Activities)	100	10	10	27	15	15
Operational Emissions (Non-Permitted Equipment and Activities)	100	10	10	27	15	15

Source: SJVAPCD 2020

#### 3.1.1 CalEEMod

CalEEMod is a statewide land use emissions computer model designed to provide a uniform platform for government agencies, land use planners, and environmental professionals to quantify potential criteria pollutant and greenhouse gas (GHG) emissions associated with both construction and operations from a variety of land use projects. The model quantifies direct emissions from construction and operations (including vehicle use), as well as indirect emissions, such as GHG emissions from energy use, solid waste disposal, vegetation planting and/or removal, and water use.

The model is an accurate and comprehensive tool for quantifying air quality impacts from land use projects throughout California. The model can be used for a variety of situations where an air quality analysis is necessary or desirable such as CEQA and NEPA documents, pre-project planning, compliance with local air quality rules and regulations, etc.



### 3.2 Short-Term Impacts

Short-term impacts are mainly related to the construction phase of a project and are recognized to be short in duration. Construction air quality impacts are generally attributable to dust and exhaust pollutants generated by equipment and vehicles. Fugitive dust is emitted both during construction activity and as a result of wind erosion over exposed earth surfaces. Clearing and earth moving activities do comprise major sources of construction dust emissions, but traffic and general disturbances of soil surfaces also generate significant dust emissions. Further, dust generation is dependent on soil type and soil moisture. Exhaust pollutants are the non-useable gaseous waste products produced during the combustion process. Engine exhaust contains CO, HC, and NO<sub>x</sub> pollutants which are harmful to the environment.

Adverse effects of construction activities cause increased dust-fall and locally elevated levels of total suspended particulate. Dust-fall can be a nuisance to neighboring properties or previously completed developments surrounding or within the Project area and may require frequent washing during the construction period.

PM<sub>10</sub> emissions can result from construction activities of the Project. The SJVAPCD has determined that compliance with Regulation VIII and other control measures will constitute sufficient mitigation to reduce PM<sub>10</sub> impacts to a level considered less-than significant for most development projects. Even with implementation of District Regulation VIII and District Rule 9510, large development projects may not be able to reduce project specific construction impacts below District thresholds of significance.

Ozone precursor emissions are also an impact of construction activities and can be quantified through calculations. Numerous variables factored into estimating total construction emission include: level of activity, length of construction period, number of pieces and types of equipment in use, site characteristics, weather conditions, number of construction personnel, and amount of materials to be transported onsite or offsite. Additional exhaust emissions would be associated with the transport of workers and materials. Because the specific mix of construction equipment is not presently known for this Project, construction emissions were estimated using CalEEMod Model defaults for construction equipment.

Table 7 shows the CalEEMod estimated construction emissions that would be generated from construction of the Project. Results of the analysis show that emissions generated from construction of the Project will not exceed the SJVAPCD emission thresholds.

**Table 7**  
**Project Construction Emissions (tons/year)**

Summary Report	CO	NO <sub>x</sub>	ROG	SO <sub>x</sub>	PM <sub>10</sub>	PM <sub>2.5</sub>	CO <sub>2e</sub>
Project Construction Emissions	3.84	6.04	5.58	0.007	3.91	2.12	710.46
SJVAPCD Level of Significance	100	10	10	27	15	15	None
Does the Project Exceed Standard?	No	No	No	No	No	No	No

Source: CalEEMod Summer Emissions

### 3.3 Long-Term Emissions

Long-Term emissions from the Project would be generated primarily by mobile source (vehicle) emissions from the Project site and area sources such as lawn maintenance equipment.

#### 3.3.1 Localized Operational Emissions – Ozone/Particulate Matter

Significance criteria have been established for criteria pollutant emissions as documented in Section 3.1. Operational emissions have been estimated for the Project using the CalEEMod Model and detailed results are included in Appendix A of this report.

Results of the CalEEMod analysis are shown in Table 8. Results indicate that the annual operational emissions from the Project will be less than the SJVAPCD emission thresholds for criteria pollutants.

**Table 8**  
**Project Operational Emissions (tons/year)**

Summary Report	CO	NO <sub>x</sub>	ROG	SO <sub>x</sub>	PM <sub>10</sub>	PM <sub>2.5</sub>	CO <sub>2e</sub>
Project Operational Emissions	1.17	0.19	0.27	0.001	0.19	0.05	279.64
SJVAPCD Level of Significance	100	10	10	27	15	15	None
Does the Project Exceed Standard?	No	No	No	No	No	No	No

Source: CalEEMod Summer Emissions

#### 3.3.2 Localized Operational Emissions

##### ✓ Carbon Monoxide

The SJVAPCD is currently in unclassified/attainment for Federal standards and attainment for State standards for CO. An analysis of localized CO concentrations is typically warranted to ensure that standards are maintained. The traffic analysis prepared for the Project demonstrates that adjacent study intersections will operate at LOS 'D' or better through the Cumulative Plus Project scenario. As a result, the overall CO concentrations at roadways and intersections in the study area would be less than significant.

### ✓ **Toxic Air Contaminants (TAC)**

The SJVAPCD's Guidance Document, Guidance for Assessing and Mitigating Air Quality Impacts – 2015, identifies the need for projects to analyze the potential for adverse air quality impacts to sensitive receptors. Sensitive receptors refer to those segments of the population most susceptible to poor air quality (i.e., children, the elderly, and those with pre-existing serious health problems affected by air quality). Land uses that have the greatest potential to attract these types of sensitive receptors include schools, parks, playgrounds, daycare centers, nursing homes, hospitals, and residential communities. From a health risk perspective, the Project is neither a Type A nor Type B project as it does not have the potential to place toxic sources in the vicinity of sensitive receptors. This is because it is a residential project of a type that would not emit significant levels of TACs and there are no potentially significant sources of TAC emissions in the vicinity.

### ✓ **Odors**

Typically, odors are regarded as an annoyance rather than a health hazard. However, manifestations of a person's reaction to foul odors can range from psychological (e.g., irritation, anger, or anxiety) to physiological (e.g., circulatory and respiratory effects, nausea, vomiting, and headache).

Quality and intensity are two properties present in any odor. The quality of an odor indicates the nature of the smell experience. For instance, if a person describes an odor as flowery or sweet, then the person is describing the quality of the odor. Intensity refers to the strength of the odor. For example, a person may use the word "strong" to describe the intensity of an odor. Odor intensity depends on the odorant concentration in the air.

When an odorous sample is progressively diluted, the odorant concentration decreases. As this occurs, the odor intensity weakens and eventually becomes so low that the detection or recognition of the odor is quite difficult. At some point during dilution, the concentration of the odorant reaches a detection threshold. An odorant concentration below the detection threshold means that the concentration in the air is not detectable by the average human.

While offensive odors rarely cause any physical harm, they can be very unpleasant, leading to considerable distress among the public and often generating citizen complaints to local governments and the SJVAPCD. Any project with the potential to frequently expose members of the public to objectionable odors should be deemed to have a significant impact.

The SJVAPCD requires that an analysis of potential odor impacts be conducted for the following two situations:

- Generators – projects that would potentially generate odorous emissions proposed to be located near existing sensitive receptors or other land uses where people may congregate, and
- Receivers – residential or other sensitive receptor projects or other projects built for the

intent of attracting people locating near existing odor sources.

The Project will not generate odorous emissions given the nature or characteristics of the Project. The intensity of an odor source's operations and its proximity to sensitive receptors influences the potential significance of odor emissions. The SJVAPCD has identified some common types of facilities that have been known to produce odors in the SJV Air Basin. The types of facilities that are known to produce odors are shown in Table 5 above along with a reasonable distance from the source within which, the degree of odors could possibly be significant. As the proposed residential project is not one that is considered to emit substantial odors during either construction or operations, no impacts would occur.

✓ **Naturally Occurring Asbestos (NOA)**

Asbestos is a term used for several types of naturally occurring fibrous minerals found in many parts of California. The most common type of asbestos is chrysotile, but other types are also found in California. Construction of the Project may cause asbestos to become airborne due to the construction activities that will occur on site. The Project would be required to submit a Dust Control Plan under the SJVAPCD's Rule 8021. Compliance with Rule 8021 would limit fugitive dust emissions from construction, demolition, excavation, extraction, and other earthmoving activities associated with the Project.

✓ **Greenhouse Gas Emissions**

CARB, in consultation with MPOs, has provided each affected region with reduction targets for GHGs emitted by passenger cars and light trucks in the region for the years 2020 and 2035. For the Fresno Council of Governments (FCOG) region, CARB set targets at five (5) percent per capita decrease in 2020 and a ten (10) percent per capita decrease in 2035 from a base year of 2005. Fresno COG's 2018 Regional Transportation Plan/Sustainable Communities Strategy (RTP/SCS) projects that the Fresno County region would achieve the prescribed emissions targets.

In 2009, the SJVAPCD adopted the following guidance documents applicable to projects within the San Joaquin Valley:

- ✓ Guidance for Valley Land-use Agencies in Addressing GHG Emission Impacts for New Projects under CEQA (SJVAPCD 2009), and
- ✓ District Policy: Addressing GHG Emission Impacts for Stationary Source Projects Under CEQA When Serving as the Lead Agency (SJVAPCD 2009).

This guidance and policy are the reference documents referenced in the SJVAPCD's Guidance for Assessing and Mitigating Air Quality Impacts adopted in March 2015 (SJVAPCD 2015). Consistent with the District Guidance and District Policy above, SJVAPCD (2015) acknowledges the current absence of numerical thresholds, and recommends a tiered approach to establish the significance of the GHG impacts on the environment:

- i. If a project complies with an approved GHG emission reduction plan or GHG mitigation

- program which avoids or substantially reduces GHG emissions within the geographic area in which the project is located, then the project would be determined to have a less than significant individual and cumulative impact for GHG emissions;
- ii. If a project does not comply with an approved GHG emission reduction plan or mitigation program, then it would be required to implement Best Performance Standards (BPS); and
  - iii. If a project is not implementing BPS, then it should demonstrate that its GHG emissions would be reduced or mitigated by at least 29 percent compared to Business as Usual (BAU).

In the event that a local air district’s guidance for addressing GHG impacts does not use numerical GHG emissions thresholds, at the lead agency’s discretion, a neighboring air district’s GHG threshold may be used to determine impacts. In December 2008, the South Coast Air Quality Management District (SCAQMD) Governing Board adopted the staff proposal for an interim GHG significance threshold for projects where the SCAQMD is lead agency. The SCAQMD guidance identifies a threshold of 3,000 MTCO<sub>2</sub>eq./year for GHG for construction emissions amortized over a 30-year project lifetime, plus annual operation emissions. This threshold is often used by agencies, such as the California Public Utilities Commission, to evaluate GHG impacts in areas that do not have specific thresholds (CPUC 2015)<sup>2</sup>. Though the Project is under SJVAPCD jurisdiction, the SCAQMD GHG threshold provides some perspective on the GHG emissions generated by the Project. Table 13 shows the yearly GHG emissions generated by the Project as determined by the CalEEMod model.

**Table 9**  
**Project Operational Greenhouse Gas Emissions**

Summary Report	CO <sub>2</sub> e
Project Operational Emissions Per Year (Plus amortized construction emissions)	303.32 MT/yr

Source: CalEEMod

---

<sup>2</sup> California Public Utilities Commission (CPUC). 2015. Section 4.7, “Greenhouse Gases.” Final Environmental Impact Report for the Santa Barbara County Reliability Project. May 2015. Accessed January 18, 2018. [http://www.cpuc.ca.gov/environment/info/ene/sbcrp/SBCRP\\_FEIR.html](http://www.cpuc.ca.gov/environment/info/ene/sbcrp/SBCRP_FEIR.html).

## 4.0 Impact Determinations and Recommended Mitigation

In accordance with CEQA, when a proposed project is consistent with a General Plan for which an EIR has been certified, the effects of that project are evaluated to determine if they will result in project-specific significant adverse impacts on the environment. The criteria used to determine the significance of an air quality or greenhouse gas impact are based on the following thresholds of significance, which come from Appendix G of the CEQA Guidelines and the General Plan EIR. Accordingly, air quality or greenhouse gas impacts resulting from the Project are considered significant if the Project would:

### Air Quality

- a) Conflict with or obstruct implementation of the applicable air quality plan?
- b) Result in a cumulatively considerable net increase of any criteria pollutant for which the project region is non-attainment under an applicable federal or state ambient air quality standard?
- c) Expose sensitive receptors to substantial pollutant concentrations?
- d) Result in other emissions such as those leading to odors adversely affecting a substantial number of people?

### Greenhouse Gas Emissions

- a) Generate greenhouse gas emissions, either directly or indirectly, that may have a significant impact on the environment?
- b) Conflict with an applicable plan, policy or regulation adopted for the purpose of reducing the emissions of greenhouse gases?

## 4.1 Air Quality

### 4.1.1 *Conflict with or obstruct implementation of the applicable air quality plan*

The primary way of determining consistency with the air quality plan's (AQP's) assumptions is determining consistency with the applicable General Plan to ensure that the Project's population density and land use are consistent with the growth assumptions used in the AQPs for the air basin.

As required by California law, city and county General Plans contain a Land Use Element that details the types and quantities of land uses that the city or county estimates will be needed for future growth, and that designate locations for land uses to regulate growth. FCOG uses the growth projections and land use information in adopted general plans to estimate future average daily trips and then VMT, which are then provided to SJVAPCD to estimate future emissions in



the AQPs. Existing and future pollutant emissions computed in the AQP are based on land uses from area general plans. AQPs detail the control measures and emission reductions required for reaching attainment of the air standards.

The applicable General Plan for the project is the County of Fresno 2000 General Plan Update. The Project is consistent with the currently adopted General Plan for the County of Fresno and is therefore consistent with the population growth and VMT applied in the plan. Therefore, the Project is consistent with the growth assumptions used in the applicable AQPs. As a result, the Project will not conflict with or obstruct implementation of any air quality plans. Therefore, no mitigation is needed.

#### ***4.1.2 Result in a cumulatively considerable net increase of any criteria pollutant for which the project region is non-attainment under an applicable federal or state ambient air quality standard***

The Fresno County area is nonattainment for Federal and State air quality standards for ozone, in attainment of Federal standards and nonattainment for State standards for PM10, and nonattainment for Federal and State standards for PM2.5. The SJVAPCD has prepared the 2016 and 2013 Ozone Plans, 2007 PM10 Maintenance Plan, and 2012 PM2.5 Plan to achieve Federal and State standards for improved air quality in the SJVAB regarding ozone and PM. Inconsistency with any of the plans would be considered a cumulatively adverse air quality impact. As discussed in Section 4.1.1, the Project is consistent with the currently adopted General Plan for the County of Fresno and is therefore consistent with the population growth and VMT applied in the plan. Therefore, the Project is consistent with the growth assumptions used in the 2016 and 2013 Ozone Plan, 2007 PM10 Maintenance Plan, and 2012 PM2.5 Plan.

Project specific emissions that exceed the thresholds of significance for criteria pollutants would be expected to result in a cumulatively considerable net increase of any criteria pollutant for which the County is in non-attainment under applicable federal or state ambient air quality standards. It should be noted that a project is not characterized as cumulatively insignificant when project emissions fall below thresholds of significance. As discussed in Section 3.1, the SJVAPCD has established thresholds of significance for determining environmental significance which are provided in Table 6.

As discussed above in Section 3.2 and 3.3, results of the analysis show that emissions generated from construction and operation of the Project will be less than the applicable SJVAPCD emission thresholds for criteria pollutants. Therefore, no mitigation is needed.

#### ***4.1.3 Expose sensitive receptors to substantial pollutant concentrations***

Sensitive receptors refer to those segments of the population most susceptible to poor air quality (i.e., children, the elderly, and those with pre-existing serious health problems affected by air quality). Land uses that have the greatest potential to attract these types of sensitive receptors

include schools, parks, playgrounds, daycare centers, nursing homes, hospitals, and residential communities. From a health risk perspective, this Project is neither Type A nor Type B as it does not propose a use known to generate significant TAC emissions nor is it near such a use that could affect future residents.

### Short-Term Impacts

The annual emissions from the construction phase of the Project will be less than the applicable SJVAPCD emission thresholds for criteria pollutants as shown in Table 7. Therefore, construction emissions associated with the Project are considered less than significant.

### Long-Term Impacts

Long-Term emissions from the Project are generated primarily by mobile source (vehicle) emissions from the Project site and area sources such as maintenance equipment. Emissions from long-term operations generally represent a project's most substantial air quality impact. Table 8 summarizes the Project's operational impacts by pollutant. Results indicate that the annual operational emissions from the Project will be less than the SJVAPCD emission thresholds for criteria pollutants. Therefore, operational emissions associated with the Project are considered less than significant.

#### ***4.1.4 Result in other emissions such as those leading to odors adversely affecting a substantial number of people***

The SJVAPCD requires that an analysis of potential odor impacts be conducted for the following two situations:

- ✓ Generators – projects that would potentially generate odorous emissions proposed to be located near existing sensitive receptors or other land uses where people may congregate, and
- ✓ Receivers – residential or other sensitive receptor projects or other projects built for the intent of attracting people located near existing odor sources.

The intensity of an odor source's operations and its proximity to sensitive receptors influences the potential significance of odor emissions. The SJVAPCD has identified some common types of facilities that have been known to produce odors in the SJV Air Basin. The types of facilities that are known to produce odors are shown in Table 5 above along with a reasonable distance from the source within which, the degree of odors could possibly be significant. The Project will not generate odorous emissions given the nature or characteristics of the Project. Therefore, no mitigation is needed.

## 4.2 Greenhouse Gas Emissions

### 4.2.1 *Generate greenhouse gas emissions, either directly or indirectly, that may have a significant impact on the environment*

The SJVAPCD acknowledges the current absence of numerical thresholds and recommends a tiered approach to establish the significance of the GHG impacts on the environment:

- i. If a project complies with an approved GHG emission reduction plan or GHG mitigation program which avoids or substantially reduces GHG emissions within the geographic area in which the project is located, then the project would be determined to have a less than significant individual and cumulative impact for GHG emissions;
- ii. If a project does not comply with an approved GHG emission reduction plan or mitigation program, then it would be required to implement Best Performance Standards (BPS); and
- iii. If a project is not implementing BPS, then it should demonstrate that its GHG emissions would be reduced or mitigated by at least 29 percent compared to Business as Usual (BAU).

In the event that a local air district's guidance for addressing GHG impacts does not use numerical GHG emissions thresholds, at the lead agency's discretion, a neighboring air district's GHG threshold may be used to determine impacts. In December 2008, the South Coast Air Quality Management District (SCAQMD) Governing Board adopted the staff proposal for an interim GHG significance threshold for projects where the SCAQMD is lead agency. The SCAQMD guidance identifies a threshold of 3,500 MTCO<sub>2</sub>eq./year for GHG for construction emissions amortized over a 30-year project lifetime, plus annual operation emissions. Though the Project is under SJVAPCD jurisdiction, the SCAQMD GHG threshold provides some perspective on the GHG emissions generated by the Project. Table 9 shows the yearly GHG emissions generated by the Project as determined by the CalEEMod model, which is less than the threshold identified by the SCAQMD.

The resulting permanent greenhouse gas increases related to Project operations would be within the greenhouse gas increases analyzed in the County of Fresno General Plan EIR since the Project meets the applicable zoning requirements. There would be no increase in severity to the greenhouse gas impacts, and implementation of the Project will not result in Project-specific or site-specific significant adverse impacts from greenhouse gas emissions within the Project study area. Therefore, no mitigation measures are needed.

### 4.2.2 *Conflict with an applicable plan, policy or regulation adopted for the purpose of reducing the emissions of greenhouse gases*

California passed the California Global Warming Solutions Act of 2006. AB 32 requires that statewide GHG emissions be reduced to 1990 levels by 2020. Under AB 32, CARB must adopt regulations by January 1, 2011, to achieve reductions in GHGs to meet the 1990 emission cap by 2020. On December 11, 2008, CARB adopted its initial Scoping Plan, which functions as a

roadmap of CARB's plans to achieve GHG reductions in California required by AB 32 through subsequently enacted regulations. CARB's 2017 Climate Change Scoping Plan builds on the efforts and plans encompassed in the initial Scoping Plan.

SB 375 requires MPOs to adopt a SCS or APS that will prescribe land use allocation in that MPO's regional transportation plan. CARB, in consultation with MPOs, has provided each affected region with reduction targets for GHGs emitted by passenger cars and light trucks in the region for the years 2020 and 2035. For the FCOG region, CARB set targets at five (5) percent per capita decrease in 2020 and a ten (10) percent per capita decrease in 2035 from a base year of 2005. FCOG's 2018 RTP/SCS projects that the Fresno County region would achieve the prescribed emissions targets.

Executive Order B-30-15 establishes a California greenhouse gas reduction target of 40 percent below 1990 levels by 2030 to ensure California meets its target of reducing greenhouse gas emissions to 80 percent below 1990 levels by 2050. Executive Order B-30-15 requires MPO's to implement measures that will achieve reductions of greenhouse gas emissions to meet the 2030 and 2050 greenhouse gas emissions reductions targets.

As required by California law, city and county General Plans contain a Land Use Element that details the types and quantities of land uses that the city or county estimates will be needed for future growth, and that designate locations for land uses to regulate growth. FCOG uses the growth projections and land use information in adopted general plans to estimate future average daily trips and then VMT, which are then provided to SJVAPCD to estimate future emissions in the AQPs. The applicable General Plan for the project is County of Fresno 2000 General Plan Update.

The Project is consistent with the currently adopted General Plan for the County of Fresno and the adopted FCOG 2018 RTP/SCS and is therefore consistent with the population growth and VMT applied in those plan documents. Therefore, the Project is consistent with the growth assumptions used in the applicable AQP. It should also be noted that yearly GHG emissions generated by the Project (Table 9) are less than the threshold identified by the SCAQMD (see the discussion for Impact 4.2.1 above).

CARB's 2017 Climate Change Scoping Plan builds on the efforts and plans encompassed in the initial Scoping Plan. The current plan has identified new policies and actions to accomplish the State's 2030 GHG limit. Below is a list of applicable strategies in the Scoping Plan and the Project's consistency with those strategies.

- ✓ California Light-Duty Vehicle GHG Standards – Implement adopted standards and planned second phase of the program. Align zero-emission vehicle, alternative and renewable fuel and vehicle technology programs for long-term climate change goals.
  - The Project is consistent with this reduction measure. This measure cannot be implemented by a particular project or lead agency since it is a statewide measure. When

this measure is implemented, standards would be applicable to light-duty vehicles that would access the Project. The Project would not conflict or obstruct this reduction measure.

- ✓ Energy Efficiency – Pursuit of comparable investment in energy efficiency from all retail providers of electricity in California. Maximize energy efficiency building and appliance standards.
  - The Project is consistent with this reduction measure. Though this measure applies to the State to increase its energy standards, the Project would comply with this measure through existing regulation. The Project would not conflict or obstruct this reduction measure.
- ✓ Low Carbon Fuel – Development and adoption of the low carbon fuel standard.
  - The Project is consistent with this reduction measure. This measure cannot be implemented by a particular project or lead agency since it is a statewide measure. When this measure is implemented, standards would be applicable to the fuel used by vehicles that would access the Project. The Project would not conflict or obstruct this reduction measure.

Based on the assessment above, the Project will not conflict with an applicable plan, policy or regulation adopted for the purpose of reducing the emissions of greenhouse gases. Therefore, any impacts would be less than significant.

This Page is intentionally left blank.



# **Appendix- A**

## CaIEEMOD Worksheets

Fresno County 18-Unit SFR Project - San Joaquin Valley Unified APCD Air District, Annual

**EMFAC Off-Model Adjustment Factors for Gasoline Light Duty Vehicle to Account for the SAFE Vehicle Rule Not Applied**

**Fresno County 18-Unit SFR Project**  
**San Joaquin Valley Unified APCD Air District, Annual**

**1.0 Project Characteristics**

---

**1.1 Land Usage**

Land Uses	Size	Metric	Lot Acreage	Floor Surface Area	Population
Single Family Housing	18.00	Dwelling Unit	5.84	32,400.00	57

**1.2 Other Project Characteristics**

<b>Urbanization</b>	Urban	<b>Wind Speed (m/s)</b>	2.7	<b>Precipitation Freq (Days)</b>	45
<b>Climate Zone</b>	7			<b>Operational Year</b>	2024
<b>Utility Company</b>	Pacific Gas and Electric Company				
<b>CO2 Intensity (lb/MWhr)</b>	203.98	<b>CH4 Intensity (lb/MWhr)</b>	0.033	<b>N2O Intensity (lb/MWhr)</b>	0.004

**1.3 User Entered Comments & Non-Default Data**

Project Characteristics -

Land Use -

Construction Off-road Equipment Mitigation -

Table Name	Column Name	Default Value	New Value
tblWoodstoves	NumberCatalytic	5.84	0.00
tblWoodstoves	NumberNoncatalytic	5.84	0.00

**2.0 Emissions Summary**

---

Fresno County 18-Unit SFR Project - San Joaquin Valley Unified APCD Air District, Annual

**EMFAC Off-Model Adjustment Factors for Gasoline Light Duty Vehicle to Account for the SAFE Vehicle Rule Not Applied**

**2.1 Overall Construction**

**Unmitigated Construction**

	ROG	NOx	CO	SO2	Fugitive PM10	Exhaust PM10	PM10 Total	Fugitive PM2.5	Exhaust PM2.5	PM2.5 Total	Bio- CO2	NBio- CO2	Total CO2	CH4	N2O	CO2e
Year	tons/yr										MT/yr					
2022	0.1332	1.2696	1.1384	2.0300e-003	0.1747	0.0627	0.2375	0.0863	0.0585	0.1448	0.0000	176.4215	176.4215	0.0460	3.7000e-004	177.6833
2023	0.4356	1.1945	1.3912	2.3400e-003	5.8400e-003	0.0580	0.0639	1.5800e-003	0.0545	0.0561	0.0000	202.0362	202.0362	0.0479	5.5000e-004	203.3948
<b>Maximum</b>	<b>0.4356</b>	<b>1.2696</b>	<b>1.3912</b>	<b>2.3400e-003</b>	<b>0.1747</b>	<b>0.0627</b>	<b>0.2375</b>	<b>0.0863</b>	<b>0.0585</b>	<b>0.1448</b>	<b>0.0000</b>	<b>202.0362</b>	<b>202.0362</b>	<b>0.0479</b>	<b>5.5000e-004</b>	<b>203.3948</b>

**Mitigated Construction**

	ROG	NOx	CO	SO2	Fugitive PM10	Exhaust PM10	PM10 Total	Fugitive PM2.5	Exhaust PM2.5	PM2.5 Total	Bio- CO2	NBio- CO2	Total CO2	CH4	N2O	CO2e
Year	tons/yr										MT/yr					
2022	0.1332	1.2696	1.1384	2.0300e-003	0.0779	0.0627	0.1406	0.0377	0.0585	0.0963	0.0000	176.4213	176.4213	0.0460	3.7000e-004	177.6831
2023	0.4356	1.1945	1.3912	2.3400e-003	5.8400e-003	0.0580	0.0639	1.5800e-003	0.0545	0.0561	0.0000	202.0359	202.0359	0.0479	5.5000e-004	203.3946
<b>Maximum</b>	<b>0.4356</b>	<b>1.2696</b>	<b>1.3912</b>	<b>2.3400e-003</b>	<b>0.0779</b>	<b>0.0627</b>	<b>0.1406</b>	<b>0.0377</b>	<b>0.0585</b>	<b>0.0963</b>	<b>0.0000</b>	<b>202.0359</b>	<b>202.0359</b>	<b>0.0479</b>	<b>5.5000e-004</b>	<b>203.3946</b>

Fresno County 18-Unit SFR Project - San Joaquin Valley Unified APCD Air District, Annual

**EMFAC Off-Model Adjustment Factors for Gasoline Light Duty Vehicle to Account for the SAFE Vehicle Rule Not Applied**

	ROG	NOx	CO	SO2	Fugitive PM10	Exhaust PM10	PM10 Total	Fugitive PM2.5	Exhaust PM2.5	PM2.5 Total	Bio- CO2	NBio-CO2	Total CO2	CH4	N2O	CO2e
Percent Reduction	0.00	0.00	0.00	0.00	53.63	0.00	32.13	55.25	0.00	24.16	0.00	0.00	0.00	0.00	0.00	0.00

Quarter	Start Date	End Date	Maximum Unmitigated ROG + NOX (tons/quarter)	Maximum Mitigated ROG + NOX (tons/quarter)
1	7-1-2022	9-30-2022	0.8326	0.8326
2	10-1-2022	12-31-2022	0.5742	0.5742
3	1-1-2023	3-31-2023	0.5170	0.5170
4	4-1-2023	6-30-2023	0.5225	0.5225
5	7-1-2023	9-30-2023	0.5872	0.5872
		Highest	0.8326	0.8326

**2.2 Overall Operational**

**Unmitigated Operational**

	ROG	NOx	CO	SO2	Fugitive PM10	Exhaust PM10	PM10 Total	Fugitive PM2.5	Exhaust PM2.5	PM2.5 Total	Bio- CO2	NBio- CO2	Total CO2	CH4	N2O	CO2e
Category	tons/yr										MT/yr					
Area	0.1618	8.2700e-003	0.1365	5.0000e-005		1.2800e-003	1.2800e-003		1.2800e-003	1.2800e-003	0.0000	8.0161	8.0161	3.6000e-004	1.4000e-004	8.0676
Energy	2.3100e-003	0.0197	8.3900e-003	1.3000e-004		1.5900e-003	1.5900e-003		1.5900e-003	1.5900e-003	0.0000	36.0473	36.0473	2.5800e-003	6.8000e-004	36.3137
Mobile	0.0849	0.1517	0.7980	1.9100e-003	0.1826	1.7100e-003	0.1843	0.0489	1.6000e-003	0.0505	0.0000	176.3750	176.3750	9.3800e-003	9.9900e-003	179.5870
Waste						0.0000	0.0000		0.0000	0.0000	4.3542	0.0000	4.3542	0.2573	0.0000	10.7872
Water						0.0000	0.0000		0.0000	0.0000	0.3721	0.8266	1.1986	0.0384	9.2000e-004	2.4311
<b>Total</b>	<b>0.2489</b>	<b>0.1797</b>	<b>0.9428</b>	<b>2.0900e-003</b>	<b>0.1826</b>	<b>4.5800e-003</b>	<b>0.1872</b>	<b>0.0489</b>	<b>4.4700e-003</b>	<b>0.0533</b>	<b>4.7262</b>	<b>221.2649</b>	<b>225.9911</b>	<b>0.3080</b>	<b>0.0117</b>	<b>237.1866</b>

Fresno County 18-Unit SFR Project - San Joaquin Valley Unified APCD Air District, Annual

**EMFAC Off-Model Adjustment Factors for Gasoline Light Duty Vehicle to Account for the SAFE Vehicle Rule Not Applied**

**2.2 Overall Operational**

**Mitigated Operational**

	ROG	NOx	CO	SO2	Fugitive PM10	Exhaust PM10	PM10 Total	Fugitive PM2.5	Exhaust PM2.5	PM2.5 Total	Bio- CO2	NBio- CO2	Total CO2	CH4	N2O	CO2e
Category	tons/yr										MT/yr					
Area	0.1618	8.2700e-003	0.1365	5.0000e-005		1.2800e-003	1.2800e-003		1.2800e-003	1.2800e-003	0.0000	8.0161	8.0161	3.6000e-004	1.4000e-004	8.0676
Energy	2.3100e-003	0.0197	8.3900e-003	1.3000e-004		1.5900e-003	1.5900e-003		1.5900e-003	1.5900e-003	0.0000	36.0473	36.0473	2.5800e-003	6.8000e-004	36.3137
Mobile	0.0849	0.1517	0.7980	1.9100e-003	0.1826	1.7100e-003	0.1843	0.0489	1.6000e-003	0.0505	0.0000	176.3750	176.3750	9.3800e-003	9.9900e-003	179.5870
Waste						0.0000	0.0000		0.0000	0.0000	4.3542	0.0000	4.3542	0.2573	0.0000	10.7872
Water						0.0000	0.0000		0.0000	0.0000	0.3721	0.8266	1.1986	0.0384	9.2000e-004	2.4311
<b>Total</b>	<b>0.2489</b>	<b>0.1797</b>	<b>0.9428</b>	<b>2.0900e-003</b>	<b>0.1826</b>	<b>4.5800e-003</b>	<b>0.1872</b>	<b>0.0489</b>	<b>4.4700e-003</b>	<b>0.0533</b>	<b>4.7262</b>	<b>221.2649</b>	<b>225.9911</b>	<b>0.3080</b>	<b>0.0117</b>	<b>237.1866</b>

	ROG	NOx	CO	SO2	Fugitive PM10	Exhaust PM10	PM10 Total	Fugitive PM2.5	Exhaust PM2.5	PM2.5 Total	Bio- CO2	NBio- CO2	Total CO2	CH4	N2O	CO2e
<b>Percent Reduction</b>	<b>0.00</b>	<b>0.00</b>	<b>0.00</b>	<b>0.00</b>	<b>0.00</b>	<b>0.00</b>	<b>0.00</b>	<b>0.00</b>	<b>0.00</b>	<b>0.00</b>	<b>0.00</b>	<b>0.00</b>	<b>0.00</b>	<b>0.00</b>	<b>0.00</b>	<b>0.00</b>

**3.0 Construction Detail**

**Construction Phase**

Phase Number	Phase Name	Phase Type	Start Date	End Date	Num Days Week	Num Days	Phase Description
1	Demolition	Demolition	7/1/2022	7/28/2022	5	20	
2	Site Preparation	Site Preparation	7/29/2022	8/11/2022	5	10	
3	Grading	Grading	8/12/2022	9/8/2022	5	20	



Fresno County 18-Unit SFR Project - San Joaquin Valley Unified APCD Air District, Annual

**EMFAC Off-Model Adjustment Factors for Gasoline Light Duty Vehicle to Account for the SAFE Vehicle Rule Not Applied**

4	Building Construction	Building Construction	9/9/2022	7/27/2023	5	230
5	Paving	Paving	7/28/2023	8/24/2023	5	20
6	Architectural Coating	Architectural Coating	8/25/2023	9/21/2023	5	20

**Acres of Grading (Site Preparation Phase): 15**

**Acres of Grading (Grading Phase): 20**

**Acres of Paving: 0**

**Residential Indoor: 65,610; Residential Outdoor: 21,870; Non-Residential Indoor: 0; Non-Residential Outdoor: 0; Striped Parking Area: 0 (Architectural Coating – sqft)**

**OffRoad Equipment**

Phase Name	Offroad Equipment Type	Amount	Usage Hours	Horse Power	Load Factor
Architectural Coating	Air Compressors	1	6.00	78	0.48
Demolition	Concrete/Industrial Saws	1	8.00	81	0.73
Building Construction	Cranes	1	7.00	231	0.29
Demolition	Excavators	3	8.00	158	0.38
Grading	Excavators	1	8.00	158	0.38
Building Construction	Forklifts	3	8.00	89	0.20
Building Construction	Generator Sets	1	8.00	84	0.74
Grading	Graders	1	8.00	187	0.41
Paving	Pavers	2	8.00	130	0.42
Paving	Paving Equipment	2	8.00	132	0.36
Paving	Rollers	2	8.00	80	0.38
Demolition	Rubber Tired Dozers	2	8.00	247	0.40
Grading	Rubber Tired Dozers	1	8.00	247	0.40
Site Preparation	Rubber Tired Dozers	3	8.00	247	0.40
Building Construction	Tractors/Loaders/Backhoes	3	7.00	97	0.37
Grading	Tractors/Loaders/Backhoes	3	8.00	97	0.37
Site Preparation	Tractors/Loaders/Backhoes	4	8.00	97	0.37

Fresno County 18-Unit SFR Project - San Joaquin Valley Unified APCD Air District, Annual

**EMFAC Off-Model Adjustment Factors for Gasoline Light Duty Vehicle to Account for the SAFE Vehicle Rule Not Applied**

Building Construction	Welders	1	8.00	46	0.45
-----------------------	---------	---	------	----	------

**Trips and VMT**

Phase Name	Offroad Equipment Count	Worker Trip Number	Vendor Trip Number	Hauling Trip Number	Worker Trip Length	Vendor Trip Length	Hauling Trip Length	Worker Vehicle Class	Vendor Vehicle Class	Hauling Vehicle Class
Demolition	6	15.00	0.00	0.00	10.80	7.30	20.00	LD_Mix	HDT_Mix	HHDT
Site Preparation	7	18.00	0.00	0.00	10.80	7.30	20.00	LD_Mix	HDT_Mix	HHDT
Grading	6	15.00	0.00	0.00	10.80	7.30	20.00	LD_Mix	HDT_Mix	HHDT
Building Construction	9	6.00	2.00	0.00	10.80	7.30	20.00	LD_Mix	HDT_Mix	HHDT
Paving	6	15.00	0.00	0.00	10.80	7.30	20.00	LD_Mix	HDT_Mix	HHDT
Architectural Coating	1	1.00	0.00	0.00	10.80	7.30	20.00	LD_Mix	HDT_Mix	HHDT

**3.1 Mitigation Measures Construction**

- Use Soil Stabilizer
- Replace Ground Cover
- Water Exposed Area

**3.2 Demolition - 2022**

**Unmitigated Construction On-Site**

	ROG	NOx	CO	SO2	Fugitive PM10	Exhaust PM10	PM10 Total	Fugitive PM2.5	Exhaust PM2.5	PM2.5 Total	Bio- CO2	NBio- CO2	Total CO2	CH4	N2O	CO2e
Category	tons/yr										MT/yr					
Off-Road	0.0264	0.2572	0.2059	3.9000e-004		0.0124	0.0124		0.0116	0.0116	0.0000	33.9902	33.9902	9.5500e-003	0.0000	34.2289
<b>Total</b>	<b>0.0264</b>	<b>0.2572</b>	<b>0.2059</b>	<b>3.9000e-004</b>		<b>0.0124</b>	<b>0.0124</b>		<b>0.0116</b>	<b>0.0116</b>	<b>0.0000</b>	<b>33.9902</b>	<b>33.9902</b>	<b>9.5500e-003</b>	<b>0.0000</b>	<b>34.2289</b>

Fresno County 18-Unit SFR Project - San Joaquin Valley Unified APCD Air District, Annual

**EMFAC Off-Model Adjustment Factors for Gasoline Light Duty Vehicle to Account for the SAFE Vehicle Rule Not Applied**

**3.2 Demolition - 2022**

**Unmitigated Construction Off-Site**

	ROG	NOx	CO	SO2	Fugitive PM10	Exhaust PM10	PM10 Total	Fugitive PM2.5	Exhaust PM2.5	PM2.5 Total	Bio- CO2	NBio- CO2	Total CO2	CH4	N2O	CO2e
Category	tons/yr										MT/yr					
Hauling	0.0000	0.0000	0.0000	0.0000	0.0000	0.0000	0.0000	0.0000	0.0000	0.0000	0.0000	0.0000	0.0000	0.0000	0.0000	0.0000
Vendor	0.0000	0.0000	0.0000	0.0000	0.0000	0.0000	0.0000	0.0000	0.0000	0.0000	0.0000	0.0000	0.0000	0.0000	0.0000	0.0000
Worker	5.1000e-004	3.6000e-004	4.0800e-003	1.0000e-005	1.2000e-003	1.0000e-005	1.2100e-003	3.2000e-004	1.0000e-005	3.2000e-004	0.0000	0.9909	0.9909	3.0000e-005	3.0000e-005	1.0009
<b>Total</b>	<b>5.1000e-004</b>	<b>3.6000e-004</b>	<b>4.0800e-003</b>	<b>1.0000e-005</b>	<b>1.2000e-003</b>	<b>1.0000e-005</b>	<b>1.2100e-003</b>	<b>3.2000e-004</b>	<b>1.0000e-005</b>	<b>3.2000e-004</b>	<b>0.0000</b>	<b>0.9909</b>	<b>0.9909</b>	<b>3.0000e-005</b>	<b>3.0000e-005</b>	<b>1.0009</b>

**Mitigated Construction On-Site**

	ROG	NOx	CO	SO2	Fugitive PM10	Exhaust PM10	PM10 Total	Fugitive PM2.5	Exhaust PM2.5	PM2.5 Total	Bio- CO2	NBio- CO2	Total CO2	CH4	N2O	CO2e
Category	tons/yr										MT/yr					
Off-Road	0.0264	0.2572	0.2059	3.9000e-004		0.0124	0.0124		0.0116	0.0116	0.0000	33.9902	33.9902	9.5500e-003	0.0000	34.2289
<b>Total</b>	<b>0.0264</b>	<b>0.2572</b>	<b>0.2059</b>	<b>3.9000e-004</b>		<b>0.0124</b>	<b>0.0124</b>		<b>0.0116</b>	<b>0.0116</b>	<b>0.0000</b>	<b>33.9902</b>	<b>33.9902</b>	<b>9.5500e-003</b>	<b>0.0000</b>	<b>34.2289</b>

Fresno County 18-Unit SFR Project - San Joaquin Valley Unified APCD Air District, Annual

**EMFAC Off-Model Adjustment Factors for Gasoline Light Duty Vehicle to Account for the SAFE Vehicle Rule Not Applied**

**3.2 Demolition - 2022**

**Mitigated Construction Off-Site**

	ROG	NOx	CO	SO2	Fugitive PM10	Exhaust PM10	PM10 Total	Fugitive PM2.5	Exhaust PM2.5	PM2.5 Total	Bio- CO2	NBio- CO2	Total CO2	CH4	N2O	CO2e
Category	tons/yr										MT/yr					
Hauling	0.0000	0.0000	0.0000	0.0000	0.0000	0.0000	0.0000	0.0000	0.0000	0.0000	0.0000	0.0000	0.0000	0.0000	0.0000	0.0000
Vendor	0.0000	0.0000	0.0000	0.0000	0.0000	0.0000	0.0000	0.0000	0.0000	0.0000	0.0000	0.0000	0.0000	0.0000	0.0000	0.0000
Worker	5.1000e-004	3.6000e-004	4.0800e-003	1.0000e-005	1.2000e-003	1.0000e-005	1.2100e-003	3.2000e-004	1.0000e-005	3.2000e-004	0.0000	0.9909	0.9909	3.0000e-005	3.0000e-005	1.0009
<b>Total</b>	<b>5.1000e-004</b>	<b>3.6000e-004</b>	<b>4.0800e-003</b>	<b>1.0000e-005</b>	<b>1.2000e-003</b>	<b>1.0000e-005</b>	<b>1.2100e-003</b>	<b>3.2000e-004</b>	<b>1.0000e-005</b>	<b>3.2000e-004</b>	<b>0.0000</b>	<b>0.9909</b>	<b>0.9909</b>	<b>3.0000e-005</b>	<b>3.0000e-005</b>	<b>1.0009</b>

**3.3 Site Preparation - 2022**

**Unmitigated Construction On-Site**

	ROG	NOx	CO	SO2	Fugitive PM10	Exhaust PM10	PM10 Total	Fugitive PM2.5	Exhaust PM2.5	PM2.5 Total	Bio- CO2	NBio- CO2	Total CO2	CH4	N2O	CO2e
Category	tons/yr										MT/yr					
Fugitive Dust					0.0983	0.0000	0.0983	0.0505	0.0000	0.0505	0.0000	0.0000	0.0000	0.0000	0.0000	0.0000
Off-Road	0.0159	0.1654	0.0985	1.9000e-004		8.0600e-003	8.0600e-003		7.4200e-003	7.4200e-003	0.0000	16.7197	16.7197	5.4100e-003	0.0000	16.8549
<b>Total</b>	<b>0.0159</b>	<b>0.1654</b>	<b>0.0985</b>	<b>1.9000e-004</b>	<b>0.0983</b>	<b>8.0600e-003</b>	<b>0.1064</b>	<b>0.0505</b>	<b>7.4200e-003</b>	<b>0.0579</b>	<b>0.0000</b>	<b>16.7197</b>	<b>16.7197</b>	<b>5.4100e-003</b>	<b>0.0000</b>	<b>16.8549</b>

Fresno County 18-Unit SFR Project - San Joaquin Valley Unified APCD Air District, Annual

**EMFAC Off-Model Adjustment Factors for Gasoline Light Duty Vehicle to Account for the SAFE Vehicle Rule Not Applied**

**3.3 Site Preparation - 2022**

**Unmitigated Construction Off-Site**

	ROG	NOx	CO	SO2	Fugitive PM10	Exhaust PM10	PM10 Total	Fugitive PM2.5	Exhaust PM2.5	PM2.5 Total	Bio- CO2	NBio- CO2	Total CO2	CH4	N2O	CO2e
Category	tons/yr										MT/yr					
Hauling	0.0000	0.0000	0.0000	0.0000	0.0000	0.0000	0.0000	0.0000	0.0000	0.0000	0.0000	0.0000	0.0000	0.0000	0.0000	0.0000
Vendor	0.0000	0.0000	0.0000	0.0000	0.0000	0.0000	0.0000	0.0000	0.0000	0.0000	0.0000	0.0000	0.0000	0.0000	0.0000	0.0000
Worker	3.1000e-004	2.2000e-004	2.4500e-003	1.0000e-005	7.2000e-004	0.0000	7.2000e-004	1.9000e-004	0.0000	1.9000e-004	0.0000	0.5945	0.5945	2.0000e-005	2.0000e-005	0.6006
<b>Total</b>	<b>3.1000e-004</b>	<b>2.2000e-004</b>	<b>2.4500e-003</b>	<b>1.0000e-005</b>	<b>7.2000e-004</b>	<b>0.0000</b>	<b>7.2000e-004</b>	<b>1.9000e-004</b>	<b>0.0000</b>	<b>1.9000e-004</b>	<b>0.0000</b>	<b>0.5945</b>	<b>0.5945</b>	<b>2.0000e-005</b>	<b>2.0000e-005</b>	<b>0.6006</b>

**Mitigated Construction On-Site**

	ROG	NOx	CO	SO2	Fugitive PM10	Exhaust PM10	PM10 Total	Fugitive PM2.5	Exhaust PM2.5	PM2.5 Total	Bio- CO2	NBio- CO2	Total CO2	CH4	N2O	CO2e
Category	tons/yr										MT/yr					
Fugitive Dust					0.0420	0.0000	0.0420	0.0216	0.0000	0.0216	0.0000	0.0000	0.0000	0.0000	0.0000	0.0000
Off-Road	0.0159	0.1654	0.0985	1.9000e-004		8.0600e-003	8.0600e-003		7.4200e-003	7.4200e-003	0.0000	16.7197	16.7197	5.4100e-003	0.0000	16.8549
<b>Total</b>	<b>0.0159</b>	<b>0.1654</b>	<b>0.0985</b>	<b>1.9000e-004</b>	<b>0.0420</b>	<b>8.0600e-003</b>	<b>0.0501</b>	<b>0.0216</b>	<b>7.4200e-003</b>	<b>0.0290</b>	<b>0.0000</b>	<b>16.7197</b>	<b>16.7197</b>	<b>5.4100e-003</b>	<b>0.0000</b>	<b>16.8549</b>



Fresno County 18-Unit SFR Project - San Joaquin Valley Unified APCD Air District, Annual

**EMFAC Off-Model Adjustment Factors for Gasoline Light Duty Vehicle to Account for the SAFE Vehicle Rule Not Applied**

**3.3 Site Preparation - 2022**

**Mitigated Construction Off-Site**

	ROG	NOx	CO	SO2	Fugitive PM10	Exhaust PM10	PM10 Total	Fugitive PM2.5	Exhaust PM2.5	PM2.5 Total	Bio- CO2	NBio- CO2	Total CO2	CH4	N2O	CO2e
Category	tons/yr										MT/yr					
Hauling	0.0000	0.0000	0.0000	0.0000	0.0000	0.0000	0.0000	0.0000	0.0000	0.0000	0.0000	0.0000	0.0000	0.0000	0.0000	0.0000
Vendor	0.0000	0.0000	0.0000	0.0000	0.0000	0.0000	0.0000	0.0000	0.0000	0.0000	0.0000	0.0000	0.0000	0.0000	0.0000	0.0000
Worker	3.1000e-004	2.2000e-004	2.4500e-003	1.0000e-005	7.2000e-004	0.0000	7.2000e-004	1.9000e-004	0.0000	1.9000e-004	0.0000	0.5945	0.5945	2.0000e-005	2.0000e-005	0.6006
<b>Total</b>	<b>3.1000e-004</b>	<b>2.2000e-004</b>	<b>2.4500e-003</b>	<b>1.0000e-005</b>	<b>7.2000e-004</b>	<b>0.0000</b>	<b>7.2000e-004</b>	<b>1.9000e-004</b>	<b>0.0000</b>	<b>1.9000e-004</b>	<b>0.0000</b>	<b>0.5945</b>	<b>0.5945</b>	<b>2.0000e-005</b>	<b>2.0000e-005</b>	<b>0.6006</b>

**3.4 Grading - 2022**

**Unmitigated Construction On-Site**

	ROG	NOx	CO	SO2	Fugitive PM10	Exhaust PM10	PM10 Total	Fugitive PM2.5	Exhaust PM2.5	PM2.5 Total	Bio- CO2	NBio- CO2	Total CO2	CH4	N2O	CO2e
Category	tons/yr										MT/yr					
Fugitive Dust					0.0708	0.0000	0.0708	0.0343	0.0000	0.0343	0.0000	0.0000	0.0000	0.0000	0.0000	0.0000
Off-Road	0.0195	0.2086	0.1527	3.0000e-004		9.4100e-003	9.4100e-003		8.6600e-003	8.6600e-003	0.0000	26.0548	26.0548	8.4300e-003	0.0000	26.2654
<b>Total</b>	<b>0.0195</b>	<b>0.2086</b>	<b>0.1527</b>	<b>3.0000e-004</b>	<b>0.0708</b>	<b>9.4100e-003</b>	<b>0.0802</b>	<b>0.0343</b>	<b>8.6600e-003</b>	<b>0.0429</b>	<b>0.0000</b>	<b>26.0548</b>	<b>26.0548</b>	<b>8.4300e-003</b>	<b>0.0000</b>	<b>26.2654</b>

Fresno County 18-Unit SFR Project - San Joaquin Valley Unified APCD Air District, Annual

**EMFAC Off-Model Adjustment Factors for Gasoline Light Duty Vehicle to Account for the SAFE Vehicle Rule Not Applied**

**3.4 Grading - 2022**

**Unmitigated Construction Off-Site**

	ROG	NOx	CO	SO2	Fugitive PM10	Exhaust PM10	PM10 Total	Fugitive PM2.5	Exhaust PM2.5	PM2.5 Total	Bio- CO2	NBio- CO2	Total CO2	CH4	N2O	CO2e
Category	tons/yr										MT/yr					
Hauling	0.0000	0.0000	0.0000	0.0000	0.0000	0.0000	0.0000	0.0000	0.0000	0.0000	0.0000	0.0000	0.0000	0.0000	0.0000	0.0000
Vendor	0.0000	0.0000	0.0000	0.0000	0.0000	0.0000	0.0000	0.0000	0.0000	0.0000	0.0000	0.0000	0.0000	0.0000	0.0000	0.0000
Worker	5.1000e-004	3.6000e-004	4.0800e-003	1.0000e-005	1.2000e-003	1.0000e-005	1.2100e-003	3.2000e-004	1.0000e-005	3.2000e-004	0.0000	0.9909	0.9909	3.0000e-005	3.0000e-005	1.0009
<b>Total</b>	<b>5.1000e-004</b>	<b>3.6000e-004</b>	<b>4.0800e-003</b>	<b>1.0000e-005</b>	<b>1.2000e-003</b>	<b>1.0000e-005</b>	<b>1.2100e-003</b>	<b>3.2000e-004</b>	<b>1.0000e-005</b>	<b>3.2000e-004</b>	<b>0.0000</b>	<b>0.9909</b>	<b>0.9909</b>	<b>3.0000e-005</b>	<b>3.0000e-005</b>	<b>1.0009</b>

**Mitigated Construction On-Site**

	ROG	NOx	CO	SO2	Fugitive PM10	Exhaust PM10	PM10 Total	Fugitive PM2.5	Exhaust PM2.5	PM2.5 Total	Bio- CO2	NBio- CO2	Total CO2	CH4	N2O	CO2e
Category	tons/yr										MT/yr					
Fugitive Dust					0.0303	0.0000	0.0303	0.0146	0.0000	0.0146	0.0000	0.0000	0.0000	0.0000	0.0000	0.0000
Off-Road	0.0195	0.2086	0.1527	3.0000e-004		9.4100e-003	9.4100e-003		8.6600e-003	8.6600e-003	0.0000	26.0547	26.0547	8.4300e-003	0.0000	26.2654
<b>Total</b>	<b>0.0195</b>	<b>0.2086</b>	<b>0.1527</b>	<b>3.0000e-004</b>	<b>0.0303</b>	<b>9.4100e-003</b>	<b>0.0397</b>	<b>0.0146</b>	<b>8.6600e-003</b>	<b>0.0233</b>	<b>0.0000</b>	<b>26.0547</b>	<b>26.0547</b>	<b>8.4300e-003</b>	<b>0.0000</b>	<b>26.2654</b>

Fresno County 18-Unit SFR Project - San Joaquin Valley Unified APCD Air District, Annual

**EMFAC Off-Model Adjustment Factors for Gasoline Light Duty Vehicle to Account for the SAFE Vehicle Rule Not Applied**

**3.4 Grading - 2022**

**Mitigated Construction Off-Site**

	ROG	NOx	CO	SO2	Fugitive PM10	Exhaust PM10	PM10 Total	Fugitive PM2.5	Exhaust PM2.5	PM2.5 Total	Bio- CO2	NBio- CO2	Total CO2	CH4	N2O	CO2e
Category	tons/yr										MT/yr					
Hauling	0.0000	0.0000	0.0000	0.0000	0.0000	0.0000	0.0000	0.0000	0.0000	0.0000	0.0000	0.0000	0.0000	0.0000	0.0000	0.0000
Vendor	0.0000	0.0000	0.0000	0.0000	0.0000	0.0000	0.0000	0.0000	0.0000	0.0000	0.0000	0.0000	0.0000	0.0000	0.0000	0.0000
Worker	5.1000e-004	3.6000e-004	4.0800e-003	1.0000e-005	1.2000e-003	1.0000e-005	1.2100e-003	3.2000e-004	1.0000e-005	3.2000e-004	0.0000	0.9909	0.9909	3.0000e-005	3.0000e-005	1.0009
<b>Total</b>	<b>5.1000e-004</b>	<b>3.6000e-004</b>	<b>4.0800e-003</b>	<b>1.0000e-005</b>	<b>1.2000e-003</b>	<b>1.0000e-005</b>	<b>1.2100e-003</b>	<b>3.2000e-004</b>	<b>1.0000e-005</b>	<b>3.2000e-004</b>	<b>0.0000</b>	<b>0.9909</b>	<b>0.9909</b>	<b>3.0000e-005</b>	<b>3.0000e-005</b>	<b>1.0009</b>

**3.5 Building Construction - 2022**

**Unmitigated Construction On-Site**

	ROG	NOx	CO	SO2	Fugitive PM10	Exhaust PM10	PM10 Total	Fugitive PM2.5	Exhaust PM2.5	PM2.5 Total	Bio- CO2	NBio- CO2	Total CO2	CH4	N2O	CO2e
Category	tons/yr										MT/yr					
Off-Road	0.0691	0.6324	0.6627	1.0900e-003		0.0328	0.0328		0.0308	0.0308	0.0000	93.8487	93.8487	0.0225	0.0000	94.4108
<b>Total</b>	<b>0.0691</b>	<b>0.6324</b>	<b>0.6627</b>	<b>1.0900e-003</b>		<b>0.0328</b>	<b>0.0328</b>		<b>0.0308</b>	<b>0.0308</b>	<b>0.0000</b>	<b>93.8487</b>	<b>93.8487</b>	<b>0.0225</b>	<b>0.0000</b>	<b>94.4108</b>

Fresno County 18-Unit SFR Project - San Joaquin Valley Unified APCD Air District, Annual

**EMFAC Off-Model Adjustment Factors for Gasoline Light Duty Vehicle to Account for the SAFE Vehicle Rule Not Applied**

**3.5 Building Construction - 2022**

**Unmitigated Construction Off-Site**

	ROG	NOx	CO	SO2	Fugitive PM10	Exhaust PM10	PM10 Total	Fugitive PM2.5	Exhaust PM2.5	PM2.5 Total	Bio- CO2	NBio- CO2	Total CO2	CH4	N2O	CO2e
Category	tons/yr										MT/yr					
Hauling	0.0000	0.0000	0.0000	0.0000	0.0000	0.0000	0.0000	0.0000	0.0000	0.0000	0.0000	0.0000	0.0000	0.0000	0.0000	0.0000
Vendor	1.8000e-004	4.4500e-003	1.2800e-003	2.0000e-005	5.4000e-004	5.0000e-005	5.9000e-004	1.6000e-004	5.0000e-005	2.0000e-004	0.0000	1.6265	1.6265	1.0000e-005	2.4000e-004	1.6994
Worker	8.3000e-004	5.9000e-004	6.6200e-003	2.0000e-005	1.9400e-003	1.0000e-005	1.9500e-003	5.2000e-004	1.0000e-005	5.3000e-004	0.0000	1.6052	1.6052	5.0000e-005	5.0000e-005	1.6215
<b>Total</b>	<b>1.0100e-003</b>	<b>5.0400e-003</b>	<b>7.9000e-003</b>	<b>4.0000e-005</b>	<b>2.4800e-003</b>	<b>6.0000e-005</b>	<b>2.5400e-003</b>	<b>6.8000e-004</b>	<b>6.0000e-005</b>	<b>7.3000e-004</b>	<b>0.0000</b>	<b>3.2318</b>	<b>3.2318</b>	<b>6.0000e-005</b>	<b>2.9000e-004</b>	<b>3.3209</b>

**Mitigated Construction On-Site**

	ROG	NOx	CO	SO2	Fugitive PM10	Exhaust PM10	PM10 Total	Fugitive PM2.5	Exhaust PM2.5	PM2.5 Total	Bio- CO2	NBio- CO2	Total CO2	CH4	N2O	CO2e
Category	tons/yr										MT/yr					
Off-Road	0.0691	0.6324	0.6627	1.0900e-003		0.0328	0.0328		0.0308	0.0308	0.0000	93.8486	93.8486	0.0225	0.0000	94.4107
<b>Total</b>	<b>0.0691</b>	<b>0.6324</b>	<b>0.6627</b>	<b>1.0900e-003</b>		<b>0.0328</b>	<b>0.0328</b>		<b>0.0308</b>	<b>0.0308</b>	<b>0.0000</b>	<b>93.8486</b>	<b>93.8486</b>	<b>0.0225</b>	<b>0.0000</b>	<b>94.4107</b>

Fresno County 18-Unit SFR Project - San Joaquin Valley Unified APCD Air District, Annual

**EMFAC Off-Model Adjustment Factors for Gasoline Light Duty Vehicle to Account for the SAFE Vehicle Rule Not Applied**

**3.5 Building Construction - 2022**

**Mitigated Construction Off-Site**

	ROG	NOx	CO	SO2	Fugitive PM10	Exhaust PM10	PM10 Total	Fugitive PM2.5	Exhaust PM2.5	PM2.5 Total	Bio- CO2	NBio- CO2	Total CO2	CH4	N2O	CO2e
Category	tons/yr										MT/yr					
Hauling	0.0000	0.0000	0.0000	0.0000	0.0000	0.0000	0.0000	0.0000	0.0000	0.0000	0.0000	0.0000	0.0000	0.0000	0.0000	0.0000
Vendor	1.8000e-004	4.4500e-003	1.2800e-003	2.0000e-005	5.4000e-004	5.0000e-005	5.9000e-004	1.6000e-004	5.0000e-005	2.0000e-004	0.0000	1.6265	1.6265	1.0000e-005	2.4000e-004	1.6994
Worker	8.3000e-004	5.9000e-004	6.6200e-003	2.0000e-005	1.9400e-003	1.0000e-005	1.9500e-003	5.2000e-004	1.0000e-005	5.3000e-004	0.0000	1.6052	1.6052	5.0000e-005	5.0000e-005	1.6215
<b>Total</b>	<b>1.0100e-003</b>	<b>5.0400e-003</b>	<b>7.9000e-003</b>	<b>4.0000e-005</b>	<b>2.4800e-003</b>	<b>6.0000e-005</b>	<b>2.5400e-003</b>	<b>6.8000e-004</b>	<b>6.0000e-005</b>	<b>7.3000e-004</b>	<b>0.0000</b>	<b>3.2318</b>	<b>3.2318</b>	<b>6.0000e-005</b>	<b>2.9000e-004</b>	<b>3.3209</b>

**3.5 Building Construction - 2023**

**Unmitigated Construction On-Site**

	ROG	NOx	CO	SO2	Fugitive PM10	Exhaust PM10	PM10 Total	Fugitive PM2.5	Exhaust PM2.5	PM2.5 Total	Bio- CO2	NBio- CO2	Total CO2	CH4	N2O	CO2e
Category	tons/yr										MT/yr					
Off-Road	0.1172	1.0717	1.2102	2.0100e-003		0.0521	0.0521		0.0491	0.0491	0.0000	172.6945	172.6945	0.0411	0.0000	173.7216
<b>Total</b>	<b>0.1172</b>	<b>1.0717</b>	<b>1.2102</b>	<b>2.0100e-003</b>		<b>0.0521</b>	<b>0.0521</b>		<b>0.0491</b>	<b>0.0491</b>	<b>0.0000</b>	<b>172.6945</b>	<b>172.6945</b>	<b>0.0411</b>	<b>0.0000</b>	<b>173.7216</b>



Fresno County 18-Unit SFR Project - San Joaquin Valley Unified APCD Air District, Annual

**EMFAC Off-Model Adjustment Factors for Gasoline Light Duty Vehicle to Account for the SAFE Vehicle Rule Not Applied**

**3.5 Building Construction - 2023**

**Unmitigated Construction Off-Site**

	ROG	NOx	CO	SO2	Fugitive PM10	Exhaust PM10	PM10 Total	Fugitive PM2.5	Exhaust PM2.5	PM2.5 Total	Bio- CO2	NBio- CO2	Total CO2	CH4	N2O	CO2e
Category	tons/yr										MT/yr					
Hauling	0.0000	0.0000	0.0000	0.0000	0.0000	0.0000	0.0000	0.0000	0.0000	0.0000	0.0000	0.0000	0.0000	0.0000	0.0000	0.0000
Vendor	1.6000e-004	6.5900e-003	2.0200e-003	3.0000e-005	9.9000e-004	4.0000e-005	1.0300e-003	2.9000e-004	4.0000e-005	3.3000e-004	0.0000	2.8804	2.8804	1.0000e-005	4.3000e-004	3.0092
Worker	1.4000e-003	9.4000e-004	0.0111	3.0000e-005	3.5700e-003	2.0000e-005	3.5900e-003	9.5000e-004	2.0000e-005	9.7000e-004	0.0000	2.8581	2.8581	9.0000e-005	8.0000e-005	2.8854
<b>Total</b>	<b>1.5600e-003</b>	<b>7.5300e-003</b>	<b>0.0131</b>	<b>6.0000e-005</b>	<b>4.5600e-003</b>	<b>6.0000e-005</b>	<b>4.6200e-003</b>	<b>1.2400e-003</b>	<b>6.0000e-005</b>	<b>1.3000e-003</b>	<b>0.0000</b>	<b>5.7385</b>	<b>5.7385</b>	<b>1.0000e-004</b>	<b>5.1000e-004</b>	<b>5.8946</b>

**Mitigated Construction On-Site**

	ROG	NOx	CO	SO2	Fugitive PM10	Exhaust PM10	PM10 Total	Fugitive PM2.5	Exhaust PM2.5	PM2.5 Total	Bio- CO2	NBio- CO2	Total CO2	CH4	N2O	CO2e
Category	tons/yr										MT/yr					
Off-Road	0.1172	1.0717	1.2102	2.0100e-003		0.0521	0.0521		0.0491	0.0491	0.0000	172.6943	172.6943	0.0411	0.0000	173.7214
<b>Total</b>	<b>0.1172</b>	<b>1.0717</b>	<b>1.2102</b>	<b>2.0100e-003</b>		<b>0.0521</b>	<b>0.0521</b>		<b>0.0491</b>	<b>0.0491</b>	<b>0.0000</b>	<b>172.6943</b>	<b>172.6943</b>	<b>0.0411</b>	<b>0.0000</b>	<b>173.7214</b>

Fresno County 18-Unit SFR Project - San Joaquin Valley Unified APCD Air District, Annual

**EMFAC Off-Model Adjustment Factors for Gasoline Light Duty Vehicle to Account for the SAFE Vehicle Rule Not Applied**

**3.5 Building Construction - 2023**

**Mitigated Construction Off-Site**

	ROG	NOx	CO	SO2	Fugitive PM10	Exhaust PM10	PM10 Total	Fugitive PM2.5	Exhaust PM2.5	PM2.5 Total	Bio- CO2	NBio- CO2	Total CO2	CH4	N2O	CO2e
Category	tons/yr										MT/yr					
Hauling	0.0000	0.0000	0.0000	0.0000	0.0000	0.0000	0.0000	0.0000	0.0000	0.0000	0.0000	0.0000	0.0000	0.0000	0.0000	0.0000
Vendor	1.6000e-004	6.5900e-003	2.0200e-003	3.0000e-005	9.9000e-004	4.0000e-005	1.0300e-003	2.9000e-004	4.0000e-005	3.3000e-004	0.0000	2.8804	2.8804	1.0000e-005	4.3000e-004	3.0092
Worker	1.4000e-003	9.4000e-004	0.0111	3.0000e-005	3.5700e-003	2.0000e-005	3.5900e-003	9.5000e-004	2.0000e-005	9.7000e-004	0.0000	2.8581	2.8581	9.0000e-005	8.0000e-005	2.8854
<b>Total</b>	<b>1.5600e-003</b>	<b>7.5300e-003</b>	<b>0.0131</b>	<b>6.0000e-005</b>	<b>4.5600e-003</b>	<b>6.0000e-005</b>	<b>4.6200e-003</b>	<b>1.2400e-003</b>	<b>6.0000e-005</b>	<b>1.3000e-003</b>	<b>0.0000</b>	<b>5.7385</b>	<b>5.7385</b>	<b>1.0000e-004</b>	<b>5.1000e-004</b>	<b>5.8946</b>

**3.6 Paving - 2023**

**Unmitigated Construction On-Site**

	ROG	NOx	CO	SO2	Fugitive PM10	Exhaust PM10	PM10 Total	Fugitive PM2.5	Exhaust PM2.5	PM2.5 Total	Bio- CO2	NBio- CO2	Total CO2	CH4	N2O	CO2e
Category	tons/yr										MT/yr					
Off-Road	0.0103	0.1019	0.1458	2.3000e-004		5.1000e-003	5.1000e-003		4.6900e-003	4.6900e-003	0.0000	20.0269	20.0269	6.4800e-003	0.0000	20.1888
Paving	0.0000					0.0000	0.0000		0.0000	0.0000	0.0000	0.0000	0.0000	0.0000	0.0000	0.0000
<b>Total</b>	<b>0.0103</b>	<b>0.1019</b>	<b>0.1458</b>	<b>2.3000e-004</b>		<b>5.1000e-003</b>	<b>5.1000e-003</b>		<b>4.6900e-003</b>	<b>4.6900e-003</b>	<b>0.0000</b>	<b>20.0269</b>	<b>20.0269</b>	<b>6.4800e-003</b>	<b>0.0000</b>	<b>20.1888</b>

Fresno County 18-Unit SFR Project - San Joaquin Valley Unified APCD Air District, Annual

**EMFAC Off-Model Adjustment Factors for Gasoline Light Duty Vehicle to Account for the SAFE Vehicle Rule Not Applied**

**3.6 Paving - 2023**

**Unmitigated Construction Off-Site**

	ROG	NOx	CO	SO2	Fugitive PM10	Exhaust PM10	PM10 Total	Fugitive PM2.5	Exhaust PM2.5	PM2.5 Total	Bio- CO2	NBio- CO2	Total CO2	CH4	N2O	CO2e
Category	tons/yr										MT/yr					
Hauling	0.0000	0.0000	0.0000	0.0000	0.0000	0.0000	0.0000	0.0000	0.0000	0.0000	0.0000	0.0000	0.0000	0.0000	0.0000	0.0000
Vendor	0.0000	0.0000	0.0000	0.0000	0.0000	0.0000	0.0000	0.0000	0.0000	0.0000	0.0000	0.0000	0.0000	0.0000	0.0000	0.0000
Worker	4.7000e-004	3.2000e-004	3.7200e-003	1.0000e-005	1.2000e-003	1.0000e-005	1.2100e-003	3.2000e-004	1.0000e-005	3.2000e-004	0.0000	0.9591	0.9591	3.0000e-005	3.0000e-005	0.9683
<b>Total</b>	<b>4.7000e-004</b>	<b>3.2000e-004</b>	<b>3.7200e-003</b>	<b>1.0000e-005</b>	<b>1.2000e-003</b>	<b>1.0000e-005</b>	<b>1.2100e-003</b>	<b>3.2000e-004</b>	<b>1.0000e-005</b>	<b>3.2000e-004</b>	<b>0.0000</b>	<b>0.9591</b>	<b>0.9591</b>	<b>3.0000e-005</b>	<b>3.0000e-005</b>	<b>0.9683</b>

**Mitigated Construction On-Site**

	ROG	NOx	CO	SO2	Fugitive PM10	Exhaust PM10	PM10 Total	Fugitive PM2.5	Exhaust PM2.5	PM2.5 Total	Bio- CO2	NBio- CO2	Total CO2	CH4	N2O	CO2e
Category	tons/yr										MT/yr					
Off-Road	0.0103	0.1019	0.1458	2.3000e-004		5.1000e-003	5.1000e-003		4.6900e-003	4.6900e-003	0.0000	20.0268	20.0268	6.4800e-003	0.0000	20.1888
Paving	0.0000					0.0000	0.0000		0.0000	0.0000	0.0000	0.0000	0.0000	0.0000	0.0000	0.0000
<b>Total</b>	<b>0.0103</b>	<b>0.1019</b>	<b>0.1458</b>	<b>2.3000e-004</b>		<b>5.1000e-003</b>	<b>5.1000e-003</b>		<b>4.6900e-003</b>	<b>4.6900e-003</b>	<b>0.0000</b>	<b>20.0268</b>	<b>20.0268</b>	<b>6.4800e-003</b>	<b>0.0000</b>	<b>20.1888</b>

Fresno County 18-Unit SFR Project - San Joaquin Valley Unified APCD Air District, Annual

**EMFAC Off-Model Adjustment Factors for Gasoline Light Duty Vehicle to Account for the SAFE Vehicle Rule Not Applied**

**3.6 Paving - 2023**

**Mitigated Construction Off-Site**

	ROG	NOx	CO	SO2	Fugitive PM10	Exhaust PM10	PM10 Total	Fugitive PM2.5	Exhaust PM2.5	PM2.5 Total	Bio- CO2	NBio- CO2	Total CO2	CH4	N2O	CO2e
Category	tons/yr										MT/yr					
Hauling	0.0000	0.0000	0.0000	0.0000	0.0000	0.0000	0.0000	0.0000	0.0000	0.0000	0.0000	0.0000	0.0000	0.0000	0.0000	0.0000
Vendor	0.0000	0.0000	0.0000	0.0000	0.0000	0.0000	0.0000	0.0000	0.0000	0.0000	0.0000	0.0000	0.0000	0.0000	0.0000	0.0000
Worker	4.7000e-004	3.2000e-004	3.7200e-003	1.0000e-005	1.2000e-003	1.0000e-005	1.2100e-003	3.2000e-004	1.0000e-005	3.2000e-004	0.0000	0.9591	0.9591	3.0000e-005	3.0000e-005	0.9683
<b>Total</b>	<b>4.7000e-004</b>	<b>3.2000e-004</b>	<b>3.7200e-003</b>	<b>1.0000e-005</b>	<b>1.2000e-003</b>	<b>1.0000e-005</b>	<b>1.2100e-003</b>	<b>3.2000e-004</b>	<b>1.0000e-005</b>	<b>3.2000e-004</b>	<b>0.0000</b>	<b>0.9591</b>	<b>0.9591</b>	<b>3.0000e-005</b>	<b>3.0000e-005</b>	<b>0.9683</b>

**3.7 Architectural Coating - 2023**

**Unmitigated Construction On-Site**

	ROG	NOx	CO	SO2	Fugitive PM10	Exhaust PM10	PM10 Total	Fugitive PM2.5	Exhaust PM2.5	PM2.5 Total	Bio- CO2	NBio- CO2	Total CO2	CH4	N2O	CO2e
Category	tons/yr										MT/yr					
Archit. Coating	0.3041					0.0000	0.0000		0.0000	0.0000	0.0000	0.0000	0.0000	0.0000	0.0000	0.0000
Off-Road	1.9200e-003	0.0130	0.0181	3.0000e-005		7.1000e-004	7.1000e-004		7.1000e-004	7.1000e-004	0.0000	2.5533	2.5533	1.5000e-004	0.0000	2.5571
<b>Total</b>	<b>0.3060</b>	<b>0.0130</b>	<b>0.0181</b>	<b>3.0000e-005</b>		<b>7.1000e-004</b>	<b>7.1000e-004</b>		<b>7.1000e-004</b>	<b>7.1000e-004</b>	<b>0.0000</b>	<b>2.5533</b>	<b>2.5533</b>	<b>1.5000e-004</b>	<b>0.0000</b>	<b>2.5571</b>

Fresno County 18-Unit SFR Project - San Joaquin Valley Unified APCD Air District, Annual

**EMFAC Off-Model Adjustment Factors for Gasoline Light Duty Vehicle to Account for the SAFE Vehicle Rule Not Applied**

**3.7 Architectural Coating - 2023**

**Unmitigated Construction Off-Site**

	ROG	NOx	CO	SO2	Fugitive PM10	Exhaust PM10	PM10 Total	Fugitive PM2.5	Exhaust PM2.5	PM2.5 Total	Bio- CO2	NBio- CO2	Total CO2	CH4	N2O	CO2e
Category	tons/yr										MT/yr					
Hauling	0.0000	0.0000	0.0000	0.0000	0.0000	0.0000	0.0000	0.0000	0.0000	0.0000	0.0000	0.0000	0.0000	0.0000	0.0000	0.0000
Vendor	0.0000	0.0000	0.0000	0.0000	0.0000	0.0000	0.0000	0.0000	0.0000	0.0000	0.0000	0.0000	0.0000	0.0000	0.0000	0.0000
Worker	3.0000e-005	2.0000e-005	2.5000e-004	0.0000	8.0000e-005	0.0000	8.0000e-005	2.0000e-005	0.0000	2.0000e-005	0.0000	0.0639	0.0639	0.0000	0.0000	0.0646
<b>Total</b>	<b>3.0000e-005</b>	<b>2.0000e-005</b>	<b>2.5000e-004</b>	<b>0.0000</b>	<b>8.0000e-005</b>	<b>0.0000</b>	<b>8.0000e-005</b>	<b>2.0000e-005</b>	<b>0.0000</b>	<b>2.0000e-005</b>	<b>0.0000</b>	<b>0.0639</b>	<b>0.0639</b>	<b>0.0000</b>	<b>0.0000</b>	<b>0.0646</b>

**Mitigated Construction On-Site**

	ROG	NOx	CO	SO2	Fugitive PM10	Exhaust PM10	PM10 Total	Fugitive PM2.5	Exhaust PM2.5	PM2.5 Total	Bio- CO2	NBio- CO2	Total CO2	CH4	N2O	CO2e
Category	tons/yr										MT/yr					
Archit. Coating	0.3041					0.0000	0.0000		0.0000	0.0000	0.0000	0.0000	0.0000	0.0000	0.0000	0.0000
Off-Road	1.9200e-003	0.0130	0.0181	3.0000e-005		7.1000e-004	7.1000e-004		7.1000e-004	7.1000e-004	0.0000	2.5533	2.5533	1.5000e-004	0.0000	2.5571
<b>Total</b>	<b>0.3060</b>	<b>0.0130</b>	<b>0.0181</b>	<b>3.0000e-005</b>		<b>7.1000e-004</b>	<b>7.1000e-004</b>		<b>7.1000e-004</b>	<b>7.1000e-004</b>	<b>0.0000</b>	<b>2.5533</b>	<b>2.5533</b>	<b>1.5000e-004</b>	<b>0.0000</b>	<b>2.5571</b>



Fresno County 18-Unit SFR Project - San Joaquin Valley Unified APCD Air District, Annual

**EMFAC Off-Model Adjustment Factors for Gasoline Light Duty Vehicle to Account for the SAFE Vehicle Rule Not Applied**

**3.7 Architectural Coating - 2023**

**Mitigated Construction Off-Site**

	ROG	NOx	CO	SO2	Fugitive PM10	Exhaust PM10	PM10 Total	Fugitive PM2.5	Exhaust PM2.5	PM2.5 Total	Bio- CO2	NBio- CO2	Total CO2	CH4	N2O	CO2e
Category	tons/yr										MT/yr					
Hauling	0.0000	0.0000	0.0000	0.0000	0.0000	0.0000	0.0000	0.0000	0.0000	0.0000	0.0000	0.0000	0.0000	0.0000	0.0000	0.0000
Vendor	0.0000	0.0000	0.0000	0.0000	0.0000	0.0000	0.0000	0.0000	0.0000	0.0000	0.0000	0.0000	0.0000	0.0000	0.0000	0.0000
Worker	3.0000e-005	2.0000e-005	2.5000e-004	0.0000	8.0000e-005	0.0000	8.0000e-005	2.0000e-005	0.0000	2.0000e-005	0.0000	0.0639	0.0639	0.0000	0.0000	0.0646
<b>Total</b>	<b>3.0000e-005</b>	<b>2.0000e-005</b>	<b>2.5000e-004</b>	<b>0.0000</b>	<b>8.0000e-005</b>	<b>0.0000</b>	<b>8.0000e-005</b>	<b>2.0000e-005</b>	<b>0.0000</b>	<b>2.0000e-005</b>	<b>0.0000</b>	<b>0.0639</b>	<b>0.0639</b>	<b>0.0000</b>	<b>0.0000</b>	<b>0.0646</b>

Fresno County 18-Unit SFR Project - San Joaquin Valley Unified APCD Air District, Annual

**EMFAC Off-Model Adjustment Factors for Gasoline Light Duty Vehicle to Account for the SAFE Vehicle Rule Not Applied**

**4.0 Operational Detail - Mobile**

**4.1 Mitigation Measures Mobile**

	ROG	NOx	CO	SO2	Fugitive PM10	Exhaust PM10	PM10 Total	Fugitive PM2.5	Exhaust PM2.5	PM2.5 Total	Bio- CO2	NBio- CO2	Total CO2	CH4	N2O	CO2e
Category	tons/yr										MT/yr					
Mitigated	0.0849	0.1517	0.7980	1.9100e-003	0.1826	1.7100e-003	0.1843	0.0489	1.6000e-003	0.0505	0.0000	176.3750	176.3750	9.3800e-003	9.9900e-003	179.5870
Unmitigated	0.0849	0.1517	0.7980	1.9100e-003	0.1826	1.7100e-003	0.1843	0.0489	1.6000e-003	0.0505	0.0000	176.3750	176.3750	9.3800e-003	9.9900e-003	179.5870

**4.2 Trip Summary Information**

Land Use	Average Daily Trip Rate			Unmitigated	Mitigated
	Weekday	Saturday	Sunday	Annual VMT	Annual VMT
Single Family Housing	169.92	171.72	153.90	486,510	486,510
Total	169.92	171.72	153.90	486,510	486,510

**4.3 Trip Type Information**

Land Use	Miles			Trip %			Trip Purpose %		
	H-W or C-W	H-S or C-C	H-O or C-NW	H-W or C-W	H-S or C-C	H-O or C-NW	Primary	Diverted	Pass-by
Single Family Housing	10.80	7.30	7.50	45.60	19.00	35.40	86	11	3

**4.4 Fleet Mix**

Land Use	LDA	LDT1	LDT2	MDV	LHD1	LHD2	MHD	HHD	OBUS	UBUS	MCY	SBUS	MH
Single Family Housing	0.511221	0.052103	0.170611	0.160645	0.028932	0.007649	0.013284	0.025916	0.000654	0.000315	0.023645	0.001472	0.003552

Fresno County 18-Unit SFR Project - San Joaquin Valley Unified APCD Air District, Annual

**EMFAC Off-Model Adjustment Factors for Gasoline Light Duty Vehicle to Account for the SAFE Vehicle Rule Not Applied**

**5.0 Energy Detail**

Historical Energy Use: N

**5.1 Mitigation Measures Energy**

	ROG	NOx	CO	SO2	Fugitive PM10	Exhaust PM10	PM10 Total	Fugitive PM2.5	Exhaust PM2.5	PM2.5 Total	Bio- CO2	NBio- CO2	Total CO2	CH4	N2O	CO2e
Category	tons/yr										MT/yr					
Electricity Mitigated						0.0000	0.0000		0.0000	0.0000	0.0000	13.2218	13.2218	2.1400e-003	2.6000e-004	13.3525
Electricity Unmitigated						0.0000	0.0000		0.0000	0.0000	0.0000	13.2218	13.2218	2.1400e-003	2.6000e-004	13.3525
NaturalGas Mitigated	2.3100e-003	0.0197	8.3900e-003	1.3000e-004		1.5900e-003	1.5900e-003		1.5900e-003	1.5900e-003	0.0000	22.8255	22.8255	4.4000e-004	4.2000e-004	22.9612
NaturalGas Unmitigated	2.3100e-003	0.0197	8.3900e-003	1.3000e-004		1.5900e-003	1.5900e-003		1.5900e-003	1.5900e-003	0.0000	22.8255	22.8255	4.4000e-004	4.2000e-004	22.9612

Fresno County 18-Unit SFR Project - San Joaquin Valley Unified APCD Air District, Annual

**EMFAC Off-Model Adjustment Factors for Gasoline Light Duty Vehicle to Account for the SAFE Vehicle Rule Not Applied**

**5.2 Energy by Land Use - Natural Gas**

**Unmitigated**

	Natural Gas Use	ROG	NOx	CO	SO2	Fugitive PM10	Exhaust PM10	PM10 Total	Fugitive PM2.5	Exhaust PM2.5	PM2.5 Total	Bio- CO2	NBio- CO2	Total CO2	CH4	N2O	CO2e
Land Use	kBTU/yr	tons/yr										MT/yr					
Single Family Housing	427734	2.3100e-003	0.0197	8.3900e-003	1.3000e-004		1.5900e-003	1.5900e-003		1.5900e-003	1.5900e-003	0.0000	22.8255	22.8255	4.4000e-004	4.2000e-004	22.9612
<b>Total</b>		<b>2.3100e-003</b>	<b>0.0197</b>	<b>8.3900e-003</b>	<b>1.3000e-004</b>		<b>1.5900e-003</b>	<b>1.5900e-003</b>		<b>1.5900e-003</b>	<b>1.5900e-003</b>	<b>0.0000</b>	<b>22.8255</b>	<b>22.8255</b>	<b>4.4000e-004</b>	<b>4.2000e-004</b>	<b>22.9612</b>

**Mitigated**

	Natural Gas Use	ROG	NOx	CO	SO2	Fugitive PM10	Exhaust PM10	PM10 Total	Fugitive PM2.5	Exhaust PM2.5	PM2.5 Total	Bio- CO2	NBio- CO2	Total CO2	CH4	N2O	CO2e
Land Use	kBTU/yr	tons/yr										MT/yr					
Single Family Housing	427734	2.3100e-003	0.0197	8.3900e-003	1.3000e-004		1.5900e-003	1.5900e-003		1.5900e-003	1.5900e-003	0.0000	22.8255	22.8255	4.4000e-004	4.2000e-004	22.9612
<b>Total</b>		<b>2.3100e-003</b>	<b>0.0197</b>	<b>8.3900e-003</b>	<b>1.3000e-004</b>		<b>1.5900e-003</b>	<b>1.5900e-003</b>		<b>1.5900e-003</b>	<b>1.5900e-003</b>	<b>0.0000</b>	<b>22.8255</b>	<b>22.8255</b>	<b>4.4000e-004</b>	<b>4.2000e-004</b>	<b>22.9612</b>

Fresno County 18-Unit SFR Project - San Joaquin Valley Unified APCD Air District, Annual

**EMFAC Off-Model Adjustment Factors for Gasoline Light Duty Vehicle to Account for the SAFE Vehicle Rule Not Applied**

**5.3 Energy by Land Use - Electricity**

Unmitigated

	Electricity Use	Total CO2	CH4	N2O	CO2e
Land Use	kWh/yr	MT/yr			
Single Family Housing	142901	13.2218	2.1400e-003	2.6000e-004	13.3525
<b>Total</b>		<b>13.2218</b>	<b>2.1400e-003</b>	<b>2.6000e-004</b>	<b>13.3525</b>

Mitigated

	Electricity Use	Total CO2	CH4	N2O	CO2e
Land Use	kWh/yr	MT/yr			
Single Family Housing	142901	13.2218	2.1400e-003	2.6000e-004	13.3525
<b>Total</b>		<b>13.2218</b>	<b>2.1400e-003</b>	<b>2.6000e-004</b>	<b>13.3525</b>

**6.0 Area Detail**

**6.1 Mitigation Measures Area**

Fresno County 18-Unit SFR Project - San Joaquin Valley Unified APCD Air District, Annual

**EMFAC Off-Model Adjustment Factors for Gasoline Light Duty Vehicle to Account for the SAFE Vehicle Rule Not Applied**

	ROG	NOx	CO	SO2	Fugitive PM10	Exhaust PM10	PM10 Total	Fugitive PM2.5	Exhaust PM2.5	PM2.5 Total	Bio- CO2	NBio- CO2	Total CO2	CH4	N2O	CO2e
Category	tons/yr										MT/yr					
Mitigated	0.1618	8.2700e-003	0.1365	5.0000e-005		1.2800e-003	1.2800e-003		1.2800e-003	1.2800e-003	0.0000	8.0161	8.0161	3.6000e-004	1.4000e-004	8.0676
Unmitigated	0.1618	8.2700e-003	0.1365	5.0000e-005		1.2800e-003	1.2800e-003		1.2800e-003	1.2800e-003	0.0000	8.0161	8.0161	3.6000e-004	1.4000e-004	8.0676

**6.2 Area by SubCategory**

**Unmitigated**

	ROG	NOx	CO	SO2	Fugitive PM10	Exhaust PM10	PM10 Total	Fugitive PM2.5	Exhaust PM2.5	PM2.5 Total	Bio- CO2	NBio- CO2	Total CO2	CH4	N2O	CO2e
SubCategory	tons/yr										MT/yr					
Architectural Coating	0.0304					0.0000	0.0000		0.0000	0.0000	0.0000	0.0000	0.0000	0.0000	0.0000	0.0000
Consumer Products	0.1265					0.0000	0.0000		0.0000	0.0000	0.0000	0.0000	0.0000	0.0000	0.0000	0.0000
Hearth	7.9000e-004	6.7300e-003	2.8700e-003	4.0000e-005		5.4000e-004	5.4000e-004		5.4000e-004	5.4000e-004	0.0000	7.7977	7.7977	1.5000e-004	1.4000e-004	7.8441
Landscaping	4.0200e-003	1.5400e-003	0.1336	1.0000e-005		7.4000e-004	7.4000e-004		7.4000e-004	7.4000e-004	0.0000	0.2183	0.2183	2.1000e-004	0.0000	0.2236
<b>Total</b>	<b>0.1618</b>	<b>8.2700e-003</b>	<b>0.1365</b>	<b>5.0000e-005</b>		<b>1.2800e-003</b>	<b>1.2800e-003</b>		<b>1.2800e-003</b>	<b>1.2800e-003</b>	<b>0.0000</b>	<b>8.0161</b>	<b>8.0161</b>	<b>3.6000e-004</b>	<b>1.4000e-004</b>	<b>8.0676</b>



Fresno County 18-Unit SFR Project - San Joaquin Valley Unified APCD Air District, Annual

**EMFAC Off-Model Adjustment Factors for Gasoline Light Duty Vehicle to Account for the SAFE Vehicle Rule Not Applied**

**6.2 Area by SubCategory**

Mitigated

	ROG	NOx	CO	SO2	Fugitive PM10	Exhaust PM10	PM10 Total	Fugitive PM2.5	Exhaust PM2.5	PM2.5 Total	Bio- CO2	NBio- CO2	Total CO2	CH4	N2O	CO2e
SubCategory	tons/yr										MT/yr					
Architectural Coating	0.0304					0.0000	0.0000		0.0000	0.0000	0.0000	0.0000	0.0000	0.0000	0.0000	0.0000
Consumer Products	0.1265					0.0000	0.0000		0.0000	0.0000	0.0000	0.0000	0.0000	0.0000	0.0000	0.0000
Hearth	7.9000e-004	6.7300e-003	2.8700e-003	4.0000e-005		5.4000e-004	5.4000e-004		5.4000e-004	5.4000e-004	0.0000	7.7977	7.7977	1.5000e-004	1.4000e-004	7.8441
Landscaping	4.0200e-003	1.5400e-003	0.1336	1.0000e-005		7.4000e-004	7.4000e-004		7.4000e-004	7.4000e-004	0.0000	0.2183	0.2183	2.1000e-004	0.0000	0.2236
<b>Total</b>	<b>0.1618</b>	<b>8.2700e-003</b>	<b>0.1365</b>	<b>5.0000e-005</b>		<b>1.2800e-003</b>	<b>1.2800e-003</b>		<b>1.2800e-003</b>	<b>1.2800e-003</b>	<b>0.0000</b>	<b>8.0161</b>	<b>8.0161</b>	<b>3.6000e-004</b>	<b>1.4000e-004</b>	<b>8.0676</b>

**7.0 Water Detail**

**7.1 Mitigation Measures Water**

Fresno County 18-Unit SFR Project - San Joaquin Valley Unified APCD Air District, Annual

**EMFAC Off-Model Adjustment Factors for Gasoline Light Duty Vehicle to Account for the SAFE Vehicle Rule Not Applied**

	Total CO2	CH4	N2O	CO2e
Category	MT/yr			
Mitigated	1.1986	0.0384	9.2000e-004	2.4311
Unmitigated	1.1986	0.0384	9.2000e-004	2.4311

**7.2 Water by Land Use**

**Unmitigated**

	Indoor/Outdoor Use	Total CO2	CH4	N2O	CO2e
Land Use	Mgal	MT/yr			
Single Family Housing	1.17277 / 0.739357	1.1986	0.0384	9.2000e-004	2.4311
<b>Total</b>		<b>1.1986</b>	<b>0.0384</b>	<b>9.2000e-004</b>	<b>2.4311</b>

Fresno County 18-Unit SFR Project - San Joaquin Valley Unified APCD Air District, Annual

**EMFAC Off-Model Adjustment Factors for Gasoline Light Duty Vehicle to Account for the SAFE Vehicle Rule Not Applied**

**7.2 Water by Land Use**

Mitigated

	Indoor/Outdoor Use	Total CO2	CH4	N2O	CO2e
Land Use	Mgal	MT/yr			
Single Family Housing	1.17277 / 0.739357	1.1986	0.0384	9.2000e-004	2.4311
<b>Total</b>		<b>1.1986</b>	<b>0.0384</b>	<b>9.2000e-004</b>	<b>2.4311</b>

**8.0 Waste Detail**

---

**8.1 Mitigation Measures Waste**

Category/Year

	Total CO2	CH4	N2O	CO2e
	MT/yr			
Mitigated	4.3542	0.2573	0.0000	10.7872
Unmitigated	4.3542	0.2573	0.0000	10.7872

Fresno County 18-Unit SFR Project - San Joaquin Valley Unified APCD Air District, Annual

**EMFAC Off-Model Adjustment Factors for Gasoline Light Duty Vehicle to Account for the SAFE Vehicle Rule Not Applied**

**8.2 Waste by Land Use**

Unmitigated

	Waste Disposed	Total CO2	CH4	N2O	CO2e
Land Use	tons	MT/yr			
Single Family Housing	21.45	4.3542	0.2573	0.0000	10.7872
<b>Total</b>		<b>4.3542</b>	<b>0.2573</b>	<b>0.0000</b>	<b>10.7872</b>

Mitigated

	Waste Disposed	Total CO2	CH4	N2O	CO2e
Land Use	tons	MT/yr			
Single Family Housing	21.45	4.3542	0.2573	0.0000	10.7872
<b>Total</b>		<b>4.3542</b>	<b>0.2573</b>	<b>0.0000</b>	<b>10.7872</b>

**9.0 Operational Offroad**

---

Equipment Type	Number	Hours/Day	Days/Year	Horse Power	Load Factor	Fuel Type
----------------	--------	-----------	-----------	-------------	-------------	-----------

Fresno County 18-Unit SFR Project - San Joaquin Valley Unified APCD Air District, Annual

**EMFAC Off-Model Adjustment Factors for Gasoline Light Duty Vehicle to Account for the SAFE Vehicle Rule Not Applied**

**10.0 Stationary Equipment**

---

**Fire Pumps and Emergency Generators**

Equipment Type	Number	Hours/Day	Hours/Year	Horse Power	Load Factor	Fuel Type
----------------	--------	-----------	------------	-------------	-------------	-----------

**Boilers**

Equipment Type	Number	Heat Input/Day	Heat Input/Year	Boiler Rating	Fuel Type
----------------	--------	----------------	-----------------	---------------	-----------

**User Defined Equipment**

Equipment Type	Number
----------------	--------

**11.0 Vegetation**

---

Fresno County 18-Unit SFR Project - San Joaquin Valley Unified APCD Air District, Summer

**EMFAC Off-Model Adjustment Factors for Gasoline Light Duty Vehicle to Account for the SAFE Vehicle Rule Not Applied**

**Fresno County 18-Unit SFR Project**  
**San Joaquin Valley Unified APCD Air District, Summer**

**1.0 Project Characteristics**

---

**1.1 Land Usage**

Land Uses	Size	Metric	Lot Acreage	Floor Surface Area	Population
Single Family Housing	18.00	Dwelling Unit	5.84	32,400.00	57

**1.2 Other Project Characteristics**

<b>Urbanization</b>	Urban	<b>Wind Speed (m/s)</b>	2.7	<b>Precipitation Freq (Days)</b>	45
<b>Climate Zone</b>	7			<b>Operational Year</b>	2024
<b>Utility Company</b>	Pacific Gas and Electric Company				
<b>CO2 Intensity (lb/MWhr)</b>	203.98	<b>CH4 Intensity (lb/MWhr)</b>	0.033	<b>N2O Intensity (lb/MWhr)</b>	0.004

**1.3 User Entered Comments & Non-Default Data**

Project Characteristics -

Land Use -

Construction Off-road Equipment Mitigation -

Table Name	Column Name	Default Value	New Value
tblWoodstoves	NumberCatalytic	5.84	0.00
tblWoodstoves	NumberNoncatalytic	5.84	0.00

**2.0 Emissions Summary**

---

Fresno County 18-Unit SFR Project - San Joaquin Valley Unified APCD Air District, Summer

**EMFAC Off-Model Adjustment Factors for Gasoline Light Duty Vehicle to Account for the SAFE Vehicle Rule Not Applied**

**2.1 Overall Construction (Maximum Daily Emission)**

**Unmitigated Construction**

	ROG	NOx	CO	SO2	Fugitive PM10	Exhaust PM10	PM10 Total	Fugitive PM2.5	Exhaust PM2.5	PM2.5 Total	Bio- CO2	NBio- CO2	Total CO2	CH4	N2O	CO2e
Year	lb/day										lb/day					
2022	3.2415	33.1238	21.0673	0.0400	19.8049	1.6134	21.4183	10.1417	1.4843	11.6260	0.0000	3,865.5788	3,865.5788	1.1965	7.9200e-003	3,892.9439
2023	30.6055	14.4812	16.4427	0.0278	0.1232	0.7006	0.7634	0.0327	0.6592	0.6762	0.0000	2,643.7748	2,643.7748	0.7172	7.5600e-003	2,661.2592
<b>Maximum</b>	<b>30.6055</b>	<b>33.1238</b>	<b>21.0673</b>	<b>0.0400</b>	<b>19.8049</b>	<b>1.6134</b>	<b>21.4183</b>	<b>10.1417</b>	<b>1.4843</b>	<b>11.6260</b>	<b>0.0000</b>	<b>3,865.5788</b>	<b>3,865.5788</b>	<b>1.1965</b>	<b>7.9200e-003</b>	<b>3,892.9439</b>

**Mitigated Construction**

	ROG	NOx	CO	SO2	Fugitive PM10	Exhaust PM10	PM10 Total	Fugitive PM2.5	Exhaust PM2.5	PM2.5 Total	Bio- CO2	NBio- CO2	Total CO2	CH4	N2O	CO2e
Year	lb/day										lb/day					
2022	3.2415	33.1238	21.0673	0.0400	8.5512	1.6134	10.1646	4.3580	1.4843	5.8423	0.0000	3,865.5788	3,865.5788	1.1965	7.9200e-003	3,892.9439
2023	30.6055	14.4812	16.4427	0.0278	0.1232	0.7006	0.7634	0.0327	0.6592	0.6762	0.0000	2,643.7748	2,643.7748	0.7172	7.5600e-003	2,661.2592
<b>Maximum</b>	<b>30.6055</b>	<b>33.1238</b>	<b>21.0673</b>	<b>0.0400</b>	<b>8.5512</b>	<b>1.6134</b>	<b>10.1646</b>	<b>4.3580</b>	<b>1.4843</b>	<b>5.8423</b>	<b>0.0000</b>	<b>3,865.5788</b>	<b>3,865.5788</b>	<b>1.1965</b>	<b>7.9200e-003</b>	<b>3,892.9439</b>





Fresno County 18-Unit SFR Project - San Joaquin Valley Unified APCD Air District, Summer

**EMFAC Off-Model Adjustment Factors for Gasoline Light Duty Vehicle to Account for the SAFE Vehicle Rule Not Applied**

**2.2 Overall Operational**

**Unmitigated Operational**

	ROG	NOx	CO	SO2	Fugitive PM10	Exhaust PM10	PM10 Total	Fugitive PM2.5	Exhaust PM2.5	PM2.5 Total	Bio- CO2	NBio- CO2	Total CO2	CH4	N2O	CO2e
Category	lb/day										lb/day					
Area	0.9238	0.1813	1.5543	1.1300e-003		0.0215	0.0215		0.0215	0.0215	0.0000	212.3210	212.3210	6.5800e-003	3.8400e-003	213.6310
Energy	0.0126	0.1080	0.0460	6.9000e-004		8.7300e-003	8.7300e-003		8.7300e-003	8.7300e-003		137.8676	137.8676	2.6400e-003	2.5300e-003	138.6869
Mobile	0.5712	0.8017	4.8232	0.0114	1.0539	9.6000e-003	1.0635	0.2815	9.0100e-003	0.2905		1,160.6481	1,160.6481	0.0557	0.0603	1,180.0093
<b>Total</b>	<b>1.5076</b>	<b>1.0910</b>	<b>6.4234</b>	<b>0.0132</b>	<b>1.0539</b>	<b>0.0398</b>	<b>1.0938</b>	<b>0.2815</b>	<b>0.0392</b>	<b>0.3207</b>	<b>0.0000</b>	<b>1,510.8368</b>	<b>1,510.8368</b>	<b>0.0649</b>	<b>0.0667</b>	<b>1,532.3271</b>

**Mitigated Operational**

	ROG	NOx	CO	SO2	Fugitive PM10	Exhaust PM10	PM10 Total	Fugitive PM2.5	Exhaust PM2.5	PM2.5 Total	Bio- CO2	NBio- CO2	Total CO2	CH4	N2O	CO2e
Category	lb/day										lb/day					
Area	0.9238	0.1813	1.5543	1.1300e-003		0.0215	0.0215		0.0215	0.0215	0.0000	212.3210	212.3210	6.5800e-003	3.8400e-003	213.6310
Energy	0.0126	0.1080	0.0460	6.9000e-004		8.7300e-003	8.7300e-003		8.7300e-003	8.7300e-003		137.8676	137.8676	2.6400e-003	2.5300e-003	138.6869
Mobile	0.5712	0.8017	4.8232	0.0114	1.0539	9.6000e-003	1.0635	0.2815	9.0100e-003	0.2905		1,160.6481	1,160.6481	0.0557	0.0603	1,180.0093
<b>Total</b>	<b>1.5076</b>	<b>1.0910</b>	<b>6.4234</b>	<b>0.0132</b>	<b>1.0539</b>	<b>0.0398</b>	<b>1.0938</b>	<b>0.2815</b>	<b>0.0392</b>	<b>0.3207</b>	<b>0.0000</b>	<b>1,510.8368</b>	<b>1,510.8368</b>	<b>0.0649</b>	<b>0.0667</b>	<b>1,532.3271</b>

Fresno County 18-Unit SFR Project - San Joaquin Valley Unified APCD Air District, Summer

**EMFAC Off-Model Adjustment Factors for Gasoline Light Duty Vehicle to Account for the SAFE Vehicle Rule Not Applied**

	ROG	NOx	CO	SO2	Fugitive PM10	Exhaust PM10	PM10 Total	Fugitive PM2.5	Exhaust PM2.5	PM2.5 Total	Bio- CO2	NBio-CO2	Total CO2	CH4	N2O	CO2e
Percent Reduction	0.00	0.00	0.00	0.00	0.00	0.00	0.00	0.00	0.00	0.00	0.00	0.00	0.00	0.00	0.00	0.00

**3.0 Construction Detail**

**Construction Phase**

Phase Number	Phase Name	Phase Type	Start Date	End Date	Num Days Week	Num Days	Phase Description
1	Demolition	Demolition	7/1/2022	7/28/2022	5	20	
2	Site Preparation	Site Preparation	7/29/2022	8/11/2022	5	10	
3	Grading	Grading	8/12/2022	9/8/2022	5	20	
4	Building Construction	Building Construction	9/9/2022	7/27/2023	5	230	
5	Paving	Paving	7/28/2023	8/24/2023	5	20	
6	Architectural Coating	Architectural Coating	8/25/2023	9/21/2023	5	20	

**Acres of Grading (Site Preparation Phase): 15**

**Acres of Grading (Grading Phase): 20**

**Acres of Paving: 0**

**Residential Indoor: 65,610; Residential Outdoor: 21,870; Non-Residential Indoor: 0; Non-Residential Outdoor: 0; Striped Parking Area: 0 (Architectural Coating – sqft)**

**OffRoad Equipment**

Phase Name	Offroad Equipment Type	Amount	Usage Hours	Horse Power	Load Factor
Architectural Coating	Air Compressors	1	6.00	78	0.48
Demolition	Concrete/Industrial Saws	1	8.00	81	0.73
Building Construction	Cranes	1	7.00	231	0.29
Demolition	Excavators	3	8.00	158	0.38
Grading	Excavators	1	8.00	158	0.38

Fresno County 18-Unit SFR Project - San Joaquin Valley Unified APCD Air District, Summer

**EMFAC Off-Model Adjustment Factors for Gasoline Light Duty Vehicle to Account for the SAFE Vehicle Rule Not Applied**

Building Construction	Forklifts	3	8.00	89	0.20
Building Construction	Generator Sets	1	8.00	84	0.74
Grading	Graders	1	8.00	187	0.41
Paving	Pavers	2	8.00	130	0.42
Paving	Paving Equipment	2	8.00	132	0.36
Paving	Rollers	2	8.00	80	0.38
Demolition	Rubber Tired Dozers	2	8.00	247	0.40
Grading	Rubber Tired Dozers	1	8.00	247	0.40
Site Preparation	Rubber Tired Dozers	3	8.00	247	0.40
Building Construction	Tractors/Loaders/Backhoes	3	7.00	97	0.37
Grading	Tractors/Loaders/Backhoes	3	8.00	97	0.37
Site Preparation	Tractors/Loaders/Backhoes	4	8.00	97	0.37
Building Construction	Welders	1	8.00	46	0.45

**Trips and VMT**

Phase Name	Offroad Equipment Count	Worker Trip Number	Vendor Trip Number	Hauling Trip Number	Worker Trip Length	Vendor Trip Length	Hauling Trip Length	Worker Vehicle Class	Vendor Vehicle Class	Hauling Vehicle Class
Demolition	6	15.00	0.00	0.00	10.80	7.30	20.00	LD_Mix	HDT_Mix	HHDT
Site Preparation	7	18.00	0.00	0.00	10.80	7.30	20.00	LD_Mix	HDT_Mix	HHDT
Grading	6	15.00	0.00	0.00	10.80	7.30	20.00	LD_Mix	HDT_Mix	HHDT
Building Construction	9	6.00	2.00	0.00	10.80	7.30	20.00	LD_Mix	HDT_Mix	HHDT
Paving	6	15.00	0.00	0.00	10.80	7.30	20.00	LD_Mix	HDT_Mix	HHDT
Architectural Coating	1	1.00	0.00	0.00	10.80	7.30	20.00	LD_Mix	HDT_Mix	HHDT

**3.1 Mitigation Measures Construction**

Use Soil Stabilizer

Replace Ground Cover

Water Exposed Area

Fresno County 18-Unit SFR Project - San Joaquin Valley Unified APCD Air District, Summer

**EMFAC Off-Model Adjustment Factors for Gasoline Light Duty Vehicle to Account for the SAFE Vehicle Rule Not Applied**

**3.2 Demolition - 2022**

**Unmitigated Construction On-Site**

	ROG	NOx	CO	SO2	Fugitive PM10	Exhaust PM10	PM10 Total	Fugitive PM2.5	Exhaust PM2.5	PM2.5 Total	Bio- CO2	NBio- CO2	Total CO2	CH4	N2O	CO2e
Category	lb/day										lb/day					
Off-Road	2.6392	25.7194	20.5941	0.0388		1.2427	1.2427		1.1553	1.1553		3,746.7812	3,746.7812	1.0524		3,773.0920
<b>Total</b>	<b>2.6392</b>	<b>25.7194</b>	<b>20.5941</b>	<b>0.0388</b>		<b>1.2427</b>	<b>1.2427</b>		<b>1.1553</b>	<b>1.1553</b>		<b>3,746.7812</b>	<b>3,746.7812</b>	<b>1.0524</b>		<b>3,773.0920</b>

**Unmitigated Construction Off-Site**

	ROG	NOx	CO	SO2	Fugitive PM10	Exhaust PM10	PM10 Total	Fugitive PM2.5	Exhaust PM2.5	PM2.5 Total	Bio- CO2	NBio- CO2	Total CO2	CH4	N2O	CO2e
Category	lb/day										lb/day					
Hauling	0.0000	0.0000	0.0000	0.0000	0.0000	0.0000	0.0000	0.0000	0.0000	0.0000		0.0000	0.0000	0.0000	0.0000	0.0000
Vendor	0.0000	0.0000	0.0000	0.0000	0.0000	0.0000	0.0000	0.0000	0.0000	0.0000		0.0000	0.0000	0.0000	0.0000	0.0000
Worker	0.0594	0.0336	0.4732	1.1800e-003	0.1232	6.7000e-004	0.1239	0.0327	6.2000e-004	0.0333		118.7976	118.7976	3.6000e-003	3.2400e-003	119.8518
<b>Total</b>	<b>0.0594</b>	<b>0.0336</b>	<b>0.4732</b>	<b>1.1800e-003</b>	<b>0.1232</b>	<b>6.7000e-004</b>	<b>0.1239</b>	<b>0.0327</b>	<b>6.2000e-004</b>	<b>0.0333</b>		<b>118.7976</b>	<b>118.7976</b>	<b>3.6000e-003</b>	<b>3.2400e-003</b>	<b>119.8518</b>

Fresno County 18-Unit SFR Project - San Joaquin Valley Unified APCD Air District, Summer

**EMFAC Off-Model Adjustment Factors for Gasoline Light Duty Vehicle to Account for the SAFE Vehicle Rule Not Applied**

**3.2 Demolition - 2022**

**Mitigated Construction On-Site**

	ROG	NOx	CO	SO2	Fugitive PM10	Exhaust PM10	PM10 Total	Fugitive PM2.5	Exhaust PM2.5	PM2.5 Total	Bio- CO2	NBio- CO2	Total CO2	CH4	N2O	CO2e
Category	lb/day										lb/day					
Off-Road	2.6392	25.7194	20.5941	0.0388		1.2427	1.2427		1.1553	1.1553	0.0000	3,746.7812	3,746.7812	1.0524		3,773.0920
<b>Total</b>	<b>2.6392</b>	<b>25.7194</b>	<b>20.5941</b>	<b>0.0388</b>		<b>1.2427</b>	<b>1.2427</b>		<b>1.1553</b>	<b>1.1553</b>	<b>0.0000</b>	<b>3,746.7812</b>	<b>3,746.7812</b>	<b>1.0524</b>		<b>3,773.0920</b>

**Mitigated Construction Off-Site**

	ROG	NOx	CO	SO2	Fugitive PM10	Exhaust PM10	PM10 Total	Fugitive PM2.5	Exhaust PM2.5	PM2.5 Total	Bio- CO2	NBio- CO2	Total CO2	CH4	N2O	CO2e
Category	lb/day										lb/day					
Hauling	0.0000	0.0000	0.0000	0.0000	0.0000	0.0000	0.0000	0.0000	0.0000	0.0000		0.0000	0.0000	0.0000	0.0000	0.0000
Vendor	0.0000	0.0000	0.0000	0.0000	0.0000	0.0000	0.0000	0.0000	0.0000	0.0000		0.0000	0.0000	0.0000	0.0000	0.0000
Worker	0.0594	0.0336	0.4732	1.1800e-003	0.1232	6.7000e-004	0.1239	0.0327	6.2000e-004	0.0333		118.7976	118.7976	3.6000e-003	3.2400e-003	119.8518
<b>Total</b>	<b>0.0594</b>	<b>0.0336</b>	<b>0.4732</b>	<b>1.1800e-003</b>	<b>0.1232</b>	<b>6.7000e-004</b>	<b>0.1239</b>	<b>0.0327</b>	<b>6.2000e-004</b>	<b>0.0333</b>		<b>118.7976</b>	<b>118.7976</b>	<b>3.6000e-003</b>	<b>3.2400e-003</b>	<b>119.8518</b>

Fresno County 18-Unit SFR Project - San Joaquin Valley Unified APCD Air District, Summer

**EMFAC Off-Model Adjustment Factors for Gasoline Light Duty Vehicle to Account for the SAFE Vehicle Rule Not Applied**

**3.3 Site Preparation - 2022**

**Unmitigated Construction On-Site**

	ROG	NOx	CO	SO2	Fugitive PM10	Exhaust PM10	PM10 Total	Fugitive PM2.5	Exhaust PM2.5	PM2.5 Total	Bio- CO2	NBio- CO2	Total CO2	CH4	N2O	CO2e
Category	lb/day										lb/day					
Fugitive Dust					19.6570	0.0000	19.6570	10.1025	0.0000	10.1025			0.0000			0.0000
Off-Road	3.1701	33.0835	19.6978	0.0380		1.6126	1.6126		1.4836	1.4836		3,686.0619	3,686.0619	1.1922		3,715.8655
<b>Total</b>	<b>3.1701</b>	<b>33.0835</b>	<b>19.6978</b>	<b>0.0380</b>	<b>19.6570</b>	<b>1.6126</b>	<b>21.2696</b>	<b>10.1025</b>	<b>1.4836</b>	<b>11.5860</b>		<b>3,686.0619</b>	<b>3,686.0619</b>	<b>1.1922</b>		<b>3,715.8655</b>

**Unmitigated Construction Off-Site**

	ROG	NOx	CO	SO2	Fugitive PM10	Exhaust PM10	PM10 Total	Fugitive PM2.5	Exhaust PM2.5	PM2.5 Total	Bio- CO2	NBio- CO2	Total CO2	CH4	N2O	CO2e
Category	lb/day										lb/day					
Hauling	0.0000	0.0000	0.0000	0.0000	0.0000	0.0000	0.0000	0.0000	0.0000	0.0000		0.0000	0.0000	0.0000	0.0000	0.0000
Vendor	0.0000	0.0000	0.0000	0.0000	0.0000	0.0000	0.0000	0.0000	0.0000	0.0000		0.0000	0.0000	0.0000	0.0000	0.0000
Worker	0.0713	0.0403	0.5679	1.4100e-003	0.1479	8.1000e-004	0.1487	0.0392	7.4000e-004	0.0400		142.5571	142.5571	4.3200e-003	3.8800e-003	143.8222
<b>Total</b>	<b>0.0713</b>	<b>0.0403</b>	<b>0.5679</b>	<b>1.4100e-003</b>	<b>0.1479</b>	<b>8.1000e-004</b>	<b>0.1487</b>	<b>0.0392</b>	<b>7.4000e-004</b>	<b>0.0400</b>		<b>142.5571</b>	<b>142.5571</b>	<b>4.3200e-003</b>	<b>3.8800e-003</b>	<b>143.8222</b>



Fresno County 18-Unit SFR Project - San Joaquin Valley Unified APCD Air District, Summer

**EMFAC Off-Model Adjustment Factors for Gasoline Light Duty Vehicle to Account for the SAFE Vehicle Rule Not Applied**

**3.3 Site Preparation - 2022**

**Mitigated Construction On-Site**

	ROG	NOx	CO	SO2	Fugitive PM10	Exhaust PM10	PM10 Total	Fugitive PM2.5	Exhaust PM2.5	PM2.5 Total	Bio- CO2	NBio- CO2	Total CO2	CH4	N2O	CO2e
Category	lb/day										lb/day					
Fugitive Dust					8.4034	0.0000	8.4034	4.3188	0.0000	4.3188			0.0000			0.0000
Off-Road	3.1701	33.0835	19.6978	0.0380		1.6126	1.6126		1.4836	1.4836	0.0000	3,686.0619	3,686.0619	1.1922		3,715.8655
<b>Total</b>	<b>3.1701</b>	<b>33.0835</b>	<b>19.6978</b>	<b>0.0380</b>	<b>8.4034</b>	<b>1.6126</b>	<b>10.0159</b>	<b>4.3188</b>	<b>1.4836</b>	<b>5.8024</b>	<b>0.0000</b>	<b>3,686.0619</b>	<b>3,686.0619</b>	<b>1.1922</b>		<b>3,715.8655</b>

**Mitigated Construction Off-Site**

	ROG	NOx	CO	SO2	Fugitive PM10	Exhaust PM10	PM10 Total	Fugitive PM2.5	Exhaust PM2.5	PM2.5 Total	Bio- CO2	NBio- CO2	Total CO2	CH4	N2O	CO2e
Category	lb/day										lb/day					
Hauling	0.0000	0.0000	0.0000	0.0000	0.0000	0.0000	0.0000	0.0000	0.0000	0.0000		0.0000	0.0000	0.0000	0.0000	0.0000
Vendor	0.0000	0.0000	0.0000	0.0000	0.0000	0.0000	0.0000	0.0000	0.0000	0.0000		0.0000	0.0000	0.0000	0.0000	0.0000
Worker	0.0713	0.0403	0.5679	1.4100e-003	0.1479	8.1000e-004	0.1487	0.0392	7.4000e-004	0.0400		142.5571	142.5571	4.3200e-003	3.8800e-003	143.8222
<b>Total</b>	<b>0.0713</b>	<b>0.0403</b>	<b>0.5679</b>	<b>1.4100e-003</b>	<b>0.1479</b>	<b>8.1000e-004</b>	<b>0.1487</b>	<b>0.0392</b>	<b>7.4000e-004</b>	<b>0.0400</b>		<b>142.5571</b>	<b>142.5571</b>	<b>4.3200e-003</b>	<b>3.8800e-003</b>	<b>143.8222</b>

Fresno County 18-Unit SFR Project - San Joaquin Valley Unified APCD Air District, Summer

**EMFAC Off-Model Adjustment Factors for Gasoline Light Duty Vehicle to Account for the SAFE Vehicle Rule Not Applied**

**3.4 Grading - 2022**

**Unmitigated Construction On-Site**

	ROG	NOx	CO	SO2	Fugitive PM10	Exhaust PM10	PM10 Total	Fugitive PM2.5	Exhaust PM2.5	PM2.5 Total	Bio- CO2	NBio- CO2	Total CO2	CH4	N2O	CO2e
Category	lb/day										lb/day					
Fugitive Dust					7.0826	0.0000	7.0826	3.4247	0.0000	3.4247			0.0000			0.0000
Off-Road	1.9486	20.8551	15.2727	0.0297		0.9409	0.9409		0.8656	0.8656		2,872.046 4	2,872.046 4	0.9289		2,895.268 4
<b>Total</b>	<b>1.9486</b>	<b>20.8551</b>	<b>15.2727</b>	<b>0.0297</b>	<b>7.0826</b>	<b>0.9409</b>	<b>8.0234</b>	<b>3.4247</b>	<b>0.8656</b>	<b>4.2903</b>		<b>2,872.046 4</b>	<b>2,872.046 4</b>	<b>0.9289</b>		<b>2,895.268 4</b>

**Unmitigated Construction Off-Site**

	ROG	NOx	CO	SO2	Fugitive PM10	Exhaust PM10	PM10 Total	Fugitive PM2.5	Exhaust PM2.5	PM2.5 Total	Bio- CO2	NBio- CO2	Total CO2	CH4	N2O	CO2e
Category	lb/day										lb/day					
Hauling	0.0000	0.0000	0.0000	0.0000	0.0000	0.0000	0.0000	0.0000	0.0000	0.0000		0.0000	0.0000	0.0000	0.0000	0.0000
Vendor	0.0000	0.0000	0.0000	0.0000	0.0000	0.0000	0.0000	0.0000	0.0000	0.0000		0.0000	0.0000	0.0000	0.0000	0.0000
Worker	0.0594	0.0336	0.4732	1.1800e-003	0.1232	6.7000e-004	0.1239	0.0327	6.2000e-004	0.0333		118.7976	118.7976	3.6000e-003	3.2400e-003	119.8518
<b>Total</b>	<b>0.0594</b>	<b>0.0336</b>	<b>0.4732</b>	<b>1.1800e-003</b>	<b>0.1232</b>	<b>6.7000e-004</b>	<b>0.1239</b>	<b>0.0327</b>	<b>6.2000e-004</b>	<b>0.0333</b>		<b>118.7976</b>	<b>118.7976</b>	<b>3.6000e-003</b>	<b>3.2400e-003</b>	<b>119.8518</b>

Fresno County 18-Unit SFR Project - San Joaquin Valley Unified APCD Air District, Summer

**EMFAC Off-Model Adjustment Factors for Gasoline Light Duty Vehicle to Account for the SAFE Vehicle Rule Not Applied**

**3.4 Grading - 2022**

**Mitigated Construction On-Site**

	ROG	NOx	CO	SO2	Fugitive PM10	Exhaust PM10	PM10 Total	Fugitive PM2.5	Exhaust PM2.5	PM2.5 Total	Bio- CO2	NBio- CO2	Total CO2	CH4	N2O	CO2e
Category	lb/day										lb/day					
Fugitive Dust					3.0278	0.0000	3.0278	1.4641	0.0000	1.4641			0.0000			0.0000
Off-Road	1.9486	20.8551	15.2727	0.0297		0.9409	0.9409		0.8656	0.8656	0.0000	2,872.046 4	2,872.046 4	0.9289		2,895.268 4
<b>Total</b>	<b>1.9486</b>	<b>20.8551</b>	<b>15.2727</b>	<b>0.0297</b>	<b>3.0278</b>	<b>0.9409</b>	<b>3.9687</b>	<b>1.4641</b>	<b>0.8656</b>	<b>2.3297</b>	<b>0.0000</b>	<b>2,872.046 4</b>	<b>2,872.046 4</b>	<b>0.9289</b>		<b>2,895.268 4</b>

**Mitigated Construction Off-Site**

	ROG	NOx	CO	SO2	Fugitive PM10	Exhaust PM10	PM10 Total	Fugitive PM2.5	Exhaust PM2.5	PM2.5 Total	Bio- CO2	NBio- CO2	Total CO2	CH4	N2O	CO2e
Category	lb/day										lb/day					
Hauling	0.0000	0.0000	0.0000	0.0000	0.0000	0.0000	0.0000	0.0000	0.0000	0.0000		0.0000	0.0000	0.0000	0.0000	0.0000
Vendor	0.0000	0.0000	0.0000	0.0000	0.0000	0.0000	0.0000	0.0000	0.0000	0.0000		0.0000	0.0000	0.0000	0.0000	0.0000
Worker	0.0594	0.0336	0.4732	1.1800e-003	0.1232	6.7000e-004	0.1239	0.0327	6.2000e-004	0.0333		118.7976	118.7976	3.6000e-003	3.2400e-003	119.8518
<b>Total</b>	<b>0.0594</b>	<b>0.0336</b>	<b>0.4732</b>	<b>1.1800e-003</b>	<b>0.1232</b>	<b>6.7000e-004</b>	<b>0.1239</b>	<b>0.0327</b>	<b>6.2000e-004</b>	<b>0.0333</b>		<b>118.7976</b>	<b>118.7976</b>	<b>3.6000e-003</b>	<b>3.2400e-003</b>	<b>119.8518</b>

Fresno County 18-Unit SFR Project - San Joaquin Valley Unified APCD Air District, Summer

**EMFAC Off-Model Adjustment Factors for Gasoline Light Duty Vehicle to Account for the SAFE Vehicle Rule Not Applied**

**3.5 Building Construction - 2022**

**Unmitigated Construction On-Site**

	ROG	NOx	CO	SO2	Fugitive PM10	Exhaust PM10	PM10 Total	Fugitive PM2.5	Exhaust PM2.5	PM2.5 Total	Bio- CO2	NBio- CO2	Total CO2	CH4	N2O	CO2e
Category	lb/day										lb/day					
Off-Road	1.7062	15.6156	16.3634	0.0269		0.8090	0.8090		0.7612	0.7612		2,554.3336	2,554.3336	0.6120		2,569.6322
<b>Total</b>	<b>1.7062</b>	<b>15.6156</b>	<b>16.3634</b>	<b>0.0269</b>		<b>0.8090</b>	<b>0.8090</b>		<b>0.7612</b>	<b>0.7612</b>		<b>2,554.3336</b>	<b>2,554.3336</b>	<b>0.6120</b>		<b>2,569.6322</b>

**Unmitigated Construction Off-Site**

	ROG	NOx	CO	SO2	Fugitive PM10	Exhaust PM10	PM10 Total	Fugitive PM2.5	Exhaust PM2.5	PM2.5 Total	Bio- CO2	NBio- CO2	Total CO2	CH4	N2O	CO2e
Category	lb/day										lb/day					
Hauling	0.0000	0.0000	0.0000	0.0000	0.0000	0.0000	0.0000	0.0000	0.0000	0.0000		0.0000	0.0000	0.0000	0.0000	0.0000
Vendor	4.4000e-003	0.1050	0.0311	4.2000e-004	0.0136	1.2200e-003	0.0148	3.9000e-003	1.1700e-003	5.0700e-003		44.2529	44.2529	2.9000e-004	6.6300e-003	46.2361
Worker	0.0238	0.0134	0.1893	4.7000e-004	0.0493	2.7000e-004	0.0496	0.0131	2.5000e-004	0.0133		47.5191	47.5191	1.4400e-003	1.2900e-003	47.9407
<b>Total</b>	<b>0.0282</b>	<b>0.1184</b>	<b>0.2204</b>	<b>8.9000e-004</b>	<b>0.0629</b>	<b>1.4900e-003</b>	<b>0.0643</b>	<b>0.0170</b>	<b>1.4200e-003</b>	<b>0.0184</b>		<b>91.7720</b>	<b>91.7720</b>	<b>1.7300e-003</b>	<b>7.9200e-003</b>	<b>94.1768</b>

Fresno County 18-Unit SFR Project - San Joaquin Valley Unified APCD Air District, Summer

**EMFAC Off-Model Adjustment Factors for Gasoline Light Duty Vehicle to Account for the SAFE Vehicle Rule Not Applied**

**3.5 Building Construction - 2022**

**Mitigated Construction On-Site**

	ROG	NOx	CO	SO2	Fugitive PM10	Exhaust PM10	PM10 Total	Fugitive PM2.5	Exhaust PM2.5	PM2.5 Total	Bio- CO2	NBio- CO2	Total CO2	CH4	N2O	CO2e
Category	lb/day										lb/day					
Off-Road	1.7062	15.6156	16.3634	0.0269		0.8090	0.8090		0.7612	0.7612	0.0000	2,554.3336	2,554.3336	0.6120		2,569.6322
<b>Total</b>	<b>1.7062</b>	<b>15.6156</b>	<b>16.3634</b>	<b>0.0269</b>		<b>0.8090</b>	<b>0.8090</b>		<b>0.7612</b>	<b>0.7612</b>	<b>0.0000</b>	<b>2,554.3336</b>	<b>2,554.3336</b>	<b>0.6120</b>		<b>2,569.6322</b>

**Mitigated Construction Off-Site**

	ROG	NOx	CO	SO2	Fugitive PM10	Exhaust PM10	PM10 Total	Fugitive PM2.5	Exhaust PM2.5	PM2.5 Total	Bio- CO2	NBio- CO2	Total CO2	CH4	N2O	CO2e
Category	lb/day										lb/day					
Hauling	0.0000	0.0000	0.0000	0.0000	0.0000	0.0000	0.0000	0.0000	0.0000	0.0000		0.0000	0.0000	0.0000	0.0000	0.0000
Vendor	4.4000e-003	0.1050	0.0311	4.2000e-004	0.0136	1.2200e-003	0.0148	3.9000e-003	1.1700e-003	5.0700e-003		44.2529	44.2529	2.9000e-004	6.6300e-003	46.2361
Worker	0.0238	0.0134	0.1893	4.7000e-004	0.0493	2.7000e-004	0.0496	0.0131	2.5000e-004	0.0133		47.5191	47.5191	1.4400e-003	1.2900e-003	47.9407
<b>Total</b>	<b>0.0282</b>	<b>0.1184</b>	<b>0.2204</b>	<b>8.9000e-004</b>	<b>0.0629</b>	<b>1.4900e-003</b>	<b>0.0643</b>	<b>0.0170</b>	<b>1.4200e-003</b>	<b>0.0184</b>		<b>91.7720</b>	<b>91.7720</b>	<b>1.7300e-003</b>	<b>7.9200e-003</b>	<b>94.1768</b>

Fresno County 18-Unit SFR Project - San Joaquin Valley Unified APCD Air District, Summer

**EMFAC Off-Model Adjustment Factors for Gasoline Light Duty Vehicle to Account for the SAFE Vehicle Rule Not Applied**

**3.5 Building Construction - 2023**

**Unmitigated Construction On-Site**

	ROG	NOx	CO	SO2	Fugitive PM10	Exhaust PM10	PM10 Total	Fugitive PM2.5	Exhaust PM2.5	PM2.5 Total	Bio- CO2	NBio- CO2	Total CO2	CH4	N2O	CO2e
Category	lb/day										lb/day					
Off-Road	1.5728	14.3849	16.2440	0.0269		0.6997	0.6997		0.6584	0.6584		2,555.2099	2,555.2099	0.6079		2,570.4061
<b>Total</b>	<b>1.5728</b>	<b>14.3849</b>	<b>16.2440</b>	<b>0.0269</b>		<b>0.6997</b>	<b>0.6997</b>		<b>0.6584</b>	<b>0.6584</b>		<b>2,555.2099</b>	<b>2,555.2099</b>	<b>0.6079</b>		<b>2,570.4061</b>

**Unmitigated Construction Off-Site**

	ROG	NOx	CO	SO2	Fugitive PM10	Exhaust PM10	PM10 Total	Fugitive PM2.5	Exhaust PM2.5	PM2.5 Total	Bio- CO2	NBio- CO2	Total CO2	CH4	N2O	CO2e
Category	lb/day										lb/day					
Hauling	0.0000	0.0000	0.0000	0.0000	0.0000	0.0000	0.0000	0.0000	0.0000	0.0000		0.0000	0.0000	0.0000	0.0000	0.0000
Vendor	2.2800e-003	0.0845	0.0267	4.0000e-004	0.0136	5.7000e-004	0.0141	3.9000e-003	5.5000e-004	4.4500e-003		42.5841	42.5841	1.8000e-004	6.3700e-003	44.4864
Worker	0.0218	0.0117	0.1720	4.5000e-004	0.0493	2.5000e-004	0.0495	0.0131	2.3000e-004	0.0133		45.9808	45.9808	1.2800e-003	1.1900e-003	46.3667
<b>Total</b>	<b>0.0240</b>	<b>0.0963</b>	<b>0.1987</b>	<b>8.5000e-004</b>	<b>0.0629</b>	<b>8.2000e-004</b>	<b>0.0637</b>	<b>0.0170</b>	<b>7.8000e-004</b>	<b>0.0178</b>		<b>88.5649</b>	<b>88.5649</b>	<b>1.4600e-003</b>	<b>7.5600e-003</b>	<b>90.8531</b>

Fresno County 18-Unit SFR Project - San Joaquin Valley Unified APCD Air District, Summer

**EMFAC Off-Model Adjustment Factors for Gasoline Light Duty Vehicle to Account for the SAFE Vehicle Rule Not Applied**

**3.5 Building Construction - 2023**

**Mitigated Construction On-Site**

	ROG	NOx	CO	SO2	Fugitive PM10	Exhaust PM10	PM10 Total	Fugitive PM2.5	Exhaust PM2.5	PM2.5 Total	Bio- CO2	NBio- CO2	Total CO2	CH4	N2O	CO2e
Category	lb/day										lb/day					
Off-Road	1.5728	14.3849	16.2440	0.0269		0.6997	0.6997		0.6584	0.6584	0.0000	2,555.2099	2,555.2099	0.6079		2,570.4061
<b>Total</b>	<b>1.5728</b>	<b>14.3849</b>	<b>16.2440</b>	<b>0.0269</b>		<b>0.6997</b>	<b>0.6997</b>		<b>0.6584</b>	<b>0.6584</b>	<b>0.0000</b>	<b>2,555.2099</b>	<b>2,555.2099</b>	<b>0.6079</b>		<b>2,570.4061</b>

**Mitigated Construction Off-Site**

	ROG	NOx	CO	SO2	Fugitive PM10	Exhaust PM10	PM10 Total	Fugitive PM2.5	Exhaust PM2.5	PM2.5 Total	Bio- CO2	NBio- CO2	Total CO2	CH4	N2O	CO2e
Category	lb/day										lb/day					
Hauling	0.0000	0.0000	0.0000	0.0000	0.0000	0.0000	0.0000	0.0000	0.0000	0.0000		0.0000	0.0000	0.0000	0.0000	0.0000
Vendor	2.2800e-003	0.0845	0.0267	4.0000e-004	0.0136	5.7000e-004	0.0141	3.9000e-003	5.5000e-004	4.4500e-003		42.5841	42.5841	1.8000e-004	6.3700e-003	44.4864
Worker	0.0218	0.0117	0.1720	4.5000e-004	0.0493	2.5000e-004	0.0495	0.0131	2.3000e-004	0.0133		45.9808	45.9808	1.2800e-003	1.1900e-003	46.3667
<b>Total</b>	<b>0.0240</b>	<b>0.0963</b>	<b>0.1987</b>	<b>8.5000e-004</b>	<b>0.0629</b>	<b>8.2000e-004</b>	<b>0.0637</b>	<b>0.0170</b>	<b>7.8000e-004</b>	<b>0.0178</b>		<b>88.5649</b>	<b>88.5649</b>	<b>1.4600e-003</b>	<b>7.5600e-003</b>	<b>90.8531</b>



Fresno County 18-Unit SFR Project - San Joaquin Valley Unified APCD Air District, Summer

**EMFAC Off-Model Adjustment Factors for Gasoline Light Duty Vehicle to Account for the SAFE Vehicle Rule Not Applied**

**3.6 Paving - 2023**

**Unmitigated Construction On-Site**

	ROG	NOx	CO	SO2	Fugitive PM10	Exhaust PM10	PM10 Total	Fugitive PM2.5	Exhaust PM2.5	PM2.5 Total	Bio- CO2	NBio- CO2	Total CO2	CH4	N2O	CO2e
Category	lb/day										lb/day					
Off-Road	1.0327	10.1917	14.5842	0.0228		0.5102	0.5102		0.4694	0.4694		2,207.5841	2,207.5841	0.7140		2,225.4336
Paving	0.0000					0.0000	0.0000		0.0000	0.0000			0.0000			0.0000
<b>Total</b>	<b>1.0327</b>	<b>10.1917</b>	<b>14.5842</b>	<b>0.0228</b>		<b>0.5102</b>	<b>0.5102</b>		<b>0.4694</b>	<b>0.4694</b>		<b>2,207.5841</b>	<b>2,207.5841</b>	<b>0.7140</b>		<b>2,225.4336</b>

**Unmitigated Construction Off-Site**

	ROG	NOx	CO	SO2	Fugitive PM10	Exhaust PM10	PM10 Total	Fugitive PM2.5	Exhaust PM2.5	PM2.5 Total	Bio- CO2	NBio- CO2	Total CO2	CH4	N2O	CO2e
Category	lb/day										lb/day					
Hauling	0.0000	0.0000	0.0000	0.0000	0.0000	0.0000	0.0000	0.0000	0.0000	0.0000		0.0000	0.0000	0.0000	0.0000	0.0000
Vendor	0.0000	0.0000	0.0000	0.0000	0.0000	0.0000	0.0000	0.0000	0.0000	0.0000		0.0000	0.0000	0.0000	0.0000	0.0000
Worker	0.0544	0.0294	0.4301	1.1400e-003	0.1232	6.3000e-004	0.1239	0.0327	5.8000e-004	0.0333		114.9519	114.9519	3.2100e-003	2.9700e-003	115.9168
<b>Total</b>	<b>0.0544</b>	<b>0.0294</b>	<b>0.4301</b>	<b>1.1400e-003</b>	<b>0.1232</b>	<b>6.3000e-004</b>	<b>0.1239</b>	<b>0.0327</b>	<b>5.8000e-004</b>	<b>0.0333</b>		<b>114.9519</b>	<b>114.9519</b>	<b>3.2100e-003</b>	<b>2.9700e-003</b>	<b>115.9168</b>

Fresno County 18-Unit SFR Project - San Joaquin Valley Unified APCD Air District, Summer

**EMFAC Off-Model Adjustment Factors for Gasoline Light Duty Vehicle to Account for the SAFE Vehicle Rule Not Applied**

**3.6 Paving - 2023**

**Mitigated Construction On-Site**

	ROG	NOx	CO	SO2	Fugitive PM10	Exhaust PM10	PM10 Total	Fugitive PM2.5	Exhaust PM2.5	PM2.5 Total	Bio- CO2	NBio- CO2	Total CO2	CH4	N2O	CO2e
Category	lb/day										lb/day					
Off-Road	1.0327	10.1917	14.5842	0.0228		0.5102	0.5102		0.4694	0.4694	0.0000	2,207.5841	2,207.5841	0.7140		2,225.4336
Paving	0.0000					0.0000	0.0000		0.0000	0.0000			0.0000			0.0000
<b>Total</b>	<b>1.0327</b>	<b>10.1917</b>	<b>14.5842</b>	<b>0.0228</b>		<b>0.5102</b>	<b>0.5102</b>		<b>0.4694</b>	<b>0.4694</b>	<b>0.0000</b>	<b>2,207.5841</b>	<b>2,207.5841</b>	<b>0.7140</b>		<b>2,225.4336</b>

**Mitigated Construction Off-Site**

	ROG	NOx	CO	SO2	Fugitive PM10	Exhaust PM10	PM10 Total	Fugitive PM2.5	Exhaust PM2.5	PM2.5 Total	Bio- CO2	NBio- CO2	Total CO2	CH4	N2O	CO2e
Category	lb/day										lb/day					
Hauling	0.0000	0.0000	0.0000	0.0000	0.0000	0.0000	0.0000	0.0000	0.0000	0.0000		0.0000	0.0000	0.0000	0.0000	0.0000
Vendor	0.0000	0.0000	0.0000	0.0000	0.0000	0.0000	0.0000	0.0000	0.0000	0.0000		0.0000	0.0000	0.0000	0.0000	0.0000
Worker	0.0544	0.0294	0.4301	1.1400e-003	0.1232	6.3000e-004	0.1239	0.0327	5.8000e-004	0.0333		114.9519	114.9519	3.2100e-003	2.9700e-003	115.9168
<b>Total</b>	<b>0.0544</b>	<b>0.0294</b>	<b>0.4301</b>	<b>1.1400e-003</b>	<b>0.1232</b>	<b>6.3000e-004</b>	<b>0.1239</b>	<b>0.0327</b>	<b>5.8000e-004</b>	<b>0.0333</b>		<b>114.9519</b>	<b>114.9519</b>	<b>3.2100e-003</b>	<b>2.9700e-003</b>	<b>115.9168</b>

Fresno County 18-Unit SFR Project - San Joaquin Valley Unified APCD Air District, Summer

**EMFAC Off-Model Adjustment Factors for Gasoline Light Duty Vehicle to Account for the SAFE Vehicle Rule Not Applied**

**3.7 Architectural Coating - 2023**

**Unmitigated Construction On-Site**

	ROG	NOx	CO	SO2	Fugitive PM10	Exhaust PM10	PM10 Total	Fugitive PM2.5	Exhaust PM2.5	PM2.5 Total	Bio- CO2	NBio- CO2	Total CO2	CH4	N2O	CO2e
Category	lb/day										lb/day					
Archit. Coating	30.4102					0.0000	0.0000		0.0000	0.0000			0.0000			0.0000
Off-Road	0.1917	1.3030	1.8111	2.9700e-003		0.0708	0.0708		0.0708	0.0708		281.4481	281.4481	0.0168		281.8690
<b>Total</b>	<b>30.6019</b>	<b>1.3030</b>	<b>1.8111</b>	<b>2.9700e-003</b>		<b>0.0708</b>	<b>0.0708</b>		<b>0.0708</b>	<b>0.0708</b>		<b>281.4481</b>	<b>281.4481</b>	<b>0.0168</b>		<b>281.8690</b>

**Unmitigated Construction Off-Site**

	ROG	NOx	CO	SO2	Fugitive PM10	Exhaust PM10	PM10 Total	Fugitive PM2.5	Exhaust PM2.5	PM2.5 Total	Bio- CO2	NBio- CO2	Total CO2	CH4	N2O	CO2e
Category	lb/day										lb/day					
Hauling	0.0000	0.0000	0.0000	0.0000	0.0000	0.0000	0.0000	0.0000	0.0000	0.0000		0.0000	0.0000	0.0000	0.0000	0.0000
Vendor	0.0000	0.0000	0.0000	0.0000	0.0000	0.0000	0.0000	0.0000	0.0000	0.0000		0.0000	0.0000	0.0000	0.0000	0.0000
Worker	3.6300e-003	1.9600e-003	0.0287	8.0000e-005	8.2100e-003	4.0000e-005	8.2600e-003	2.1800e-003	4.0000e-005	2.2200e-003		7.6635	7.6635	2.1000e-004	2.0000e-004	7.7278
<b>Total</b>	<b>3.6300e-003</b>	<b>1.9600e-003</b>	<b>0.0287</b>	<b>8.0000e-005</b>	<b>8.2100e-003</b>	<b>4.0000e-005</b>	<b>8.2600e-003</b>	<b>2.1800e-003</b>	<b>4.0000e-005</b>	<b>2.2200e-003</b>		<b>7.6635</b>	<b>7.6635</b>	<b>2.1000e-004</b>	<b>2.0000e-004</b>	<b>7.7278</b>

Fresno County 18-Unit SFR Project - San Joaquin Valley Unified APCD Air District, Summer

**EMFAC Off-Model Adjustment Factors for Gasoline Light Duty Vehicle to Account for the SAFE Vehicle Rule Not Applied**

**3.7 Architectural Coating - 2023**

**Mitigated Construction On-Site**

	ROG	NOx	CO	SO2	Fugitive PM10	Exhaust PM10	PM10 Total	Fugitive PM2.5	Exhaust PM2.5	PM2.5 Total	Bio- CO2	NBio- CO2	Total CO2	CH4	N2O	CO2e
Category	lb/day										lb/day					
Archit. Coating	30.4102					0.0000	0.0000		0.0000	0.0000			0.0000			0.0000
Off-Road	0.1917	1.3030	1.8111	2.9700e-003		0.0708	0.0708		0.0708	0.0708	0.0000	281.4481	281.4481	0.0168		281.8690
<b>Total</b>	<b>30.6019</b>	<b>1.3030</b>	<b>1.8111</b>	<b>2.9700e-003</b>		<b>0.0708</b>	<b>0.0708</b>		<b>0.0708</b>	<b>0.0708</b>	<b>0.0000</b>	<b>281.4481</b>	<b>281.4481</b>	<b>0.0168</b>		<b>281.8690</b>

**Mitigated Construction Off-Site**

	ROG	NOx	CO	SO2	Fugitive PM10	Exhaust PM10	PM10 Total	Fugitive PM2.5	Exhaust PM2.5	PM2.5 Total	Bio- CO2	NBio- CO2	Total CO2	CH4	N2O	CO2e
Category	lb/day										lb/day					
Hauling	0.0000	0.0000	0.0000	0.0000	0.0000	0.0000	0.0000	0.0000	0.0000	0.0000		0.0000	0.0000	0.0000	0.0000	0.0000
Vendor	0.0000	0.0000	0.0000	0.0000	0.0000	0.0000	0.0000	0.0000	0.0000	0.0000		0.0000	0.0000	0.0000	0.0000	0.0000
Worker	3.6300e-003	1.9600e-003	0.0287	8.0000e-005	8.2100e-003	4.0000e-005	8.2600e-003	2.1800e-003	4.0000e-005	2.2200e-003		7.6635	7.6635	2.1000e-004	2.0000e-004	7.7278
<b>Total</b>	<b>3.6300e-003</b>	<b>1.9600e-003</b>	<b>0.0287</b>	<b>8.0000e-005</b>	<b>8.2100e-003</b>	<b>4.0000e-005</b>	<b>8.2600e-003</b>	<b>2.1800e-003</b>	<b>4.0000e-005</b>	<b>2.2200e-003</b>		<b>7.6635</b>	<b>7.6635</b>	<b>2.1000e-004</b>	<b>2.0000e-004</b>	<b>7.7278</b>

Fresno County 18-Unit SFR Project - San Joaquin Valley Unified APCD Air District, Summer

EMFAC Off-Model Adjustment Factors for Gasoline Light Duty Vehicle to Account for the SAFE Vehicle Rule Not Applied

4.0 Operational Detail - Mobile

4.1 Mitigation Measures Mobile

	ROG	NOx	CO	SO2	Fugitive PM10	Exhaust PM10	PM10 Total	Fugitive PM2.5	Exhaust PM2.5	PM2.5 Total	Bio- CO2	NBio- CO2	Total CO2	CH4	N2O	CO2e
Category	lb/day										lb/day					
Mitigated	0.5712	0.8017	4.8232	0.0114	1.0539	9.6000e-003	1.0635	0.2815	9.0100e-003	0.2905		1,160.648 1	1,160.648 1	0.0557	0.0603	1,180.009 3
Unmitigated	0.5712	0.8017	4.8232	0.0114	1.0539	9.6000e-003	1.0635	0.2815	9.0100e-003	0.2905		1,160.648 1	1,160.648 1	0.0557	0.0603	1,180.009 3

4.2 Trip Summary Information

Land Use	Average Daily Trip Rate			Unmitigated	Mitigated
	Weekday	Saturday	Sunday	Annual VMT	Annual VMT
Single Family Housing	169.92	171.72	153.90	486,510	486,510
Total	169.92	171.72	153.90	486,510	486,510

4.3 Trip Type Information

Land Use	Miles			Trip %			Trip Purpose %		
	H-W or C-W	H-S or C-C	H-O or C-NW	H-W or C-W	H-S or C-C	H-O or C-NW	Primary	Diverted	Pass-by
Single Family Housing	10.80	7.30	7.50	45.60	19.00	35.40	86	11	3

4.4 Fleet Mix

Land Use	LDA	LDT1	LDT2	MDV	LHD1	LHD2	MHD	HHD	OBUS	UBUS	MCY	SBUS	MH
Single Family Housing	0.511221	0.052103	0.170611	0.160645	0.028932	0.007649	0.013284	0.025916	0.000654	0.000315	0.023645	0.001472	0.003552

Fresno County 18-Unit SFR Project - San Joaquin Valley Unified APCD Air District, Summer

**EMFAC Off-Model Adjustment Factors for Gasoline Light Duty Vehicle to Account for the SAFE Vehicle Rule Not Applied**

**5.0 Energy Detail**

Historical Energy Use: N

**5.1 Mitigation Measures Energy**

	ROG	NOx	CO	SO2	Fugitive PM10	Exhaust PM10	PM10 Total	Fugitive PM2.5	Exhaust PM2.5	PM2.5 Total	Bio- CO2	NBio- CO2	Total CO2	CH4	N2O	CO2e
Category	lb/day										lb/day					
NaturalGas Mitigated	0.0126	0.1080	0.0460	6.9000e-004		8.7300e-003	8.7300e-003		8.7300e-003	8.7300e-003		137.8676	137.8676	2.6400e-003	2.5300e-003	138.6869
NaturalGas Unmitigated	0.0126	0.1080	0.0460	6.9000e-004		8.7300e-003	8.7300e-003		8.7300e-003	8.7300e-003		137.8676	137.8676	2.6400e-003	2.5300e-003	138.6869

**5.2 Energy by Land Use - NaturalGas**

**Unmitigated**

	NaturalGas Use	ROG	NOx	CO	SO2	Fugitive PM10	Exhaust PM10	PM10 Total	Fugitive PM2.5	Exhaust PM2.5	PM2.5 Total	Bio- CO2	NBio- CO2	Total CO2	CH4	N2O	CO2e
Land Use	kBTU/yr	lb/day										lb/day					
Single Family Housing	1171.87	0.0126	0.1080	0.0460	6.9000e-004		8.7300e-003	8.7300e-003		8.7300e-003	8.7300e-003		137.8676	137.8676	2.6400e-003	2.5300e-003	138.6869
<b>Total</b>		<b>0.0126</b>	<b>0.1080</b>	<b>0.0460</b>	<b>6.9000e-004</b>		<b>8.7300e-003</b>	<b>8.7300e-003</b>		<b>8.7300e-003</b>	<b>8.7300e-003</b>		<b>137.8676</b>	<b>137.8676</b>	<b>2.6400e-003</b>	<b>2.5300e-003</b>	<b>138.6869</b>

Fresno County 18-Unit SFR Project - San Joaquin Valley Unified APCD Air District, Summer

**EMFAC Off-Model Adjustment Factors for Gasoline Light Duty Vehicle to Account for the SAFE Vehicle Rule Not Applied**

**5.2 Energy by Land Use - NaturalGas**

Mitigated

	NaturalGas Use	ROG	NOx	CO	SO2	Fugitive PM10	Exhaust PM10	PM10 Total	Fugitive PM2.5	Exhaust PM2.5	PM2.5 Total	Bio- CO2	NBio- CO2	Total CO2	CH4	N2O	CO2e
Land Use	kBTU/yr	lb/day										lb/day					
Single Family Housing	1.17187	0.0126	0.1080	0.0460	6.9000e-004		8.7300e-003	8.7300e-003		8.7300e-003	8.7300e-003		137.8676	137.8676	2.6400e-003	2.5300e-003	138.6869
<b>Total</b>		<b>0.0126</b>	<b>0.1080</b>	<b>0.0460</b>	<b>6.9000e-004</b>		<b>8.7300e-003</b>	<b>8.7300e-003</b>		<b>8.7300e-003</b>	<b>8.7300e-003</b>		<b>137.8676</b>	<b>137.8676</b>	<b>2.6400e-003</b>	<b>2.5300e-003</b>	<b>138.6869</b>

**6.0 Area Detail**

**6.1 Mitigation Measures Area**

	ROG	NOx	CO	SO2	Fugitive PM10	Exhaust PM10	PM10 Total	Fugitive PM2.5	Exhaust PM2.5	PM2.5 Total	Bio- CO2	NBio- CO2	Total CO2	CH4	N2O	CO2e
Category	lb/day										lb/day					
Mitigated	0.9238	0.1813	1.5543	1.1300e-003		0.0215	0.0215		0.0215	0.0215	0.0000	212.3210	212.3210	6.5800e-003	3.8400e-003	213.6310
Unmitigated	0.9238	0.1813	1.5543	1.1300e-003		0.0215	0.0215		0.0215	0.0215	0.0000	212.3210	212.3210	6.5800e-003	3.8400e-003	213.6310

Fresno County 18-Unit SFR Project - San Joaquin Valley Unified APCD Air District, Summer

**EMFAC Off-Model Adjustment Factors for Gasoline Light Duty Vehicle to Account for the SAFE Vehicle Rule Not Applied**

**6.2 Area by SubCategory**

**Unmitigated**

	ROG	NOx	CO	SO2	Fugitive PM10	Exhaust PM10	PM10 Total	Fugitive PM2.5	Exhaust PM2.5	PM2.5 Total	Bio- CO2	NBio- CO2	Total CO2	CH4	N2O	CO2e
SubCategory	lb/day										lb/day					
Architectural Coating	0.1666					0.0000	0.0000		0.0000	0.0000			0.0000			0.0000
Consumer Products	0.6934					0.0000	0.0000		0.0000	0.0000			0.0000			0.0000
Hearth	0.0192	0.1642	0.0699	1.0500e-003		0.0133	0.0133		0.0133	0.0133	0.0000	209.6471	209.6471	4.0200e-003	3.8400e-003	210.8929
Landscaping	0.0446	0.0171	1.4844	8.0000e-005		8.2300e-003	8.2300e-003		8.2300e-003	8.2300e-003		2.6739	2.6739	2.5700e-003		2.7381
<b>Total</b>	<b>0.9238</b>	<b>0.1813</b>	<b>1.5543</b>	<b>1.1300e-003</b>		<b>0.0215</b>	<b>0.0215</b>		<b>0.0215</b>	<b>0.0215</b>	<b>0.0000</b>	<b>212.3210</b>	<b>212.3210</b>	<b>6.5900e-003</b>	<b>3.8400e-003</b>	<b>213.6310</b>



Fresno County 18-Unit SFR Project - San Joaquin Valley Unified APCD Air District, Summer

**EMFAC Off-Model Adjustment Factors for Gasoline Light Duty Vehicle to Account for the SAFE Vehicle Rule Not Applied**

**6.2 Area by SubCategory**

Mitigated

	ROG	NOx	CO	SO2	Fugitive PM10	Exhaust PM10	PM10 Total	Fugitive PM2.5	Exhaust PM2.5	PM2.5 Total	Bio- CO2	NBio- CO2	Total CO2	CH4	N2O	CO2e
SubCategory	lb/day										lb/day					
Architectural Coating	0.1666					0.0000	0.0000		0.0000	0.0000			0.0000			0.0000
Consumer Products	0.6934					0.0000	0.0000		0.0000	0.0000			0.0000			0.0000
Hearth	0.0192	0.1642	0.0699	1.0500e-003		0.0133	0.0133		0.0133	0.0133	0.0000	209.6471	209.6471	4.0200e-003	3.8400e-003	210.8929
Landscaping	0.0446	0.0171	1.4844	8.0000e-005		8.2300e-003	8.2300e-003		8.2300e-003	8.2300e-003		2.6739	2.6739	2.5700e-003		2.7381
<b>Total</b>	<b>0.9238</b>	<b>0.1813</b>	<b>1.5543</b>	<b>1.1300e-003</b>		<b>0.0215</b>	<b>0.0215</b>		<b>0.0215</b>	<b>0.0215</b>	<b>0.0000</b>	<b>212.3210</b>	<b>212.3210</b>	<b>6.5900e-003</b>	<b>3.8400e-003</b>	<b>213.6310</b>

**7.0 Water Detail**

**7.1 Mitigation Measures Water**

Fresno County 18-Unit SFR Project - San Joaquin Valley Unified APCD Air District, Summer

**EMFAC Off-Model Adjustment Factors for Gasoline Light Duty Vehicle to Account for the SAFE Vehicle Rule Not Applied**

**8.0 Waste Detail**

---

**8.1 Mitigation Measures Waste**

**9.0 Operational Offroad**

---

Equipment Type	Number	Hours/Day	Days/Year	Horse Power	Load Factor	Fuel Type
----------------	--------	-----------	-----------	-------------	-------------	-----------

**10.0 Stationary Equipment**

---

**Fire Pumps and Emergency Generators**

Equipment Type	Number	Hours/Day	Hours/Year	Horse Power	Load Factor	Fuel Type
----------------	--------	-----------	------------	-------------	-------------	-----------

**Boilers**

Equipment Type	Number	Heat Input/Day	Heat Input/Year	Boiler Rating	Fuel Type
----------------	--------	----------------	-----------------	---------------	-----------

**User Defined Equipment**

Equipment Type	Number
----------------	--------

**11.0 Vegetation**

---

Fresno County 18-Unit SFR Project - San Joaquin Valley Unified APCD Air District, Winter

**EMFAC Off-Model Adjustment Factors for Gasoline Light Duty Vehicle to Account for the SAFE Vehicle Rule Not Applied**

**Fresno County 18-Unit SFR Project**  
**San Joaquin Valley Unified APCD Air District, Winter**

**1.0 Project Characteristics**

---

**1.1 Land Usage**

Land Uses	Size	Metric	Lot Acreage	Floor Surface Area	Population
Single Family Housing	18.00	Dwelling Unit	5.84	32,400.00	57

**1.2 Other Project Characteristics**

<b>Urbanization</b>	Urban	<b>Wind Speed (m/s)</b>	2.7	<b>Precipitation Freq (Days)</b>	45
<b>Climate Zone</b>	7			<b>Operational Year</b>	2024
<b>Utility Company</b>	Pacific Gas and Electric Company				
<b>CO2 Intensity (lb/MWhr)</b>	203.98	<b>CH4 Intensity (lb/MWhr)</b>	0.033	<b>N2O Intensity (lb/MWhr)</b>	0.004

**1.3 User Entered Comments & Non-Default Data**

Project Characteristics -

Land Use -

Construction Off-road Equipment Mitigation -

Table Name	Column Name	Default Value	New Value
tblWoodstoves	NumberCatalytic	5.84	0.00
tblWoodstoves	NumberNoncatalytic	5.84	0.00

**2.0 Emissions Summary**

---

Fresno County 18-Unit SFR Project - San Joaquin Valley Unified APCD Air District, Winter

**EMFAC Off-Model Adjustment Factors for Gasoline Light Duty Vehicle to Account for the SAFE Vehicle Rule Not Applied**

**2.1 Overall Construction (Maximum Daily Emission)**

**Unmitigated Construction**

	ROG	NOx	CO	SO2	Fugitive PM10	Exhaust PM10	PM10 Total	Fugitive PM2.5	Exhaust PM2.5	PM2.5 Total	Bio- CO2	NBio- CO2	Total CO2	CH4	N2O	CO2e
Year	lb/day										lb/day					
2022	3.2336	33.1311	20.9970	0.0399	19.8049	1.6134	21.4183	10.1417	1.4843	11.6260	0.0000	3,852.4480	3,852.4480	1.1969	8.0900e-003	3,879.9362
2023	30.6051	14.4893	16.4189	0.0277	0.1232	0.7006	0.7634	0.0327	0.6592	0.6762	0.0000	2,638.7915	2,638.7915	0.7176	7.7200e-003	2,656.3263
<b>Maximum</b>	<b>30.6051</b>	<b>33.1311</b>	<b>20.9970</b>	<b>0.0399</b>	<b>19.8049</b>	<b>1.6134</b>	<b>21.4183</b>	<b>10.1417</b>	<b>1.4843</b>	<b>11.6260</b>	<b>0.0000</b>	<b>3,852.4480</b>	<b>3,852.4480</b>	<b>1.1969</b>	<b>8.0900e-003</b>	<b>3,879.9362</b>

**Mitigated Construction**

	ROG	NOx	CO	SO2	Fugitive PM10	Exhaust PM10	PM10 Total	Fugitive PM2.5	Exhaust PM2.5	PM2.5 Total	Bio- CO2	NBio- CO2	Total CO2	CH4	N2O	CO2e
Year	lb/day										lb/day					
2022	3.2336	33.1311	20.9970	0.0399	8.5512	1.6134	10.1646	4.3580	1.4843	5.8423	0.0000	3,852.4480	3,852.4480	1.1969	8.0900e-003	3,879.9362
2023	30.6051	14.4893	16.4189	0.0277	0.1232	0.7006	0.7634	0.0327	0.6592	0.6762	0.0000	2,638.7915	2,638.7915	0.7176	7.7200e-003	2,656.3263
<b>Maximum</b>	<b>30.6051</b>	<b>33.1311</b>	<b>20.9970</b>	<b>0.0399</b>	<b>8.5512</b>	<b>1.6134</b>	<b>10.1646</b>	<b>4.3580</b>	<b>1.4843</b>	<b>5.8423</b>	<b>0.0000</b>	<b>3,852.4480</b>	<b>3,852.4480</b>	<b>1.1969</b>	<b>8.0900e-003</b>	<b>3,879.9362</b>

## Fresno County 18-Unit SFR Project - San Joaquin Valley Unified APCD Air District, Winter

**EMFAC Off-Model Adjustment Factors for Gasoline Light Duty Vehicle to Account for the SAFE Vehicle Rule Not Applied**

	ROG	NOx	CO	SO2	Fugitive PM10	Exhaust PM10	PM10 Total	Fugitive PM2.5	Exhaust PM2.5	PM2.5 Total	Bio- CO2	NBio-CO2	Total CO2	CH4	N2O	CO2e
Percent Reduction	0.00	0.00	0.00	0.00	56.47	0.00	50.73	56.85	0.00	47.01	0.00	0.00	0.00	0.00	0.00	0.00

Fresno County 18-Unit SFR Project - San Joaquin Valley Unified APCD Air District, Winter

**EMFAC Off-Model Adjustment Factors for Gasoline Light Duty Vehicle to Account for the SAFE Vehicle Rule Not Applied**

**2.2 Overall Operational**

**Unmitigated Operational**

	ROG	NOx	CO	SO2	Fugitive PM10	Exhaust PM10	PM10 Total	Fugitive PM2.5	Exhaust PM2.5	PM2.5 Total	Bio- CO2	NBio- CO2	Total CO2	CH4	N2O	CO2e
Category	lb/day										lb/day					
Area	0.9238	0.1813	1.5543	1.1300e-003		0.0215	0.0215		0.0215	0.0215	0.0000	212.3210	212.3210	6.5800e-003	3.8400e-003	213.6310
Energy	0.0126	0.1080	0.0460	6.9000e-004		8.7300e-003	8.7300e-003		8.7300e-003	8.7300e-003		137.8676	137.8676	2.6400e-003	2.5300e-003	138.6869
Mobile	0.4552	0.8961	4.6562	0.0105	1.0539	9.6000e-003	1.0635	0.2815	9.0200e-003	0.2905		1,069.5285	1,069.5285	0.0620	0.0639	1,090.1253
<b>Total</b>	<b>1.3917</b>	<b>1.1854</b>	<b>6.2564</b>	<b>0.0123</b>	<b>1.0539</b>	<b>0.0398</b>	<b>1.0938</b>	<b>0.2815</b>	<b>0.0393</b>	<b>0.3207</b>	<b>0.0000</b>	<b>1,419.7172</b>	<b>1,419.7172</b>	<b>0.0712</b>	<b>0.0703</b>	<b>1,442.4432</b>

**Mitigated Operational**

	ROG	NOx	CO	SO2	Fugitive PM10	Exhaust PM10	PM10 Total	Fugitive PM2.5	Exhaust PM2.5	PM2.5 Total	Bio- CO2	NBio- CO2	Total CO2	CH4	N2O	CO2e
Category	lb/day										lb/day					
Area	0.9238	0.1813	1.5543	1.1300e-003		0.0215	0.0215		0.0215	0.0215	0.0000	212.3210	212.3210	6.5800e-003	3.8400e-003	213.6310
Energy	0.0126	0.1080	0.0460	6.9000e-004		8.7300e-003	8.7300e-003		8.7300e-003	8.7300e-003		137.8676	137.8676	2.6400e-003	2.5300e-003	138.6869
Mobile	0.4552	0.8961	4.6562	0.0105	1.0539	9.6000e-003	1.0635	0.2815	9.0200e-003	0.2905		1,069.5285	1,069.5285	0.0620	0.0639	1,090.1253
<b>Total</b>	<b>1.3917</b>	<b>1.1854</b>	<b>6.2564</b>	<b>0.0123</b>	<b>1.0539</b>	<b>0.0398</b>	<b>1.0938</b>	<b>0.2815</b>	<b>0.0393</b>	<b>0.3207</b>	<b>0.0000</b>	<b>1,419.7172</b>	<b>1,419.7172</b>	<b>0.0712</b>	<b>0.0703</b>	<b>1,442.4432</b>

Fresno County 18-Unit SFR Project - San Joaquin Valley Unified APCD Air District, Winter

**EMFAC Off-Model Adjustment Factors for Gasoline Light Duty Vehicle to Account for the SAFE Vehicle Rule Not Applied**

	ROG	NOx	CO	SO2	Fugitive PM10	Exhaust PM10	PM10 Total	Fugitive PM2.5	Exhaust PM2.5	PM2.5 Total	Bio- CO2	NBio-CO2	Total CO2	CH4	N2O	CO2e
Percent Reduction	0.00	0.00	0.00	0.00	0.00	0.00	0.00	0.00	0.00	0.00	0.00	0.00	0.00	0.00	0.00	0.00

**3.0 Construction Detail**

**Construction Phase**

Phase Number	Phase Name	Phase Type	Start Date	End Date	Num Days Week	Num Days	Phase Description
1	Demolition	Demolition	7/1/2022	7/28/2022	5	20	
2	Site Preparation	Site Preparation	7/29/2022	8/11/2022	5	10	
3	Grading	Grading	8/12/2022	9/8/2022	5	20	
4	Building Construction	Building Construction	9/9/2022	7/27/2023	5	230	
5	Paving	Paving	7/28/2023	8/24/2023	5	20	
6	Architectural Coating	Architectural Coating	8/25/2023	9/21/2023	5	20	

**Acres of Grading (Site Preparation Phase): 15**

**Acres of Grading (Grading Phase): 20**

**Acres of Paving: 0**

**Residential Indoor: 65,610; Residential Outdoor: 21,870; Non-Residential Indoor: 0; Non-Residential Outdoor: 0; Striped Parking Area: 0 (Architectural Coating – sqft)**

**OffRoad Equipment**

Phase Name	Offroad Equipment Type	Amount	Usage Hours	Horse Power	Load Factor
Architectural Coating	Air Compressors	1	6.00	78	0.48
Demolition	Concrete/Industrial Saws	1	8.00	81	0.73
Building Construction	Cranes	1	7.00	231	0.29
Demolition	Excavators	3	8.00	158	0.38
Grading	Excavators	1	8.00	158	0.38

Fresno County 18-Unit SFR Project - San Joaquin Valley Unified APCD Air District, Winter

**EMFAC Off-Model Adjustment Factors for Gasoline Light Duty Vehicle to Account for the SAFE Vehicle Rule Not Applied**

Building Construction	Forklifts	3	8.00	89	0.20
Building Construction	Generator Sets	1	8.00	84	0.74
Grading	Graders	1	8.00	187	0.41
Paving	Pavers	2	8.00	130	0.42
Paving	Paving Equipment	2	8.00	132	0.36
Paving	Rollers	2	8.00	80	0.38
Demolition	Rubber Tired Dozers	2	8.00	247	0.40
Grading	Rubber Tired Dozers	1	8.00	247	0.40
Site Preparation	Rubber Tired Dozers	3	8.00	247	0.40
Building Construction	Tractors/Loaders/Backhoes	3	7.00	97	0.37
Grading	Tractors/Loaders/Backhoes	3	8.00	97	0.37
Site Preparation	Tractors/Loaders/Backhoes	4	8.00	97	0.37
Building Construction	Welders	1	8.00	46	0.45

**Trips and VMT**

Phase Name	Offroad Equipment Count	Worker Trip Number	Vendor Trip Number	Hauling Trip Number	Worker Trip Length	Vendor Trip Length	Hauling Trip Length	Worker Vehicle Class	Vendor Vehicle Class	Hauling Vehicle Class
Demolition	6	15.00	0.00	0.00	10.80	7.30	20.00	LD_Mix	HDT_Mix	HHDT
Site Preparation	7	18.00	0.00	0.00	10.80	7.30	20.00	LD_Mix	HDT_Mix	HHDT
Grading	6	15.00	0.00	0.00	10.80	7.30	20.00	LD_Mix	HDT_Mix	HHDT
Building Construction	9	6.00	2.00	0.00	10.80	7.30	20.00	LD_Mix	HDT_Mix	HHDT
Paving	6	15.00	0.00	0.00	10.80	7.30	20.00	LD_Mix	HDT_Mix	HHDT
Architectural Coating	1	1.00	0.00	0.00	10.80	7.30	20.00	LD_Mix	HDT_Mix	HHDT

**3.1 Mitigation Measures Construction**

Use Soil Stabilizer

Replace Ground Cover

Water Exposed Area



Fresno County 18-Unit SFR Project - San Joaquin Valley Unified APCD Air District, Winter

**EMFAC Off-Model Adjustment Factors for Gasoline Light Duty Vehicle to Account for the SAFE Vehicle Rule Not Applied**

**3.2 Demolition - 2022**

**Unmitigated Construction On-Site**

	ROG	NOx	CO	SO2	Fugitive PM10	Exhaust PM10	PM10 Total	Fugitive PM2.5	Exhaust PM2.5	PM2.5 Total	Bio- CO2	NBio- CO2	Total CO2	CH4	N2O	CO2e
Category	lb/day										lb/day					
Off-Road	2.6392	25.7194	20.5941	0.0388		1.2427	1.2427		1.1553	1.1553		3,746.7812	3,746.7812	1.0524		3,773.0920
<b>Total</b>	<b>2.6392</b>	<b>25.7194</b>	<b>20.5941</b>	<b>0.0388</b>		<b>1.2427</b>	<b>1.2427</b>		<b>1.1553</b>	<b>1.1553</b>		<b>3,746.7812</b>	<b>3,746.7812</b>	<b>1.0524</b>		<b>3,773.0920</b>

**Unmitigated Construction Off-Site**

	ROG	NOx	CO	SO2	Fugitive PM10	Exhaust PM10	PM10 Total	Fugitive PM2.5	Exhaust PM2.5	PM2.5 Total	Bio- CO2	NBio- CO2	Total CO2	CH4	N2O	CO2e
Category	lb/day										lb/day					
Hauling	0.0000	0.0000	0.0000	0.0000	0.0000	0.0000	0.0000	0.0000	0.0000	0.0000		0.0000	0.0000	0.0000	0.0000	0.0000
Vendor	0.0000	0.0000	0.0000	0.0000	0.0000	0.0000	0.0000	0.0000	0.0000	0.0000		0.0000	0.0000	0.0000	0.0000	0.0000
Worker	0.0528	0.0397	0.4029	1.0500e-003	0.1232	6.7000e-004	0.1239	0.0327	6.2000e-004	0.0333		105.6669	105.6669	3.9800e-003	3.6200e-003	106.8442
<b>Total</b>	<b>0.0528</b>	<b>0.0397</b>	<b>0.4029</b>	<b>1.0500e-003</b>	<b>0.1232</b>	<b>6.7000e-004</b>	<b>0.1239</b>	<b>0.0327</b>	<b>6.2000e-004</b>	<b>0.0333</b>		<b>105.6669</b>	<b>105.6669</b>	<b>3.9800e-003</b>	<b>3.6200e-003</b>	<b>106.8442</b>

Fresno County 18-Unit SFR Project - San Joaquin Valley Unified APCD Air District, Winter

**EMFAC Off-Model Adjustment Factors for Gasoline Light Duty Vehicle to Account for the SAFE Vehicle Rule Not Applied**

**3.2 Demolition - 2022**

**Mitigated Construction On-Site**

	ROG	NOx	CO	SO2	Fugitive PM10	Exhaust PM10	PM10 Total	Fugitive PM2.5	Exhaust PM2.5	PM2.5 Total	Bio- CO2	NBio- CO2	Total CO2	CH4	N2O	CO2e
Category	lb/day										lb/day					
Off-Road	2.6392	25.7194	20.5941	0.0388		1.2427	1.2427		1.1553	1.1553	0.0000	3,746.7812	3,746.7812	1.0524		3,773.0920
<b>Total</b>	<b>2.6392</b>	<b>25.7194</b>	<b>20.5941</b>	<b>0.0388</b>		<b>1.2427</b>	<b>1.2427</b>		<b>1.1553</b>	<b>1.1553</b>	<b>0.0000</b>	<b>3,746.7812</b>	<b>3,746.7812</b>	<b>1.0524</b>		<b>3,773.0920</b>

**Mitigated Construction Off-Site**

	ROG	NOx	CO	SO2	Fugitive PM10	Exhaust PM10	PM10 Total	Fugitive PM2.5	Exhaust PM2.5	PM2.5 Total	Bio- CO2	NBio- CO2	Total CO2	CH4	N2O	CO2e
Category	lb/day										lb/day					
Hauling	0.0000	0.0000	0.0000	0.0000	0.0000	0.0000	0.0000	0.0000	0.0000	0.0000		0.0000	0.0000	0.0000	0.0000	0.0000
Vendor	0.0000	0.0000	0.0000	0.0000	0.0000	0.0000	0.0000	0.0000	0.0000	0.0000		0.0000	0.0000	0.0000	0.0000	0.0000
Worker	0.0528	0.0397	0.4029	1.0500e-003	0.1232	6.7000e-004	0.1239	0.0327	6.2000e-004	0.0333		105.6669	105.6669	3.9800e-003	3.6200e-003	106.8442
<b>Total</b>	<b>0.0528</b>	<b>0.0397</b>	<b>0.4029</b>	<b>1.0500e-003</b>	<b>0.1232</b>	<b>6.7000e-004</b>	<b>0.1239</b>	<b>0.0327</b>	<b>6.2000e-004</b>	<b>0.0333</b>		<b>105.6669</b>	<b>105.6669</b>	<b>3.9800e-003</b>	<b>3.6200e-003</b>	<b>106.8442</b>

Fresno County 18-Unit SFR Project - San Joaquin Valley Unified APCD Air District, Winter

**EMFAC Off-Model Adjustment Factors for Gasoline Light Duty Vehicle to Account for the SAFE Vehicle Rule Not Applied**

**3.3 Site Preparation - 2022**

**Unmitigated Construction On-Site**

	ROG	NOx	CO	SO2	Fugitive PM10	Exhaust PM10	PM10 Total	Fugitive PM2.5	Exhaust PM2.5	PM2.5 Total	Bio- CO2	NBio- CO2	Total CO2	CH4	N2O	CO2e
Category	lb/day										lb/day					
Fugitive Dust					19.6570	0.0000	19.6570	10.1025	0.0000	10.1025			0.0000			0.0000
Off-Road	3.1701	33.0835	19.6978	0.0380		1.6126	1.6126		1.4836	1.4836		3,686.0619	3,686.0619	1.1922		3,715.8655
<b>Total</b>	<b>3.1701</b>	<b>33.0835</b>	<b>19.6978</b>	<b>0.0380</b>	<b>19.6570</b>	<b>1.6126</b>	<b>21.2696</b>	<b>10.1025</b>	<b>1.4836</b>	<b>11.5860</b>		<b>3,686.0619</b>	<b>3,686.0619</b>	<b>1.1922</b>		<b>3,715.8655</b>

**Unmitigated Construction Off-Site**

	ROG	NOx	CO	SO2	Fugitive PM10	Exhaust PM10	PM10 Total	Fugitive PM2.5	Exhaust PM2.5	PM2.5 Total	Bio- CO2	NBio- CO2	Total CO2	CH4	N2O	CO2e
Category	lb/day										lb/day					
Hauling	0.0000	0.0000	0.0000	0.0000	0.0000	0.0000	0.0000	0.0000	0.0000	0.0000		0.0000	0.0000	0.0000	0.0000	0.0000
Vendor	0.0000	0.0000	0.0000	0.0000	0.0000	0.0000	0.0000	0.0000	0.0000	0.0000		0.0000	0.0000	0.0000	0.0000	0.0000
Worker	0.0634	0.0476	0.4835	1.2500e-003	0.1479	8.1000e-004	0.1487	0.0392	7.4000e-004	0.0400		126.8002	126.8002	4.7700e-003	4.3400e-003	128.2130
<b>Total</b>	<b>0.0634</b>	<b>0.0476</b>	<b>0.4835</b>	<b>1.2500e-003</b>	<b>0.1479</b>	<b>8.1000e-004</b>	<b>0.1487</b>	<b>0.0392</b>	<b>7.4000e-004</b>	<b>0.0400</b>		<b>126.8002</b>	<b>126.8002</b>	<b>4.7700e-003</b>	<b>4.3400e-003</b>	<b>128.2130</b>

Fresno County 18-Unit SFR Project - San Joaquin Valley Unified APCD Air District, Winter

**EMFAC Off-Model Adjustment Factors for Gasoline Light Duty Vehicle to Account for the SAFE Vehicle Rule Not Applied**

**3.3 Site Preparation - 2022**

**Mitigated Construction On-Site**

	ROG	NOx	CO	SO2	Fugitive PM10	Exhaust PM10	PM10 Total	Fugitive PM2.5	Exhaust PM2.5	PM2.5 Total	Bio- CO2	NBio- CO2	Total CO2	CH4	N2O	CO2e
Category	lb/day										lb/day					
Fugitive Dust					8.4034	0.0000	8.4034	4.3188	0.0000	4.3188			0.0000			0.0000
Off-Road	3.1701	33.0835	19.6978	0.0380		1.6126	1.6126		1.4836	1.4836	0.0000	3,686.0619	3,686.0619	1.1922		3,715.8655
<b>Total</b>	<b>3.1701</b>	<b>33.0835</b>	<b>19.6978</b>	<b>0.0380</b>	<b>8.4034</b>	<b>1.6126</b>	<b>10.0159</b>	<b>4.3188</b>	<b>1.4836</b>	<b>5.8024</b>	<b>0.0000</b>	<b>3,686.0619</b>	<b>3,686.0619</b>	<b>1.1922</b>		<b>3,715.8655</b>

**Mitigated Construction Off-Site**

	ROG	NOx	CO	SO2	Fugitive PM10	Exhaust PM10	PM10 Total	Fugitive PM2.5	Exhaust PM2.5	PM2.5 Total	Bio- CO2	NBio- CO2	Total CO2	CH4	N2O	CO2e
Category	lb/day										lb/day					
Hauling	0.0000	0.0000	0.0000	0.0000	0.0000	0.0000	0.0000	0.0000	0.0000	0.0000		0.0000	0.0000	0.0000	0.0000	0.0000
Vendor	0.0000	0.0000	0.0000	0.0000	0.0000	0.0000	0.0000	0.0000	0.0000	0.0000		0.0000	0.0000	0.0000	0.0000	0.0000
Worker	0.0634	0.0476	0.4835	1.2500e-003	0.1479	8.1000e-004	0.1487	0.0392	7.4000e-004	0.0400		126.8002	126.8002	4.7700e-003	4.3400e-003	128.2130
<b>Total</b>	<b>0.0634</b>	<b>0.0476</b>	<b>0.4835</b>	<b>1.2500e-003</b>	<b>0.1479</b>	<b>8.1000e-004</b>	<b>0.1487</b>	<b>0.0392</b>	<b>7.4000e-004</b>	<b>0.0400</b>		<b>126.8002</b>	<b>126.8002</b>	<b>4.7700e-003</b>	<b>4.3400e-003</b>	<b>128.2130</b>

Fresno County 18-Unit SFR Project - San Joaquin Valley Unified APCD Air District, Winter

**EMFAC Off-Model Adjustment Factors for Gasoline Light Duty Vehicle to Account for the SAFE Vehicle Rule Not Applied**

**3.4 Grading - 2022**

**Unmitigated Construction On-Site**

	ROG	NOx	CO	SO2	Fugitive PM10	Exhaust PM10	PM10 Total	Fugitive PM2.5	Exhaust PM2.5	PM2.5 Total	Bio- CO2	NBio- CO2	Total CO2	CH4	N2O	CO2e
Category	lb/day										lb/day					
Fugitive Dust					7.0826	0.0000	7.0826	3.4247	0.0000	3.4247			0.0000			0.0000
Off-Road	1.9486	20.8551	15.2727	0.0297		0.9409	0.9409		0.8656	0.8656		2,872.046 4	2,872.046 4	0.9289		2,895.268 4
<b>Total</b>	<b>1.9486</b>	<b>20.8551</b>	<b>15.2727</b>	<b>0.0297</b>	<b>7.0826</b>	<b>0.9409</b>	<b>8.0234</b>	<b>3.4247</b>	<b>0.8656</b>	<b>4.2903</b>		<b>2,872.046 4</b>	<b>2,872.046 4</b>	<b>0.9289</b>		<b>2,895.268 4</b>

**Unmitigated Construction Off-Site**

	ROG	NOx	CO	SO2	Fugitive PM10	Exhaust PM10	PM10 Total	Fugitive PM2.5	Exhaust PM2.5	PM2.5 Total	Bio- CO2	NBio- CO2	Total CO2	CH4	N2O	CO2e
Category	lb/day										lb/day					
Hauling	0.0000	0.0000	0.0000	0.0000	0.0000	0.0000	0.0000	0.0000	0.0000	0.0000		0.0000	0.0000	0.0000	0.0000	0.0000
Vendor	0.0000	0.0000	0.0000	0.0000	0.0000	0.0000	0.0000	0.0000	0.0000	0.0000		0.0000	0.0000	0.0000	0.0000	0.0000
Worker	0.0528	0.0397	0.4029	1.0500e-003	0.1232	6.7000e-004	0.1239	0.0327	6.2000e-004	0.0333		105.6669	105.6669	3.9800e-003	3.6200e-003	106.8442
<b>Total</b>	<b>0.0528</b>	<b>0.0397</b>	<b>0.4029</b>	<b>1.0500e-003</b>	<b>0.1232</b>	<b>6.7000e-004</b>	<b>0.1239</b>	<b>0.0327</b>	<b>6.2000e-004</b>	<b>0.0333</b>		<b>105.6669</b>	<b>105.6669</b>	<b>3.9800e-003</b>	<b>3.6200e-003</b>	<b>106.8442</b>

Fresno County 18-Unit SFR Project - San Joaquin Valley Unified APCD Air District, Winter

**EMFAC Off-Model Adjustment Factors for Gasoline Light Duty Vehicle to Account for the SAFE Vehicle Rule Not Applied**

**3.4 Grading - 2022**

**Mitigated Construction On-Site**

	ROG	NOx	CO	SO2	Fugitive PM10	Exhaust PM10	PM10 Total	Fugitive PM2.5	Exhaust PM2.5	PM2.5 Total	Bio- CO2	NBio- CO2	Total CO2	CH4	N2O	CO2e
Category	lb/day										lb/day					
Fugitive Dust					3.0278	0.0000	3.0278	1.4641	0.0000	1.4641			0.0000			0.0000
Off-Road	1.9486	20.8551	15.2727	0.0297		0.9409	0.9409		0.8656	0.8656	0.0000	2,872.046 4	2,872.046 4	0.9289		2,895.268 4
<b>Total</b>	<b>1.9486</b>	<b>20.8551</b>	<b>15.2727</b>	<b>0.0297</b>	<b>3.0278</b>	<b>0.9409</b>	<b>3.9687</b>	<b>1.4641</b>	<b>0.8656</b>	<b>2.3297</b>	<b>0.0000</b>	<b>2,872.046 4</b>	<b>2,872.046 4</b>	<b>0.9289</b>		<b>2,895.268 4</b>

**Mitigated Construction Off-Site**

	ROG	NOx	CO	SO2	Fugitive PM10	Exhaust PM10	PM10 Total	Fugitive PM2.5	Exhaust PM2.5	PM2.5 Total	Bio- CO2	NBio- CO2	Total CO2	CH4	N2O	CO2e
Category	lb/day										lb/day					
Hauling	0.0000	0.0000	0.0000	0.0000	0.0000	0.0000	0.0000	0.0000	0.0000	0.0000		0.0000	0.0000	0.0000	0.0000	0.0000
Vendor	0.0000	0.0000	0.0000	0.0000	0.0000	0.0000	0.0000	0.0000	0.0000	0.0000		0.0000	0.0000	0.0000	0.0000	0.0000
Worker	0.0528	0.0397	0.4029	1.0500e-003	0.1232	6.7000e-004	0.1239	0.0327	6.2000e-004	0.0333		105.6669	105.6669	3.9800e-003	3.6200e-003	106.8442
<b>Total</b>	<b>0.0528</b>	<b>0.0397</b>	<b>0.4029</b>	<b>1.0500e-003</b>	<b>0.1232</b>	<b>6.7000e-004</b>	<b>0.1239</b>	<b>0.0327</b>	<b>6.2000e-004</b>	<b>0.0333</b>		<b>105.6669</b>	<b>105.6669</b>	<b>3.9800e-003</b>	<b>3.6200e-003</b>	<b>106.8442</b>

Fresno County 18-Unit SFR Project - San Joaquin Valley Unified APCD Air District, Winter

**EMFAC Off-Model Adjustment Factors for Gasoline Light Duty Vehicle to Account for the SAFE Vehicle Rule Not Applied**

**3.5 Building Construction - 2022**

**Unmitigated Construction On-Site**

	ROG	NOx	CO	SO2	Fugitive PM10	Exhaust PM10	PM10 Total	Fugitive PM2.5	Exhaust PM2.5	PM2.5 Total	Bio- CO2	NBio- CO2	Total CO2	CH4	N2O	CO2e
Category	lb/day										lb/day					
Off-Road	1.7062	15.6156	16.3634	0.0269		0.8090	0.8090		0.7612	0.7612		2,554.3336	2,554.3336	0.6120		2,569.6322
<b>Total</b>	<b>1.7062</b>	<b>15.6156</b>	<b>16.3634</b>	<b>0.0269</b>		<b>0.8090</b>	<b>0.8090</b>		<b>0.7612</b>	<b>0.7612</b>		<b>2,554.3336</b>	<b>2,554.3336</b>	<b>0.6120</b>		<b>2,569.6322</b>

**Unmitigated Construction Off-Site**

	ROG	NOx	CO	SO2	Fugitive PM10	Exhaust PM10	PM10 Total	Fugitive PM2.5	Exhaust PM2.5	PM2.5 Total	Bio- CO2	NBio- CO2	Total CO2	CH4	N2O	CO2e
Category	lb/day										lb/day					
Hauling	0.0000	0.0000	0.0000	0.0000	0.0000	0.0000	0.0000	0.0000	0.0000	0.0000		0.0000	0.0000	0.0000	0.0000	0.0000
Vendor	4.2800e-003	0.1122	0.0322	4.2000e-004	0.0136	1.2200e-003	0.0148	3.9000e-003	1.1700e-003	5.0700e-003		44.2928	44.2928	2.8000e-004	6.6400e-003	46.2795
Worker	0.0211	0.0159	0.1612	4.2000e-004	0.0493	2.7000e-004	0.0496	0.0131	2.5000e-004	0.0133		42.2668	42.2668	1.5900e-003	1.4500e-003	42.7377
<b>Total</b>	<b>0.0254</b>	<b>0.1280</b>	<b>0.1934</b>	<b>8.4000e-004</b>	<b>0.0629</b>	<b>1.4900e-003</b>	<b>0.0643</b>	<b>0.0170</b>	<b>1.4200e-003</b>	<b>0.0184</b>		<b>86.5595</b>	<b>86.5595</b>	<b>1.8700e-003</b>	<b>8.0900e-003</b>	<b>89.0171</b>

Fresno County 18-Unit SFR Project - San Joaquin Valley Unified APCD Air District, Winter

**EMFAC Off-Model Adjustment Factors for Gasoline Light Duty Vehicle to Account for the SAFE Vehicle Rule Not Applied**

**3.5 Building Construction - 2022**

**Mitigated Construction On-Site**

	ROG	NOx	CO	SO2	Fugitive PM10	Exhaust PM10	PM10 Total	Fugitive PM2.5	Exhaust PM2.5	PM2.5 Total	Bio- CO2	NBio- CO2	Total CO2	CH4	N2O	CO2e
Category	lb/day										lb/day					
Off-Road	1.7062	15.6156	16.3634	0.0269		0.8090	0.8090		0.7612	0.7612	0.0000	2,554.3336	2,554.3336	0.6120		2,569.6322
<b>Total</b>	<b>1.7062</b>	<b>15.6156</b>	<b>16.3634</b>	<b>0.0269</b>		<b>0.8090</b>	<b>0.8090</b>		<b>0.7612</b>	<b>0.7612</b>	<b>0.0000</b>	<b>2,554.3336</b>	<b>2,554.3336</b>	<b>0.6120</b>		<b>2,569.6322</b>

**Mitigated Construction Off-Site**

	ROG	NOx	CO	SO2	Fugitive PM10	Exhaust PM10	PM10 Total	Fugitive PM2.5	Exhaust PM2.5	PM2.5 Total	Bio- CO2	NBio- CO2	Total CO2	CH4	N2O	CO2e
Category	lb/day										lb/day					
Hauling	0.0000	0.0000	0.0000	0.0000	0.0000	0.0000	0.0000	0.0000	0.0000	0.0000		0.0000	0.0000	0.0000	0.0000	0.0000
Vendor	4.2800e-003	0.1122	0.0322	4.2000e-004	0.0136	1.2200e-003	0.0148	3.9000e-003	1.1700e-003	5.0700e-003		44.2928	44.2928	2.8000e-004	6.6400e-003	46.2795
Worker	0.0211	0.0159	0.1612	4.2000e-004	0.0493	2.7000e-004	0.0496	0.0131	2.5000e-004	0.0133		42.2668	42.2668	1.5900e-003	1.4500e-003	42.7377
<b>Total</b>	<b>0.0254</b>	<b>0.1280</b>	<b>0.1934</b>	<b>8.4000e-004</b>	<b>0.0629</b>	<b>1.4900e-003</b>	<b>0.0643</b>	<b>0.0170</b>	<b>1.4200e-003</b>	<b>0.0184</b>		<b>86.5595</b>	<b>86.5595</b>	<b>1.8700e-003</b>	<b>8.0900e-003</b>	<b>89.0171</b>



Fresno County 18-Unit SFR Project - San Joaquin Valley Unified APCD Air District, Winter

**EMFAC Off-Model Adjustment Factors for Gasoline Light Duty Vehicle to Account for the SAFE Vehicle Rule Not Applied**

**3.5 Building Construction - 2023**

**Unmitigated Construction On-Site**

	ROG	NOx	CO	SO2	Fugitive PM10	Exhaust PM10	PM10 Total	Fugitive PM2.5	Exhaust PM2.5	PM2.5 Total	Bio- CO2	NBio- CO2	Total CO2	CH4	N2O	CO2e
Category	lb/day										lb/day					
Off-Road	1.5728	14.3849	16.2440	0.0269		0.6997	0.6997		0.6584	0.6584		2,555.2099	2,555.2099	0.6079		2,570.4061
<b>Total</b>	<b>1.5728</b>	<b>14.3849</b>	<b>16.2440</b>	<b>0.0269</b>		<b>0.6997</b>	<b>0.6997</b>		<b>0.6584</b>	<b>0.6584</b>		<b>2,555.2099</b>	<b>2,555.2099</b>	<b>0.6079</b>		<b>2,570.4061</b>

**Unmitigated Construction Off-Site**

	ROG	NOx	CO	SO2	Fugitive PM10	Exhaust PM10	PM10 Total	Fugitive PM2.5	Exhaust PM2.5	PM2.5 Total	Bio- CO2	NBio- CO2	Total CO2	CH4	N2O	CO2e
Category	lb/day										lb/day					
Hauling	0.0000	0.0000	0.0000	0.0000	0.0000	0.0000	0.0000	0.0000	0.0000	0.0000		0.0000	0.0000	0.0000	0.0000	0.0000
Vendor	2.1400e-003	0.0906	0.0276	4.0000e-004	0.0136	5.7000e-004	0.0141	3.9000e-003	5.5000e-004	4.4500e-003		42.6674	42.6674	1.8000e-004	6.3900e-003	44.5751
Worker	0.0194	0.0139	0.1473	4.0000e-004	0.0493	2.5000e-004	0.0495	0.0131	2.3000e-004	0.0133		40.9142	40.9142	1.4300e-003	1.3300e-003	41.3452
<b>Total</b>	<b>0.0216</b>	<b>0.1044</b>	<b>0.1749</b>	<b>8.0000e-004</b>	<b>0.0629</b>	<b>8.2000e-004</b>	<b>0.0637</b>	<b>0.0170</b>	<b>7.8000e-004</b>	<b>0.0178</b>		<b>83.5816</b>	<b>83.5816</b>	<b>1.6100e-003</b>	<b>7.7200e-003</b>	<b>85.9202</b>

Fresno County 18-Unit SFR Project - San Joaquin Valley Unified APCD Air District, Winter

**EMFAC Off-Model Adjustment Factors for Gasoline Light Duty Vehicle to Account for the SAFE Vehicle Rule Not Applied**

**3.5 Building Construction - 2023**

**Mitigated Construction On-Site**

	ROG	NOx	CO	SO2	Fugitive PM10	Exhaust PM10	PM10 Total	Fugitive PM2.5	Exhaust PM2.5	PM2.5 Total	Bio- CO2	NBio- CO2	Total CO2	CH4	N2O	CO2e
Category	lb/day										lb/day					
Off-Road	1.5728	14.3849	16.2440	0.0269		0.6997	0.6997		0.6584	0.6584	0.0000	2,555.2099	2,555.2099	0.6079		2,570.4061
<b>Total</b>	<b>1.5728</b>	<b>14.3849</b>	<b>16.2440</b>	<b>0.0269</b>		<b>0.6997</b>	<b>0.6997</b>		<b>0.6584</b>	<b>0.6584</b>	<b>0.0000</b>	<b>2,555.2099</b>	<b>2,555.2099</b>	<b>0.6079</b>		<b>2,570.4061</b>

**Mitigated Construction Off-Site**

	ROG	NOx	CO	SO2	Fugitive PM10	Exhaust PM10	PM10 Total	Fugitive PM2.5	Exhaust PM2.5	PM2.5 Total	Bio- CO2	NBio- CO2	Total CO2	CH4	N2O	CO2e
Category	lb/day										lb/day					
Hauling	0.0000	0.0000	0.0000	0.0000	0.0000	0.0000	0.0000	0.0000	0.0000	0.0000		0.0000	0.0000	0.0000	0.0000	0.0000
Vendor	2.1400e-003	0.0906	0.0276	4.0000e-004	0.0136	5.7000e-004	0.0141	3.9000e-003	5.5000e-004	4.4500e-003		42.6674	42.6674	1.8000e-004	6.3900e-003	44.5751
Worker	0.0194	0.0139	0.1473	4.0000e-004	0.0493	2.5000e-004	0.0495	0.0131	2.3000e-004	0.0133		40.9142	40.9142	1.4300e-003	1.3300e-003	41.3452
<b>Total</b>	<b>0.0216</b>	<b>0.1044</b>	<b>0.1749</b>	<b>8.0000e-004</b>	<b>0.0629</b>	<b>8.2000e-004</b>	<b>0.0637</b>	<b>0.0170</b>	<b>7.8000e-004</b>	<b>0.0178</b>		<b>83.5816</b>	<b>83.5816</b>	<b>1.6100e-003</b>	<b>7.7200e-003</b>	<b>85.9202</b>

Fresno County 18-Unit SFR Project - San Joaquin Valley Unified APCD Air District, Winter

**EMFAC Off-Model Adjustment Factors for Gasoline Light Duty Vehicle to Account for the SAFE Vehicle Rule Not Applied**

**3.6 Paving - 2023**

**Unmitigated Construction On-Site**

	ROG	NOx	CO	SO2	Fugitive PM10	Exhaust PM10	PM10 Total	Fugitive PM2.5	Exhaust PM2.5	PM2.5 Total	Bio- CO2	NBio- CO2	Total CO2	CH4	N2O	CO2e
Category	lb/day										lb/day					
Off-Road	1.0327	10.1917	14.5842	0.0228		0.5102	0.5102		0.4694	0.4694		2,207.5841	2,207.5841	0.7140		2,225.4336
Paving	0.0000					0.0000	0.0000		0.0000	0.0000			0.0000			0.0000
<b>Total</b>	<b>1.0327</b>	<b>10.1917</b>	<b>14.5842</b>	<b>0.0228</b>		<b>0.5102</b>	<b>0.5102</b>		<b>0.4694</b>	<b>0.4694</b>		<b>2,207.5841</b>	<b>2,207.5841</b>	<b>0.7140</b>		<b>2,225.4336</b>

**Unmitigated Construction Off-Site**

	ROG	NOx	CO	SO2	Fugitive PM10	Exhaust PM10	PM10 Total	Fugitive PM2.5	Exhaust PM2.5	PM2.5 Total	Bio- CO2	NBio- CO2	Total CO2	CH4	N2O	CO2e
Category	lb/day										lb/day					
Hauling	0.0000	0.0000	0.0000	0.0000	0.0000	0.0000	0.0000	0.0000	0.0000	0.0000		0.0000	0.0000	0.0000	0.0000	0.0000
Vendor	0.0000	0.0000	0.0000	0.0000	0.0000	0.0000	0.0000	0.0000	0.0000	0.0000		0.0000	0.0000	0.0000	0.0000	0.0000
Worker	0.0485	0.0347	0.3682	1.0100e-003	0.1232	6.3000e-004	0.1239	0.0327	5.8000e-004	0.0333		102.2854	102.2854	3.5700e-003	3.3200e-003	103.3629
<b>Total</b>	<b>0.0485</b>	<b>0.0347</b>	<b>0.3682</b>	<b>1.0100e-003</b>	<b>0.1232</b>	<b>6.3000e-004</b>	<b>0.1239</b>	<b>0.0327</b>	<b>5.8000e-004</b>	<b>0.0333</b>		<b>102.2854</b>	<b>102.2854</b>	<b>3.5700e-003</b>	<b>3.3200e-003</b>	<b>103.3629</b>

Fresno County 18-Unit SFR Project - San Joaquin Valley Unified APCD Air District, Winter

**EMFAC Off-Model Adjustment Factors for Gasoline Light Duty Vehicle to Account for the SAFE Vehicle Rule Not Applied**

**3.6 Paving - 2023**

**Mitigated Construction On-Site**

	ROG	NOx	CO	SO2	Fugitive PM10	Exhaust PM10	PM10 Total	Fugitive PM2.5	Exhaust PM2.5	PM2.5 Total	Bio- CO2	NBio- CO2	Total CO2	CH4	N2O	CO2e
Category	lb/day										lb/day					
Off-Road	1.0327	10.1917	14.5842	0.0228		0.5102	0.5102		0.4694	0.4694	0.0000	2,207.5841	2,207.5841	0.7140		2,225.4336
Paving	0.0000					0.0000	0.0000		0.0000	0.0000			0.0000			0.0000
<b>Total</b>	<b>1.0327</b>	<b>10.1917</b>	<b>14.5842</b>	<b>0.0228</b>		<b>0.5102</b>	<b>0.5102</b>		<b>0.4694</b>	<b>0.4694</b>	<b>0.0000</b>	<b>2,207.5841</b>	<b>2,207.5841</b>	<b>0.7140</b>		<b>2,225.4336</b>

**Mitigated Construction Off-Site**

	ROG	NOx	CO	SO2	Fugitive PM10	Exhaust PM10	PM10 Total	Fugitive PM2.5	Exhaust PM2.5	PM2.5 Total	Bio- CO2	NBio- CO2	Total CO2	CH4	N2O	CO2e
Category	lb/day										lb/day					
Hauling	0.0000	0.0000	0.0000	0.0000	0.0000	0.0000	0.0000	0.0000	0.0000	0.0000		0.0000	0.0000	0.0000	0.0000	0.0000
Vendor	0.0000	0.0000	0.0000	0.0000	0.0000	0.0000	0.0000	0.0000	0.0000	0.0000		0.0000	0.0000	0.0000	0.0000	0.0000
Worker	0.0485	0.0347	0.3682	1.0100e-003	0.1232	6.3000e-004	0.1239	0.0327	5.8000e-004	0.0333		102.2854	102.2854	3.5700e-003	3.3200e-003	103.3629
<b>Total</b>	<b>0.0485</b>	<b>0.0347</b>	<b>0.3682</b>	<b>1.0100e-003</b>	<b>0.1232</b>	<b>6.3000e-004</b>	<b>0.1239</b>	<b>0.0327</b>	<b>5.8000e-004</b>	<b>0.0333</b>		<b>102.2854</b>	<b>102.2854</b>	<b>3.5700e-003</b>	<b>3.3200e-003</b>	<b>103.3629</b>

Fresno County 18-Unit SFR Project - San Joaquin Valley Unified APCD Air District, Winter

**EMFAC Off-Model Adjustment Factors for Gasoline Light Duty Vehicle to Account for the SAFE Vehicle Rule Not Applied**

**3.7 Architectural Coating - 2023**

**Unmitigated Construction On-Site**

	ROG	NOx	CO	SO2	Fugitive PM10	Exhaust PM10	PM10 Total	Fugitive PM2.5	Exhaust PM2.5	PM2.5 Total	Bio- CO2	NBio- CO2	Total CO2	CH4	N2O	CO2e
Category	lb/day										lb/day					
Archit. Coating	30.4102					0.0000	0.0000		0.0000	0.0000			0.0000			0.0000
Off-Road	0.1917	1.3030	1.8111	2.9700e-003		0.0708	0.0708		0.0708	0.0708		281.4481	281.4481	0.0168		281.8690
<b>Total</b>	<b>30.6019</b>	<b>1.3030</b>	<b>1.8111</b>	<b>2.9700e-003</b>		<b>0.0708</b>	<b>0.0708</b>		<b>0.0708</b>	<b>0.0708</b>		<b>281.4481</b>	<b>281.4481</b>	<b>0.0168</b>		<b>281.8690</b>

**Unmitigated Construction Off-Site**

	ROG	NOx	CO	SO2	Fugitive PM10	Exhaust PM10	PM10 Total	Fugitive PM2.5	Exhaust PM2.5	PM2.5 Total	Bio- CO2	NBio- CO2	Total CO2	CH4	N2O	CO2e
Category	lb/day										lb/day					
Hauling	0.0000	0.0000	0.0000	0.0000	0.0000	0.0000	0.0000	0.0000	0.0000	0.0000		0.0000	0.0000	0.0000	0.0000	0.0000
Vendor	0.0000	0.0000	0.0000	0.0000	0.0000	0.0000	0.0000	0.0000	0.0000	0.0000		0.0000	0.0000	0.0000	0.0000	0.0000
Worker	3.2400e-003	2.3100e-003	0.0245	7.0000e-005	8.2100e-003	4.0000e-005	8.2600e-003	2.1800e-003	4.0000e-005	2.2200e-003		6.8190	6.8190	2.4000e-004	2.2000e-004	6.8909
<b>Total</b>	<b>3.2400e-003</b>	<b>2.3100e-003</b>	<b>0.0245</b>	<b>7.0000e-005</b>	<b>8.2100e-003</b>	<b>4.0000e-005</b>	<b>8.2600e-003</b>	<b>2.1800e-003</b>	<b>4.0000e-005</b>	<b>2.2200e-003</b>		<b>6.8190</b>	<b>6.8190</b>	<b>2.4000e-004</b>	<b>2.2000e-004</b>	<b>6.8909</b>

Fresno County 18-Unit SFR Project - San Joaquin Valley Unified APCD Air District, Winter

**EMFAC Off-Model Adjustment Factors for Gasoline Light Duty Vehicle to Account for the SAFE Vehicle Rule Not Applied**

**3.7 Architectural Coating - 2023**

**Mitigated Construction On-Site**

	ROG	NOx	CO	SO2	Fugitive PM10	Exhaust PM10	PM10 Total	Fugitive PM2.5	Exhaust PM2.5	PM2.5 Total	Bio- CO2	NBio- CO2	Total CO2	CH4	N2O	CO2e
Category	lb/day										lb/day					
Archit. Coating	30.4102					0.0000	0.0000		0.0000	0.0000			0.0000			0.0000
Off-Road	0.1917	1.3030	1.8111	2.9700e-003		0.0708	0.0708		0.0708	0.0708	0.0000	281.4481	281.4481	0.0168		281.8690
<b>Total</b>	<b>30.6019</b>	<b>1.3030</b>	<b>1.8111</b>	<b>2.9700e-003</b>		<b>0.0708</b>	<b>0.0708</b>		<b>0.0708</b>	<b>0.0708</b>	<b>0.0000</b>	<b>281.4481</b>	<b>281.4481</b>	<b>0.0168</b>		<b>281.8690</b>

**Mitigated Construction Off-Site**

	ROG	NOx	CO	SO2	Fugitive PM10	Exhaust PM10	PM10 Total	Fugitive PM2.5	Exhaust PM2.5	PM2.5 Total	Bio- CO2	NBio- CO2	Total CO2	CH4	N2O	CO2e
Category	lb/day										lb/day					
Hauling	0.0000	0.0000	0.0000	0.0000	0.0000	0.0000	0.0000	0.0000	0.0000	0.0000		0.0000	0.0000	0.0000	0.0000	0.0000
Vendor	0.0000	0.0000	0.0000	0.0000	0.0000	0.0000	0.0000	0.0000	0.0000	0.0000		0.0000	0.0000	0.0000	0.0000	0.0000
Worker	3.2400e-003	2.3100e-003	0.0245	7.0000e-005	8.2100e-003	4.0000e-005	8.2600e-003	2.1800e-003	4.0000e-005	2.2200e-003		6.8190	6.8190	2.4000e-004	2.2000e-004	6.8909
<b>Total</b>	<b>3.2400e-003</b>	<b>2.3100e-003</b>	<b>0.0245</b>	<b>7.0000e-005</b>	<b>8.2100e-003</b>	<b>4.0000e-005</b>	<b>8.2600e-003</b>	<b>2.1800e-003</b>	<b>4.0000e-005</b>	<b>2.2200e-003</b>		<b>6.8190</b>	<b>6.8190</b>	<b>2.4000e-004</b>	<b>2.2000e-004</b>	<b>6.8909</b>

Fresno County 18-Unit SFR Project - San Joaquin Valley Unified APCD Air District, Winter

**EMFAC Off-Model Adjustment Factors for Gasoline Light Duty Vehicle to Account for the SAFE Vehicle Rule Not Applied**

**4.0 Operational Detail - Mobile**

**4.1 Mitigation Measures Mobile**

	ROG	NOx	CO	SO2	Fugitive PM10	Exhaust PM10	PM10 Total	Fugitive PM2.5	Exhaust PM2.5	PM2.5 Total	Bio- CO2	NBio- CO2	Total CO2	CH4	N2O	CO2e
Category	lb/day										lb/day					
Mitigated	0.4552	0.8961	4.6562	0.0105	1.0539	9.6000e-003	1.0635	0.2815	9.0200e-003	0.2905		1,069.5285	1,069.5285	0.0620	0.0639	1,090.1253
Unmitigated	0.4552	0.8961	4.6562	0.0105	1.0539	9.6000e-003	1.0635	0.2815	9.0200e-003	0.2905		1,069.5285	1,069.5285	0.0620	0.0639	1,090.1253

**4.2 Trip Summary Information**

Land Use	Average Daily Trip Rate			Unmitigated	Mitigated
	Weekday	Saturday	Sunday	Annual VMT	Annual VMT
Single Family Housing	169.92	171.72	153.90	486,510	486,510
Total	169.92	171.72	153.90	486,510	486,510

**4.3 Trip Type Information**

Land Use	Miles			Trip %			Trip Purpose %		
	H-W or C-W	H-S or C-C	H-O or C-NW	H-W or C-W	H-S or C-C	H-O or C-NW	Primary	Diverted	Pass-by
Single Family Housing	10.80	7.30	7.50	45.60	19.00	35.40	86	11	3

**4.4 Fleet Mix**

Land Use	LDA	LDT1	LDT2	MDV	LHD1	LHD2	MHD	HHD	OBUS	UBUS	MCY	SBUS	MH
Single Family Housing	0.511221	0.052103	0.170611	0.160645	0.028932	0.007649	0.013284	0.025916	0.000654	0.000315	0.023645	0.001472	0.003552

Fresno County 18-Unit SFR Project - San Joaquin Valley Unified APCD Air District, Winter

**EMFAC Off-Model Adjustment Factors for Gasoline Light Duty Vehicle to Account for the SAFE Vehicle Rule Not Applied**

**5.0 Energy Detail**

Historical Energy Use: N

**5.1 Mitigation Measures Energy**

	ROG	NOx	CO	SO2	Fugitive PM10	Exhaust PM10	PM10 Total	Fugitive PM2.5	Exhaust PM2.5	PM2.5 Total	Bio- CO2	NBio- CO2	Total CO2	CH4	N2O	CO2e
Category	lb/day										lb/day					
NaturalGas Mitigated	0.0126	0.1080	0.0460	6.9000e-004		8.7300e-003	8.7300e-003		8.7300e-003	8.7300e-003		137.8676	137.8676	2.6400e-003	2.5300e-003	138.6869
NaturalGas Unmitigated	0.0126	0.1080	0.0460	6.9000e-004		8.7300e-003	8.7300e-003		8.7300e-003	8.7300e-003		137.8676	137.8676	2.6400e-003	2.5300e-003	138.6869

**5.2 Energy by Land Use - NaturalGas**

**Unmitigated**

	NaturalGas Use	ROG	NOx	CO	SO2	Fugitive PM10	Exhaust PM10	PM10 Total	Fugitive PM2.5	Exhaust PM2.5	PM2.5 Total	Bio- CO2	NBio- CO2	Total CO2	CH4	N2O	CO2e
Land Use	kBTU/yr	lb/day										lb/day					
Single Family Housing	1171.87	0.0126	0.1080	0.0460	6.9000e-004		8.7300e-003	8.7300e-003		8.7300e-003	8.7300e-003		137.8676	137.8676	2.6400e-003	2.5300e-003	138.6869
<b>Total</b>		<b>0.0126</b>	<b>0.1080</b>	<b>0.0460</b>	<b>6.9000e-004</b>		<b>8.7300e-003</b>	<b>8.7300e-003</b>		<b>8.7300e-003</b>	<b>8.7300e-003</b>		<b>137.8676</b>	<b>137.8676</b>	<b>2.6400e-003</b>	<b>2.5300e-003</b>	<b>138.6869</b>



Fresno County 18-Unit SFR Project - San Joaquin Valley Unified APCD Air District, Winter

**EMFAC Off-Model Adjustment Factors for Gasoline Light Duty Vehicle to Account for the SAFE Vehicle Rule Not Applied**

**5.2 Energy by Land Use - Natural Gas**

Mitigated

	Natural Gas Use	ROG	NOx	CO	SO2	Fugitive PM10	Exhaust PM10	PM10 Total	Fugitive PM2.5	Exhaust PM2.5	PM2.5 Total	Bio- CO2	NBio- CO2	Total CO2	CH4	N2O	CO2e
Land Use	kBTU/yr	lb/day											lb/day				
Single Family Housing	1.17187	0.0126	0.1080	0.0460	6.9000e-004		8.7300e-003	8.7300e-003		8.7300e-003	8.7300e-003		137.8676	137.8676	2.6400e-003	2.5300e-003	138.6869
<b>Total</b>		<b>0.0126</b>	<b>0.1080</b>	<b>0.0460</b>	<b>6.9000e-004</b>		<b>8.7300e-003</b>	<b>8.7300e-003</b>		<b>8.7300e-003</b>	<b>8.7300e-003</b>		<b>137.8676</b>	<b>137.8676</b>	<b>2.6400e-003</b>	<b>2.5300e-003</b>	<b>138.6869</b>

**6.0 Area Detail**

**6.1 Mitigation Measures Area**

	ROG	NOx	CO	SO2	Fugitive PM10	Exhaust PM10	PM10 Total	Fugitive PM2.5	Exhaust PM2.5	PM2.5 Total	Bio- CO2	NBio- CO2	Total CO2	CH4	N2O	CO2e
Category	lb/day											lb/day				
Mitigated	0.9238	0.1813	1.5543	1.1300e-003		0.0215	0.0215		0.0215	0.0215	0.0000	212.3210	212.3210	6.5800e-003	3.8400e-003	213.6310
Unmitigated	0.9238	0.1813	1.5543	1.1300e-003		0.0215	0.0215		0.0215	0.0215	0.0000	212.3210	212.3210	6.5800e-003	3.8400e-003	213.6310

Fresno County 18-Unit SFR Project - San Joaquin Valley Unified APCD Air District, Winter

**EMFAC Off-Model Adjustment Factors for Gasoline Light Duty Vehicle to Account for the SAFE Vehicle Rule Not Applied**

**6.2 Area by SubCategory**

**Unmitigated**

	ROG	NOx	CO	SO2	Fugitive PM10	Exhaust PM10	PM10 Total	Fugitive PM2.5	Exhaust PM2.5	PM2.5 Total	Bio- CO2	NBio- CO2	Total CO2	CH4	N2O	CO2e
SubCategory	lb/day										lb/day					
Architectural Coating	0.1666					0.0000	0.0000		0.0000	0.0000			0.0000			0.0000
Consumer Products	0.6934					0.0000	0.0000		0.0000	0.0000			0.0000			0.0000
Hearth	0.0192	0.1642	0.0699	1.0500e-003		0.0133	0.0133		0.0133	0.0133	0.0000	209.6471	209.6471	4.0200e-003	3.8400e-003	210.8929
Landscaping	0.0446	0.0171	1.4844	8.0000e-005		8.2300e-003	8.2300e-003		8.2300e-003	8.2300e-003		2.6739	2.6739	2.5700e-003		2.7381
<b>Total</b>	<b>0.9238</b>	<b>0.1813</b>	<b>1.5543</b>	<b>1.1300e-003</b>		<b>0.0215</b>	<b>0.0215</b>		<b>0.0215</b>	<b>0.0215</b>	<b>0.0000</b>	<b>212.3210</b>	<b>212.3210</b>	<b>6.5900e-003</b>	<b>3.8400e-003</b>	<b>213.6310</b>

Fresno County 18-Unit SFR Project - San Joaquin Valley Unified APCD Air District, Winter

**EMFAC Off-Model Adjustment Factors for Gasoline Light Duty Vehicle to Account for the SAFE Vehicle Rule Not Applied**

**6.2 Area by SubCategory**

Mitigated

	ROG	NOx	CO	SO2	Fugitive PM10	Exhaust PM10	PM10 Total	Fugitive PM2.5	Exhaust PM2.5	PM2.5 Total	Bio- CO2	NBio- CO2	Total CO2	CH4	N2O	CO2e
SubCategory	lb/day										lb/day					
Architectural Coating	0.1666					0.0000	0.0000		0.0000	0.0000			0.0000			0.0000
Consumer Products	0.6934					0.0000	0.0000		0.0000	0.0000			0.0000			0.0000
Hearth	0.0192	0.1642	0.0699	1.0500e-003		0.0133	0.0133		0.0133	0.0133	0.0000	209.6471	209.6471	4.0200e-003	3.8400e-003	210.8929
Landscaping	0.0446	0.0171	1.4844	8.0000e-005		8.2300e-003	8.2300e-003		8.2300e-003	8.2300e-003		2.6739	2.6739	2.5700e-003		2.7381
<b>Total</b>	<b>0.9238</b>	<b>0.1813</b>	<b>1.5543</b>	<b>1.1300e-003</b>		<b>0.0215</b>	<b>0.0215</b>		<b>0.0215</b>	<b>0.0215</b>	<b>0.0000</b>	<b>212.3210</b>	<b>212.3210</b>	<b>6.5900e-003</b>	<b>3.8400e-003</b>	<b>213.6310</b>

**7.0 Water Detail**

**7.1 Mitigation Measures Water**

Fresno County 18-Unit SFR Project - San Joaquin Valley Unified APCD Air District, Winter

**EMFAC Off-Model Adjustment Factors for Gasoline Light Duty Vehicle to Account for the SAFE Vehicle Rule Not Applied**

**8.0 Waste Detail**

---

**8.1 Mitigation Measures Waste**

**9.0 Operational Offroad**

---

Equipment Type	Number	Hours/Day	Days/Year	Horse Power	Load Factor	Fuel Type
----------------	--------	-----------	-----------	-------------	-------------	-----------

**10.0 Stationary Equipment**

---

**Fire Pumps and Emergency Generators**

Equipment Type	Number	Hours/Day	Hours/Year	Horse Power	Load Factor	Fuel Type
----------------	--------	-----------	------------	-------------	-------------	-----------

**Boilers**

Equipment Type	Number	Heat Input/Day	Heat Input/Year	Boiler Rating	Fuel Type
----------------	--------	----------------	-----------------	---------------	-----------

**User Defined Equipment**

Equipment Type	Number
----------------	--------

**11.0 Vegetation**

---

### Fresno County 18-Unit SFR Project

#### EMFAC Off-Model Adjustment Factors for Gasoline Light Duty Vehicle to Account for the SAFE Vehicle Rule Not Applied

#### San Joaquin Valley Unified APCD Air District, Mitigation Report

#### Construction Mitigation Summary

Phase	ROG	NOx	CO	SO2	Exhaust PM10	Exhaust PM2.5	Bio- CO2	NBio-CO2	Total CO2	CH4	N2O	CO2e
Percent Reduction												
Architectural Coating	0.00	0.00	0.00	0.00	0.00	0.00	0.00	0.00	0.00	0.00	0.00	0.00
Building Construction	0.00	0.00	0.00	0.00	0.00	0.00	0.00	0.00	0.00	0.00	0.00	0.00
Demolition	0.00	0.00	0.00	0.00	0.00	0.00	0.00	0.00	0.00	0.00	0.00	0.00
Grading	0.00	0.00	0.00	0.00	0.00	0.00	0.00	0.00	0.00	0.00	0.00	0.00
Paving	0.00	0.00	0.00	0.00	0.00	0.00	0.00	0.00	0.00	0.00	0.00	0.00
Site Preparation	0.00	0.00	0.00	0.00	0.00	0.00	0.00	0.00	0.00	0.00	0.00	0.00

#### OFFROAD Equipment Mitigation

**Fresno County 18-Unit SFR Project**

**EMFAC Off-Model Adjustment Factors for Gasoline Light Duty Vehicle to Account for the SAFE Vehicle Rule Not Applied**

Equipment Type	Fuel Type	Tier	Number Mitigated	Total Number of Equipment	DPF	Oxidation Catalyst
Air Compressors	Diesel	No Change	0	1	No Change	0.00
Excavators	Diesel	No Change	0	4	No Change	0.00
Concrete/Industrial Saws	Diesel	No Change	0	1	No Change	0.00
Cranes	Diesel	No Change	0	1	No Change	0.00
Forklifts	Diesel	No Change	0	3	No Change	0.00
Graders	Diesel	No Change	0	1	No Change	0.00
Pavers	Diesel	No Change	0	2	No Change	0.00
Rollers	Diesel	No Change	0	2	No Change	0.00
Rubber Tired Dozers	Diesel	No Change	0	6	No Change	0.00
Tractors/Loaders/Backhoes	Diesel	No Change	0	10	No Change	0.00
Generator Sets	Diesel	No Change	0	1	No Change	0.00
Paving Equipment	Diesel	No Change	0	2	No Change	0.00
Welders	Diesel	No Change	0	1	No Change	0.00

### Fresno County 18-Unit SFR Project

#### EMFAC Off-Model Adjustment Factors for Gasoline Light Duty Vehicle to Account for the SAFE Vehicle Rule Not Applied

Equipment Type	ROG	NOx	CO	SO2	Exhaust PM10	Exhaust PM2.5	Bio- CO2	NBio- CO2	Total CO2	CH4	N2O	CO2e
Unmitigated tons/yr							Unmitigated mt/yr					
Air Compressors	1.92000E-003	1.30300E-002	1.81100E-002	3.00000E-005	7.10000E-004	7.10000E-004	0.00000E+000	2.55325E+000	2.55325E+000	1.50000E-004	0.00000E+000	2.55707E+000
Concrete/Industrial Saws	3.58000E-003	2.80100E-002	3.66500E-002	6.00000E-005	1.50000E-003	1.50000E-003	0.00000E+000	5.37656E+000	5.37656E+000	2.90000E-004	0.00000E+000	5.38390E+000
Cranes	3.61300E-002	3.97000E-001	1.86640E-001	5.80000E-004	1.65400E-002	1.52200E-002	0.00000E+000	5.10124E+001	5.10124E+001	1.65000E-002	0.00000E+000	5.14249E+001
Excavators	8.10000E-003	7.10800E-002	1.30210E-001	2.10000E-004	3.44000E-003	3.16000E-003	0.00000E+000	1.81443E+001	1.81443E+001	5.87000E-003	0.00000E+000	1.82910E+001
Forklifts	3.67200E-002	3.42660E-001	3.96040E-001	5.30000E-004	2.17400E-002	2.00000E-002	0.00000E+000	4.63305E+001	4.63305E+001	1.49800E-002	0.00000E+000	4.67051E+001
Generator Sets	3.61500E-002	3.20900E-001	4.22240E-001	7.60000E-004	1.55100E-002	1.55100E-002	0.00000E+000	6.49989E+001	6.49989E+001	2.94000E-003	0.00000E+000	6.50724E+001
Graders	4.15000E-003	5.25800E-002	1.72200E-002	7.00000E-005	1.67000E-003	1.54000E-003	0.00000E+000	5.81758E+000	5.81758E+000	1.88000E-003	0.00000E+000	5.86462E+000
Pavers	3.84000E-003	3.76600E-002	5.76600E-002	9.00000E-005	1.77000E-003	1.63000E-003	0.00000E+000	8.25932E+000	8.25932E+000	2.67000E-003	0.00000E+000	8.32611E+000
Paving Equipment	3.41000E-003	3.20600E-002	5.11300E-002	8.00000E-005	1.56000E-003	1.43000E-003	0.00000E+000	7.15709E+000	7.15709E+000	2.31000E-003	0.00000E+000	7.21496E+000
Rollers	3.07000E-003	3.22000E-002	3.70400E-002	5.00000E-005	1.77000E-003	1.63000E-003	0.00000E+000	4.61045E+000	4.61045E+000	1.49000E-003	0.00000E+000	4.64773E+000
Rubber Tired Dozers	3.76700E-002	3.95710E-001	1.61190E-001	3.80000E-004	1.87800E-002	1.72800E-002	0.00000E+000	3.37623E+001	3.37623E+001	1.09200E-002	0.00000E+000	3.40353E+001
Tractors/Loaders/Backhoes	5.53500E-002	5.62240E-001	7.86180E-001	1.10000E-003	2.89100E-002	2.66000E-002	0.00000E+000	9.62201E+001	9.62201E+001	3.11200E-002	0.00000E+000	9.69981E+001
Welders	3.01700E-002	1.65080E-001	1.93690E-001	2.90000E-004	6.69000E-003	6.69000E-003	0.00000E+000	2.16454E+001	2.16454E+001	2.44000E-003	0.00000E+000	2.17064E+001

### Fresno County 18-Unit SFR Project

#### EMFAC Off-Model Adjustment Factors for Gasoline Light Duty Vehicle to Account for the SAFE Vehicle Rule Not Applied

Equipment Type	ROG	NOx	CO	SO2	Exhaust PM10	Exhaust PM2.5	Bio- CO2	NBio- CO2	Total CO2	CH4	N2O	CO2e
Mitigated tons/yr							Mitigated mt/yr					
Air Compressors	1.92000E-003	1.30300E-002	1.81100E-002	3.00000E-005	7.10000E-004	7.10000E-004	0.00000E+000	2.55325E+000	2.55325E+000	1.50000E-004	0.00000E+000	2.55707E+000
Concrete/Industrial Saws	3.58000E-003	2.80100E-002	3.66500E-002	6.00000E-005	1.50000E-003	1.50000E-003	0.00000E+000	5.37656E+000	5.37656E+000	2.90000E-004	0.00000E+000	5.38389E+000
Cranes	3.61300E-002	3.97000E-001	1.86640E-001	5.80000E-004	1.65400E-002	1.52200E-002	0.00000E+000	5.10124E+001	5.10124E+001	1.65000E-002	0.00000E+000	5.14248E+001
Excavators	8.10000E-003	7.10800E-002	1.30210E-001	2.10000E-004	3.44000E-003	3.16000E-003	0.00000E+000	1.81442E+001	1.81442E+001	5.87000E-003	0.00000E+000	1.82909E+001
Forklifts	3.67200E-002	3.42660E-001	3.96040E-001	5.30000E-004	2.17400E-002	2.00000E-002	0.00000E+000	4.63305E+001	4.63305E+001	1.49800E-002	0.00000E+000	4.67051E+001
Generator Sets	3.61500E-002	3.20900E-001	4.22240E-001	7.60000E-004	1.55100E-002	1.55100E-002	0.00000E+000	6.49988E+001	6.49988E+001	2.94000E-003	0.00000E+000	6.50723E+001
Graders	4.15000E-003	5.25800E-002	1.72200E-002	7.00000E-005	1.67000E-003	1.54000E-003	0.00000E+000	5.81758E+000	5.81758E+000	1.88000E-003	0.00000E+000	5.86462E+000
Pavers	3.84000E-003	3.76600E-002	5.76600E-002	9.00000E-005	1.77000E-003	1.63000E-003	0.00000E+000	8.25931E+000	8.25931E+000	2.67000E-003	0.00000E+000	8.32610E+000
Paving Equipment	3.41000E-003	3.20600E-002	5.11300E-002	8.00000E-005	1.56000E-003	1.43000E-003	0.00000E+000	7.15708E+000	7.15708E+000	2.31000E-003	0.00000E+000	7.21495E+000
Rollers	3.07000E-003	3.22000E-002	3.70400E-002	5.00000E-005	1.77000E-003	1.63000E-003	0.00000E+000	4.61045E+000	4.61045E+000	1.49000E-003	0.00000E+000	4.64772E+000
Rubber Tired Dozers	3.76700E-002	3.95710E-001	1.61190E-001	3.80000E-004	1.87800E-002	1.72800E-002	0.00000E+000	3.37623E+001	3.37623E+001	1.09200E-002	0.00000E+000	3.40353E+001
Tractors/Loaders/Backhoes	5.53500E-002	5.62240E-001	7.86180E-001	1.10000E-003	2.89100E-002	2.66000E-002	0.00000E+000	9.62200E+001	9.62200E+001	3.11200E-002	0.00000E+000	9.69979E+001
Welders	3.01700E-002	1.65080E-001	1.93690E-001	2.90000E-004	6.69000E-003	6.69000E-003	0.00000E+000	2.16454E+001	2.16454E+001	2.44000E-003	0.00000E+000	2.17064E+001



### Fresno County 18-Unit SFR Project

#### EMFAC Off-Model Adjustment Factors for Gasoline Light Duty Vehicle to Account for the SAFE Vehicle Rule Not Applied

Equipment Type	ROG	NOx	CO	SO2	Exhaust PM10	Exhaust PM2.5	Bio- CO2	NBio- CO2	Total CO2	CH4	N2O	CO2e
Percent Reduction												
Air Compressors	0.00000E+000	0.00000E+000	0.00000E+000	0.00000E+000	0.00000E+000	0.00000E+000	0.00000E+000	0.00000E+000	0.00000E+000	0.00000E+000	0.00000E+000	0.00000E+000
Concrete/Industrial Saws	0.00000E+000	0.00000E+000	0.00000E+000	0.00000E+000	0.00000E+000	0.00000E+000	0.00000E+000	0.00000E+000	0.00000E+000	0.00000E+000	0.00000E+000	1.85739E-006
Cranes	0.00000E+000	0.00000E+000	0.00000E+000	0.00000E+000	0.00000E+000	0.00000E+000	0.00000E+000	1.17618E-006	1.17618E-006	0.00000E+000	0.00000E+000	1.16675E-006
Excavators	0.00000E+000	0.00000E+000	0.00000E+000	0.00000E+000	0.00000E+000	0.00000E+000	0.00000E+000	1.10228E-006	1.10228E-006	0.00000E+000	0.00000E+000	1.09344E-006
Forklifts	0.00000E+000	0.00000E+000	0.00000E+000	0.00000E+000	0.00000E+000	0.00000E+000	0.00000E+000	1.07920E-006	1.07920E-006	0.00000E+000	0.00000E+000	1.28466E-006
Generator Sets	0.00000E+000	0.00000E+000	0.00000E+000	0.00000E+000	0.00000E+000	0.00000E+000	0.00000E+000	1.23079E-006	1.23079E-006	0.00000E+000	0.00000E+000	1.22940E-006
Graders	0.00000E+000	0.00000E+000	0.00000E+000	0.00000E+000	0.00000E+000	0.00000E+000	0.00000E+000	0.00000E+000	0.00000E+000	0.00000E+000	0.00000E+000	0.00000E+000
Pavers	0.00000E+000	0.00000E+000	0.00000E+000	0.00000E+000	0.00000E+000	0.00000E+000	0.00000E+000	1.21075E-006	1.21075E-006	0.00000E+000	0.00000E+000	1.20104E-006
Paving Equipment	0.00000E+000	0.00000E+000	0.00000E+000	0.00000E+000	0.00000E+000	0.00000E+000	0.00000E+000	1.39722E-006	1.39722E-006	0.00000E+000	0.00000E+000	1.38601E-006
Rollers	0.00000E+000	0.00000E+000	0.00000E+000	0.00000E+000	0.00000E+000	0.00000E+000	0.00000E+000	0.00000E+000	0.00000E+000	0.00000E+000	0.00000E+000	2.15159E-006
Rubber Tired Dozers	0.00000E+000	0.00000E+000	0.00000E+000	0.00000E+000	0.00000E+000	0.00000E+000	0.00000E+000	1.18475E-006	1.18475E-006	0.00000E+000	0.00000E+000	1.17525E-006
Tractors/Loaders/Backhoes	0.00000E+000	0.00000E+000	0.00000E+000	0.00000E+000	0.00000E+000	0.00000E+000	0.00000E+000	1.24714E-006	1.24714E-006	0.00000E+000	0.00000E+000	1.13404E-006
Welders	0.00000E+000	0.00000E+000	0.00000E+000	0.00000E+000	0.00000E+000	0.00000E+000	0.00000E+000	9.23985E-007	9.23985E-007	0.00000E+000	0.00000E+000	1.38208E-006

#### Fugitive Dust Mitigation

Yes/No Mitigation Measure Mitigation Input Mitigation Input Mitigation Input

Yes	Soil Stabilizer for unpaved Roads	PM10 Reduction	10.00	PM2.5 Reduction	10.00	
-----	-----------------------------------	----------------	-------	-----------------	-------	--

### Fresno County 18-Unit SFR Project

#### EMFAC Off-Model Adjustment Factors for Gasoline Light Duty Vehicle to Account for the SAFE Vehicle Rule Not Applied

Yes	Replace Ground Cover of Area Disturbed	PM10 Reduction	5.00	PM2.5 Reduction	5.00		
Yes	Water Exposed Area	PM10 Reduction	55.00	PM2.5 Reduction	55.00	Frequency (per day)	2.00
No	Unpaved Road Mitigation	Moisture Content %	0.00	Vehicle Speed (mph)	0.00		
No	Clean Paved Road	% PM Reduction	0.00				

Phase	Source	Unmitigated		Mitigated		Percent Reduction	
		PM10	PM2.5	PM10	PM2.5	PM10	PM2.5
Architectural Coating	Fugitive Dust	0.00	0.00	0.00	0.00	0.00	0.00
Architectural Coating	Roads	0.00	0.00	0.00	0.00	0.00	0.00
Building Construction	Fugitive Dust	0.00	0.00	0.00	0.00	0.00	0.00
Building Construction	Roads	0.01	0.00	0.01	0.00	0.00	0.00
Demolition	Fugitive Dust	0.00	0.00	0.00	0.00	0.00	0.00
Demolition	Roads	0.00	0.00	0.00	0.00	0.00	0.00
Grading	Fugitive Dust	0.07	0.03	0.03	0.01	0.57	0.57
Grading	Roads	0.00	0.00	0.00	0.00	0.00	0.00
Paving	Fugitive Dust	0.00	0.00	0.00	0.00	0.00	0.00
Paving	Roads	0.00	0.00	0.00	0.00	0.00	0.00
Site Preparation	Fugitive Dust	0.10	0.05	0.04	0.02	0.57	0.57
Site Preparation	Roads	0.00	0.00	0.00	0.00	0.00	0.00

#### Operational Percent Reduction Summary

### Fresno County 18-Unit SFR Project

#### EMFAC Off-Model Adjustment Factors for Gasoline Light Duty Vehicle to Account for the SAFE Vehicle Rule Not Applied

Category	ROG	NOx	CO	SO2	Exhaust PM10	Exhaust PM2.5	Bio- CO2	NBio- CO2	Total CO2	CH4	N2O	CO2e
Percent Reduction												
Architectural Coating	0.00	0.00	0.00	0.00	0.00	0.00	0.00	0.00	0.00	0.00	0.00	0.00
Consumer Products	0.00	0.00	0.00	0.00	0.00	0.00	0.00	0.00	0.00	0.00	0.00	0.00
Hearth	0.00	0.00	0.00	0.00	0.00	0.00	0.00	0.00	0.00	0.00	0.00	0.00
Landscaping	0.00	0.00	0.00	0.00	0.00	0.00	0.00	0.00	0.00	0.00	0.00	0.00
Mobile	0.00	0.00	0.00	0.00	0.00	0.00	0.00	0.00	0.00	0.00	0.00	0.00
Natural Gas	0.00	0.00	0.00	0.00	0.00	0.00	0.00	0.00	0.00	0.00	0.00	0.00
Water Indoor	0.00	0.00	0.00	0.00	0.00	0.00	0.00	0.00	0.00	0.00	0.00	0.00
Water Outdoor	0.00	0.00	0.00	0.00	0.00	0.00	0.00	0.00	0.00	0.00	0.00	0.00

#### Operational Mobile Mitigation

Project Setting:

Mitigation	Category	Measure	% Reduction	Input Value 1	Input Value 2	Input Value 3
No	Land Use	Increase Density	0.00			
No	Land Use	Increase Diversity	-0.01	0.13		
No	Land Use	Improve Walkability Design	0.00			
No	Land Use	Improve Destination Accessibility	0.00			
No	Land Use	Increase Transit Accessibility	0.25			
No	Land Use	Integrate Below Market Rate Housing	0.00			
	Land Use	Land Use SubTotal	0.00			

**Fresno County 18-Unit SFR Project**

**EMFAC Off-Model Adjustment Factors for Gasoline Light Duty Vehicle to Account for the SAFE Vehicle Rule Not Applied**

No	Neighborhood Enhancements	Improve Pedestrian Network			
No	Neighborhood Enhancements	Provide Traffic Calming Measures			
No	Neighborhood Enhancements	Implement NEV Network	0.00		
	Neighborhood Enhancements	Neighborhood Enhancements Subtotal	0.00		
No	Parking Policy Pricing	Limit Parking Supply	0.00		
No	Parking Policy Pricing	Unbundle Parking Costs	0.00		
No	Parking Policy Pricing	On-street Market Pricing	0.00		
	Parking Policy Pricing	Parking Policy Pricing Subtotal	0.00		
No	Transit Improvements	Provide BRT System	0.00		
No	Transit Improvements	Expand Transit Network	0.00		
No	Transit Improvements	Increase Transit Frequency	0.00		
	Transit Improvements	Transit Improvements Subtotal	0.00		
		Land Use and Site Enhancement Subtotal	0.00		
No	Commute	Implement Trip Reduction Program			
No	Commute	Transit Subsidy			
No	Commute	Implement Employee Parking "Cash Out"			
No	Commute	Workplace Parking Charge			
No	Commute	Encourage Telecommuting and Alternative Work Schedules	0.00		
No	Commute	Market Commute Trip Reduction Option	0.00		
No	Commute	Employee Vanpool/Shuttle	0.00		2.00

**Fresno County 18-Unit SFR Project**

**EMFAC Off-Model Adjustment Factors for Gasoline Light Duty Vehicle to Account for the SAFE Vehicle Rule Not Applied**

No	Commuter	Provide Ride Sharing Program			
	Commuter	Commuter Subtotal	0.00		
No	School Trip	Implement School Bus Program	0.00		
		Total VMT Reduction	0.00		

**Area Mitigation**

Measure Implemented	Mitigation Measure	Input Value
No	Only Natural Gas Hearth	
No	No Hearth	
No	Use Low VOC Cleaning Supplies	
No	Use Low VOC Paint (Residential Interior)	150.00
No	Use Low VOC Paint (Residential Exterior)	150.00
No	Use Low VOC Paint (Non-residential Interior)	150.00
No	Use Low VOC Paint (Non-residential Exterior)	150.00
No	Use Low VOC Paint (Parking)	150.00
No	% Electric Lawnmower	
No	% Electric Leafblower	
No	% Electric Chainsaw	

**Energy Mitigation Measures**

Measure Implemented	Mitigation Measure	Input Value 1	Input Value 2
No	Exceed Title 24		

**Fresno County 18-Unit SFR Project**

**EMFAC Off-Model Adjustment Factors for Gasoline Light Duty Vehicle to Account for the SAFE Vehicle Rule Not Applied**

No	Install High Efficiency Lighting		
No	On-site Renewable		

Appliance Type	Land Use Subtype	% Improvement
ClothWasher		30.00
DishWasher		15.00
Fan		50.00
Refrigerator		15.00

**Water Mitigation Measures**

Measure Implemented	Mitigation Measure	Input Value 1	Input Value 2
No	Apply Water Conservation on Strategy		
No	Use Reclaimed Water		
No	Use Grey Water		
No	Install low-flow bathroom faucet	32.00	
No	Install low-flow Kitchen faucet	18.00	
No	Install low-flow Toilet	20.00	
No	Install low-flow Shower	20.00	
No	Turf Reduction		
No	Use Water Efficient Irrigation Systems	6.10	
No	Water Efficient Landscape		

**Solid Waste Mitigation**

### Fresno County 18-Unit SFR Project

#### EMFAC Off-Model Adjustment Factors for Gasoline Light Duty Vehicle to Account for the SAFE Vehicle Rule Not Applied

Mitigation Measures	Input Value
Institute Recycling and Composting Services Percent Reduction in Waste Disposed	

GROUNDWATER CONDITIONS AT AND IN THE VICINITY OF  
ELEGANTE ESTATES, FRIANT ROAD AND WILLOW AVENUE

Draft Report-For Review Purposes Only

prepared for  
Elegante Estates, LLC  
Fresno, California

GPA566; AA3850; TTM  
6420; VA 4140

by  
Kenneth D. Schmidt and Associates  
Groundwater Quality Consultants  
Fresno, California

August 2022



## TABLE OF CONTENTS

	<u>Page</u>
LIST OF TABLES	iii
LIST OF ILLUSTRATIONS	iv
INTRODUCTION	1
TOPOGRAPHIC CONDITIONS	
SUBSURFACE GEOLOGIC CONDITIONS	4
Depth to Base of Alluvium	4
Subsurface Geologic Cross Section A-A'	4
Subsurface Geologic Cross Section B-B'	7
WATER SUPPLY WELLS	9
On-Site Wells	9
Community Wells	9
Other Wells	11
WATER LEVELS	11
Depth to Water	11
Water-Level Elevations and Direction of Groundwater Flow	12
Water-Level Changes	14
WELL PRODUCTION	17
Pumping Rates and Specific Capacities	17
1995 72-Hour Pump Test on Well at Willow Ridge	18
72-Hour Pump Test on Lower Well	18
72-Hour Pump Test on Upper Well	21
AQUIFER CHARACTERISTICS	26
Specific Yield	26
Transmissivity	26
Storage Coefficient for Lower Water Producing Zone	27
SOURCES OF GROUNDWATER RECHARGE	27
Little Dry Creek Seepage	27
Groundwater Inflow	27
Septic Tank Effluent	28
Urban Storm Runoff	28

TABLE OF CONTENTS  
(Continued:)

	<u>Page</u>
SOURCES OF GROUNDWATER DISCHARGE	28
Pumpage	28
Groundwater Outflow	29
GROUNDWATER QUALITY	29
CSA 44-D Wells	29
On-site Wells	31
WATER BALANCES	32
Historical Water Use at Project Site	32
Water Use for Proposed Project	33
STORAGE CAPACITY	34
Amount of Groundwater Available	34
Expected Availability of Water in the Future	34
Predicted Regional Water-Level Decline	34
Feasibility of Individual Wells	35
Anticipated Depths of Individual Wells	35
Chemical Quality	35
Type of Well to be Used	35
Adequacy of Source Data	35
General Plan Policy PF-C.17	36
Impacts on Other Wells	36
SUMMARY AND CONCLUSIONS	36
REFERENCES	37
APPENDIX A	DRILLERS LOGS FOR SELECTED WELLS
APPENDIX B	RESULTS OF 1995 PUMP TEST AT WILLOW RIDGE
APPENDIX C	PUMP TEST RESULTS FOR LOWER WELL
APPENDIX D	PUMP TEST RESULTS FOR UPPER WELL
APPENDIX E	CHEMICAL ANALYSES OF WATER FROM PUMP TESTED WELLS
APPENDIX F	CHEMICAL ANALYSES OF WATER FROM CSA 44-D WELLS

LIST OF TABLES

<u>No.</u>	<u>Title</u>	<u>Page</u>
1	Construction Data for Selected Wells	10
2	Water-Level Measurements for July 2022	15
3	Summary of Aquifer Test Results	
4	Chemical Analyses of Water from Wells	30

LIST OF ILLUSTRATIONS

<u>No.</u>	<u>Title</u>	<u>Page</u>
1	Location of Project Site and Study Area	2
2	Topography of Elegante Estates	3
3	Depth to Base of Alluvium	5
4	Subsurface Geologic Cross Section A-A'	6
5	Subsurface Geologic Cross Section B-B'	8
6	Long-Term Water-Level Hydrographs	16
7	Drawdown in Lower Well for Constant Rate Test	20
8	Water-Level Recovery for Lower Well	22
9	Drawdown in Upper Well for Constant Rate Test	23
10	Water-Level Recovery for Upper Well	25

# GROUNDWATER CONDITIONS AT AND IN THE VICINITY OF ELEGANTE ESTATES, FRIANT ROAD AND WILLOW AVENUE

## INTRODUCTION

A 36-acre site south of Friant Road and west of Willow Avenue is proposed to be split into 18 two-acre lots. An individual domestic well and septic tank disposal system would be used for each lot. The proposed development is north and west of the Willow Ridge Subdivision and west of the Monte Verde Development, which is located east of Willow Avenue. Figure 1 shows the location of the study area for this report, which extends south to Silaxo Lane, west to Chestnut Avenue, east to about half a mile east of north Willow Avenue, and north to near the easterly extension of Avenue 12-1/2. Information on groundwater conditions in the vicinity of the project was provided by a report by Kenneth D. Schmidt and Associates (KDSA) in August 1995 for the Willow Ridge Subdivision.

## TOPOGRAPHIC CONDITIONS

Figure 2 shows the topographic conditions at Elegante Estates. Land surface elevations range from 310 feet above mean sea level near Friant Road to 404 feet above mean sea level at the top of the bluff. Drainage is primarily to the north toward Friant Road. There is a fairly large drainage just west of Willow Avenue, and several smaller drainages along Friant Road to the west.

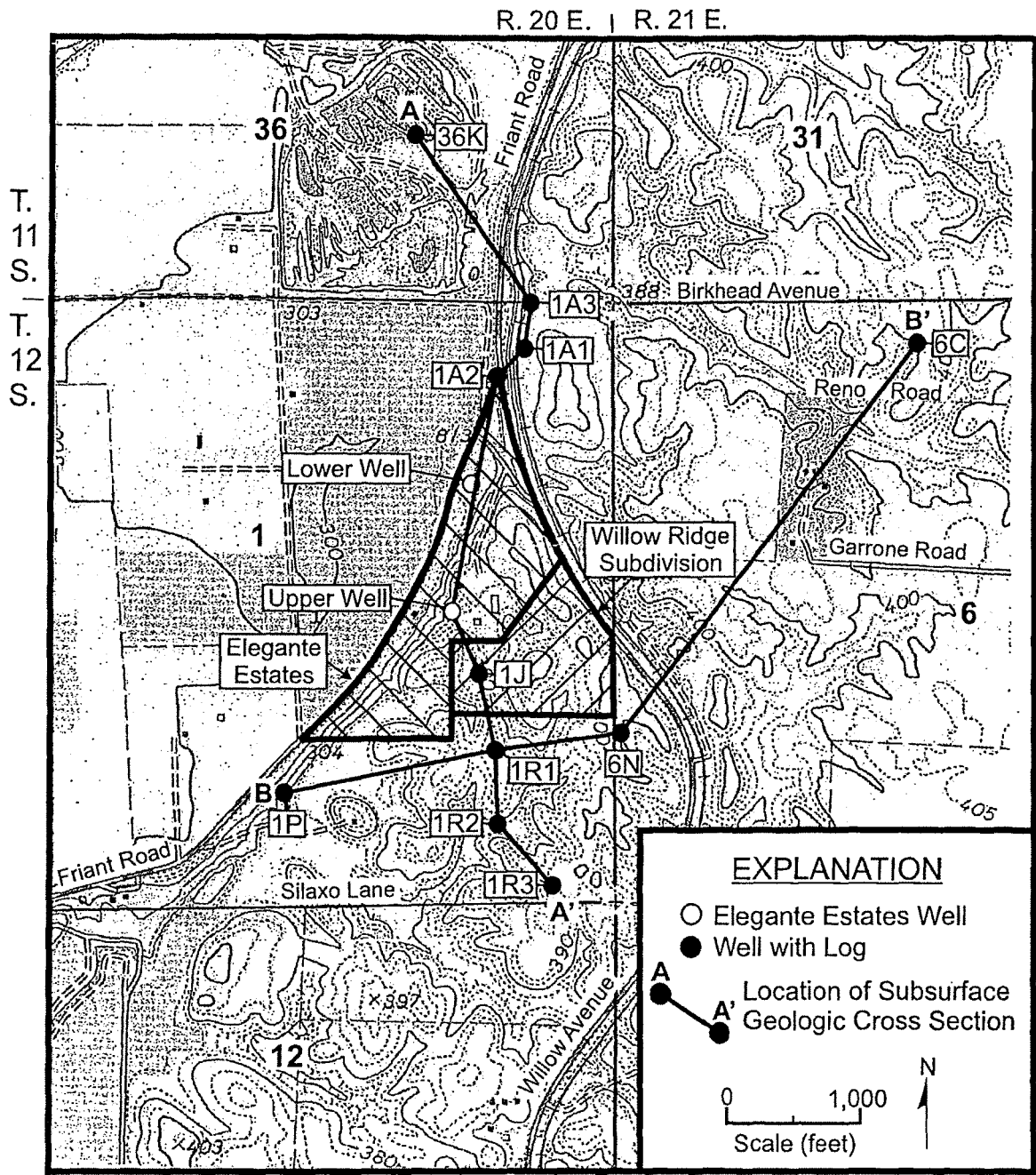

FIGURE 1-LOCATION OF PROJECT SITE, STUDY AREA, SELECTED WELLS AND SUBSURFACE GEOLOGIC CROSS SECTIONS

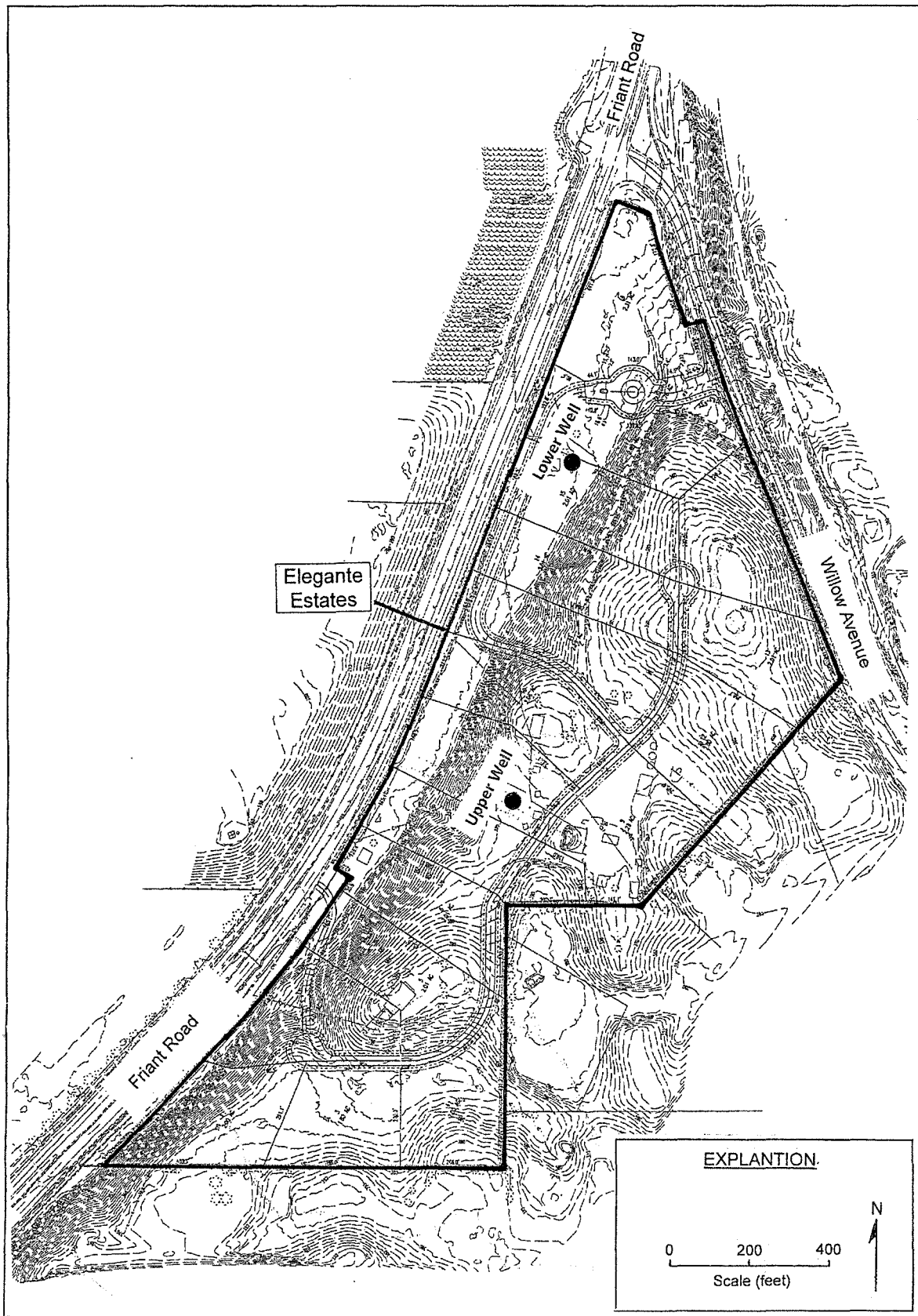

FIGURE 2-TOPOGRAPHY FOR ELEGANTE ESTATES

## SUBSURFACE GEOLOGIC CONDITIONS

### Depth to Base of the Alluvial Deposits

Figure 3 shows contours of the depth to the base of the alluvial deposits in and near the study area. The alluvial deposits are underlain by granitic rocks or schist. The depth ranges from less than 350 feet to the east of Willow Avenue, and increases to more than 450 feet to the west. The alluvial deposits comprise the aquifer in the area.

### Subsurface Geologic Cross Section A-A'

Subsurface Geologic Cross Section A-A' (Figure 4) extends from the north, north of the project site in the floodplain of the San Joaquin River, through Elegante Estates, to the south to near E. Silaxo Lane (Figure 1). Depths of wells along this section range from 200 to 450 feet. Two wells along this section (Upper Well and 1J) penetrated the base of the alluvial deposits. The Upper Well at the project site encountered the top of schist at 455 feet in depth and well 1J encountered the top of granitic rock at a depth of 449 feet.

An extensive clay layer is found along the north part of the cross section between about 100 and 150 feet in depth beneath the floodplain of the San Joaquin River. Along the south part of the section, the top of the clay extends from about 150 to



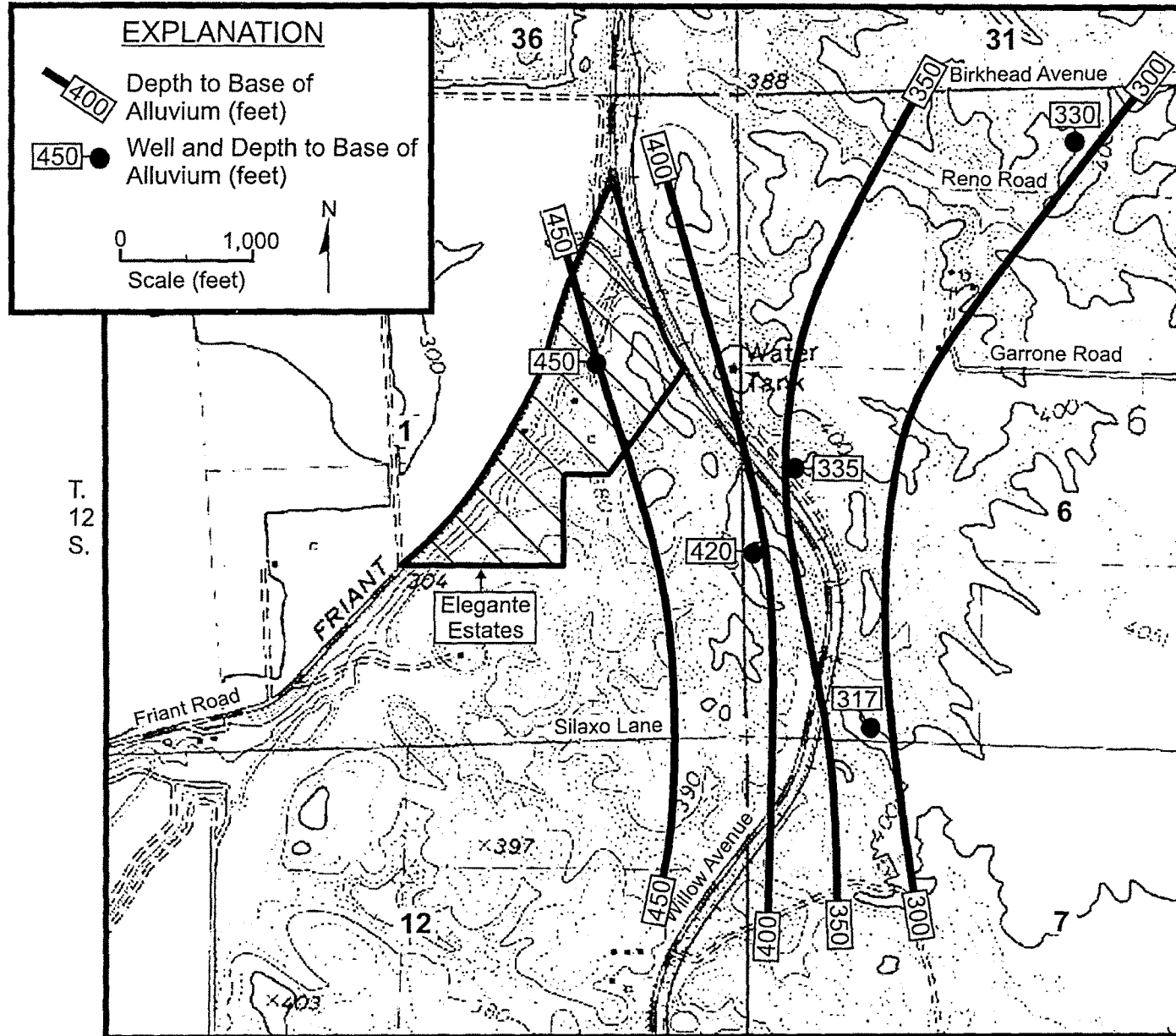
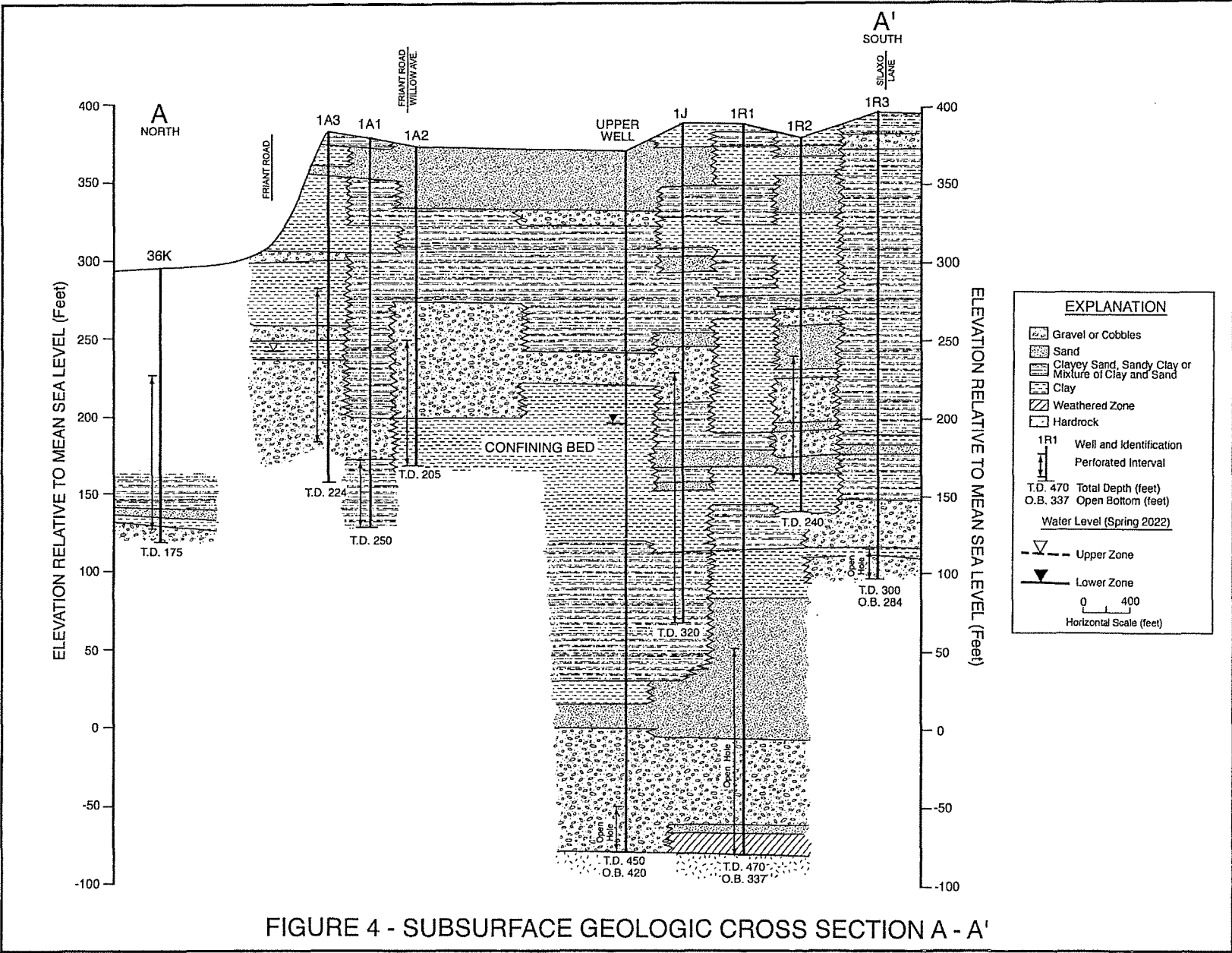

FIGURE 3-DEPTH TO BASE OF ALLUVIUM



215 feet in depth beneath the bluff. The thickness of the clay ranges from about 50 feet beneath the north part of the cross section to between 50 and 200 feet beneath the south part of the section. This clay separates two primary water-producing zones. Cobbles are common in the upper water producing zone along this section.

#### Subsurface Geologic Cross Section B-B'

Subsurface Geologic Cross Section B-B' (Figure 5) extends from the west near Friant Road to the east, east of Willow Avenue and north of E. Silaxo Lane. Depths of the wells along this section range from 330 to 470 feet. The base of the alluvial deposits was encountered at two of these wells (1R and 6C). At Well 1R the base of the alluvium was 455 feet deep, and at well 6C the base was 330 feet deep. The well defined clay layer was found at all wells along this cross section. The thickness of this clay ranges from about 110 feet to the west at Well 1P to about 80 feet thick at Well 6C. The top of the clay at most wells along the section ranges from 150 to 210 feet deep. The upper water producing zone is primarily sand, except to the east where cobbles are also present. The top of the lower water-producing zone ranges from about 240 feet deep to the east to from 305 to

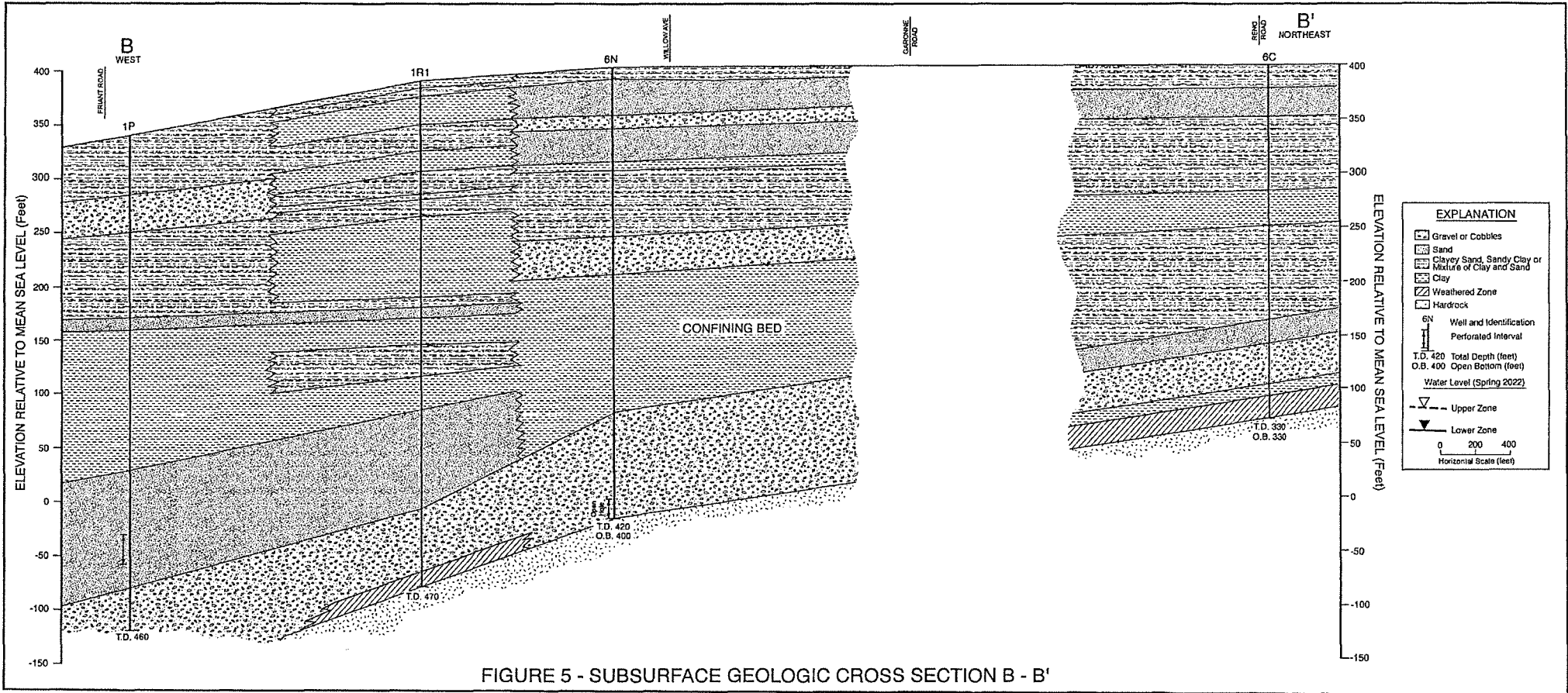

320 feet deep along the rest of the section to the west. Cobbles are common in the lower water producing zone.

#### WATER SUPPLY WELLS

Table 1 shows construction data for selected wells in the vicinity.

##### On-Site Wells

There are three on-site wells at the proposed project site. The Lower Well is used for a residence and was used for irrigation of about seven acres of pasture. A completion report is not available for this well, but it was measured to be 92 feet deep in early June 2022. It taps the shallow water producing zone. The active Upper Well is used for three residences. A completion report is available for this well. It is 450 feet deep and encountered the top of the granitic rock at a depth of 449 feet. The well is cased to a depth of 420 feet, is an open bottomed well, and taps the lower water producing zone. It taps about 80 feet of cobbles. There is an unused well about 25 feet from the Upper Well that taps the upper zone. A completion report is not available for this well, and it was replaced by the Upper Well.

##### Community Wells

Community wells were developed for the Monte Verde Development, east of the project site. Water is provided from two wells by County of Fresno CSA 44D. These wells range in depth

TABLE 1-CONSTRUCTION DATA FOR SELECTED WELLS

<u>Well I.D.</u>	<u>Date Completed</u>	<u>Total Depth (feet)</u>	<u>Cased Depth (feet)</u>	<u>Perforated or Open Interval (feet)</u>	<u>Annular Seal (feet)</u>
Lower On-Site Well	N.A.	92	92	N.A.	N.A.
Active Upper On-Site Well	10/20	450	420	420-450	0-20
Unused Upper On-Site Well	N.A.		N.A.	N.A.	N.A.
Monte Verde Well 1	12/90	330	256	140-249	0-20
Monte Verde Well 2	12/90	335	335	200-335	0-20

Information for Active Upper On-Site Well and Monte Verde wells from well completion reports.

from 330 to 335 feet and tap the lower water-producing zone, which contains cobbles at those locations. Well No. 1 pumpage 250 gpm and Well No. 2 pumpage 340 gpm. The Copper River Ranch development is served by several City of Fresno wells along Friant Road. These wells also tap the deep zone.

#### Other Wells

Private domestic wells are used at the Willow Ridge Subdivision and to the west in the "Pill Hill" area. The nine lots in the Willow Ridge Subdivision are two acres in size. In the Pill Hill area, most lots to the east are five acres in size and to the west two acres in size. Some private domestic wells tap the upper water-producing zone and others tap the lower water producing zone. There are two water supply wells and four shallow monitor wells at the CEMEX plant site, north of the project site.

#### WATER LEVELS

##### Depth to Water

The bluff on the south side of the river is about 90 feet higher than the lands beneath the San Joaquin River floodplain to the north. Water levels are much deeper beneath this bluff than beneath the floodplain to the north. In the vicinity there are two water producing zones separated by a significant confin-

ing bed. The water levels in the upper water producing zone are commonly about 30 to 50 feet higher than in the lower zone.

This means that there is a downward component of groundwater flow in the area. Near Friant Road, depth to water is about 70 to 75 feet, whereas near the upper part of the bluff, depth to water in the upper water-producing zone is about 125 to 130 feet. Depth to water in the lower water-producing zone is about 180 to 200 feet beneath the higher parts of the bluff at the project site.

#### Water-Level Elevations

KDSA (1995) provided a water-level elevation map for the vicinity for November 1993. This map was based on water-level measurements for a number of wells at the Copper River Ranch and a number of City of Fresno wells. Water-level elevations ranged from greater than 260 feet above mean sea level to the east near Willow Avenue to less than 220 feet near Copper Avenue and Friant Road. A west-southwesterly direction of groundwater flow was indicated.

A number of water-level elevation maps were prepared for the Kings Sub-basin Groundwater Sustainability Plan (GSP). A number of these maps for spring measurements were evaluated in the vicinity of Elegante Estates. Most of these maps in recent decades indicated a southerly direction of groundwater flow. The



average water-level slope was about 17 feet per mile. Much of this groundwater flow originates from seepage from Little Dry Creek, northeast of the project site.

When water-level measurements for wells in the floodplain of the San Joaquin River are considered, they tend to indicate a southerly flow in the lower water-producing zone toward the project site. Thus recharge from San Joaquin River seepage is also a source of recharge to groundwater in the area.

In July 1995, two deep zone wells at the proposed Willow Ridge Subdivision at that time had static water levels ranging from 154 to 160 feet deep. In contrast, an upper zone well at that site had a static water level of only 125 feet deep at that time. On April 18, 2022, the lower on-site well had a depth to water of 72 feet, or a water-level elevation of about 240 feet above mean sea level. This is representative of the shallow water producing zone. On April 8, 2022, the upper on-site well had a depth to water of 181 feet, or a water-level elevation of about 190 feet above mean sea level. On April 1, 2022, depth to water in CSA 44D Well No. 1 and No. 2 was 185 feet. This indicates a downward head gradient and a downward flow of groundwater from the shallow water producing zone to the deep zone.

As part of this evaluation, water-level measurements were obtained from the County of Fresno and City of Fresno, and water

levels in several wells in the Willow Ridge Subdivision were also measured in Spring 2022. Water Levels in the two on-site wells were measured by Wellco Pump of Raymond on April 8, 2022.

Table 2 shows water-level data for July 12, 2022. Depth to water ranged from 73 to 238 feet. Water-level elevations for wells tapping the upper zone ranged from 239 to 241 feet above mean sea level. Representative water-level elevations for wells tapping the lower zone ranged from 174 to 179 feet above mean sea level.

#### Water-Level Changes

Water-level records for wells in the floodplain in the San Joaquin River north of the project site show a long-term stability of depth to water. Some of the west water-level records for the area south of the floodplain are for the CSA 44-D wells. Fresno County provided measurements for 2013-22. Figure 6 shows long-term hydrographs for the two CSA 44-D wells at Monte Verde. Weekly measurements were provided for 2014, and therefore monthly, measurements were provided. In 2016, the shallowest level on Well No. 1 was 180 feet on March 5, and the deepest was 223 feet on July 30, or a seasonal decline of 43 feet. A review of the shallowest measurements each year indicates falling levels from January 2013 to December 2014, and rising levels from

TABLE 2-WATER-LEVEL DATA FOR JULY 12, 2022

<u>Well No.</u>	<u>Measuring Point Elevation (feet)</u>	<u>Depth to Water (feet)</u>	<u>Water-Level Elevation (feet)</u>
Onsite Lower Well	312	73.0	239
Onsite Active Upper Well	371	197.3	174
Onsite Unused Upper Well	371	130.2	241
2880 E. Willow Ridge	390	148.8	241
2765E. Willow Ridge	380	237.8*	142*
12377 N. Willow Ridge	390	211.2	179
CSA 44D			

\* Not considered representative of the lower zone.

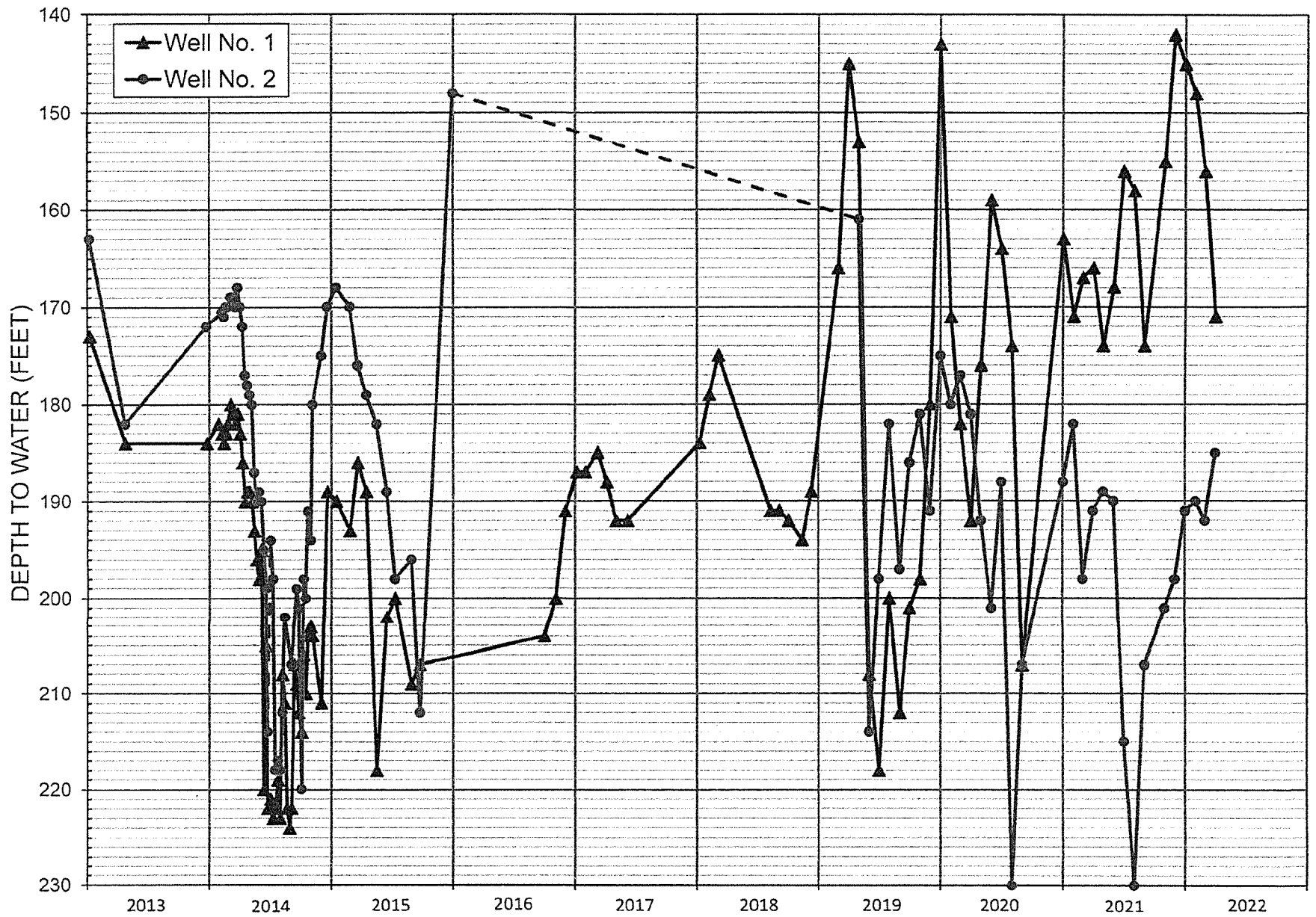

FIGURE 6 - WATER-LEVEL HYDROGRAPHS FOR FRESNO COUNTY WATERWORKS DISTRICT 44-D WELLS

January 2017 to December 2021. Thus even through the pumpage generally increased from 2015-16 to 2021, the water levels in this well did not decline. When pumping, this well produced about 250 gpm. In contrast, records for Well No. 2 indicate a decline from about 173 feet in January 2013 to 190 feet in February 2022. This decline averaged about 27 feet on eight years, or about 3.4 feet per year. When pumping, this well produced about 340 gpm.

#### WELL PRODUCTION

##### Pumping Rates and Specific Capacities

Some of the largest capacity wells in the vicinity are capable of pumping more than 500 gpm. Most private domestic wells produce in the range of about 20 to 50 gpm. In April 2022, the two on-site wells were pumped test by Wellco Pump of Raymond. The Upper Well produced 38 gpm and the Lower Well produced 49 gpm. The Upper Well has a 6-inch diameter casing and the Lower Well has a 12-inch diameter casing. For the lower zone Upper Well the specific capacity was 3.2 gpm per foot. For the lower zone well pump tested at the proposed Willow Ridge Subdivision in July 1995, the pumping rate was 36 gpm and the specific capacity was 5.2 gpm per foot.

Records for the CSA 44-D wells indicate pumping rates of about

250 gpm for Well No. 1 and 340 gpm for Well No. 2.

1995-Pump Test on  
Wells at Willow Ridge

KDSA (1995) reported on the results of a 72-hour aquifer test on a lower zone well at the proposed Willow Ridge Subdivision in July 1995. The well was an open bottomed well cased to a depth of 335 feet. The drawdown measurements indicated a specific capacity of 5.2 gpm per foot and aquifer transmissivity of 7,300 gpd per foot. Corrected recovery measurements for the pumped well (open bottomed well 335 feet deep) indicated a transmissivity of 9,500 gpd per foot. Appendix B contains the KDSA report on the 1995 pump test.

72-Hour Pump Test on Lower Well

Measurements for the pump test on the Lower Well are provided in Appendix C.

Drawdown Measurements

The static water level in the Lower Well was 72.5 feet deep prior to pumping. Pumping started at 9:10 AM on June 7, 2022 and continued until 9:10 AM on June 10, 2022. A constant rate test was conducted for the first eight hours. A total of 20,180

gallons was pumped and the average pumping rate during this period was 42.1 gpm.

The pumping level at the end of eight hours of pumping was 88.2 feet deep. The drawdown was 15.7 feet and the specific capacity was 2.7 gpm per foot. Figure 7 shows the drawdown for the Lower Well for the constant rate test. Within ten minutes, the pumping level stabilized. These measurements indicated a transmissivity of 765 gpd per foot. The constant head test was conducted for the rest of the pumping period. The pumping level was kept about 88 feet deep.

A total of 168,310 gallons was pumped during the entire test, and the average pumping rate was 39.0 gpm. At the end of pumping, the pumping level was 88.2 feet. The drawdown was 15.7 feet and the specific capacity was 2.4 gpm per foot.

Depth to water in the Upper Well was 190.8 feet deep prior to pumping of the Lower Well. At the end of the pumping period, depth to water in the Upper Well was 192.4 feet. The deeper level was caused by temporary pumping of the Upper Well. Prior to this pumping, the water level was 190.2 feet deep at 4:00 PM on June 8, 2022. There was no indication of a drawdown in the Upper Well due to pumping of the Lower Well. This was expected because it does not tap the same strata as the pumped well.

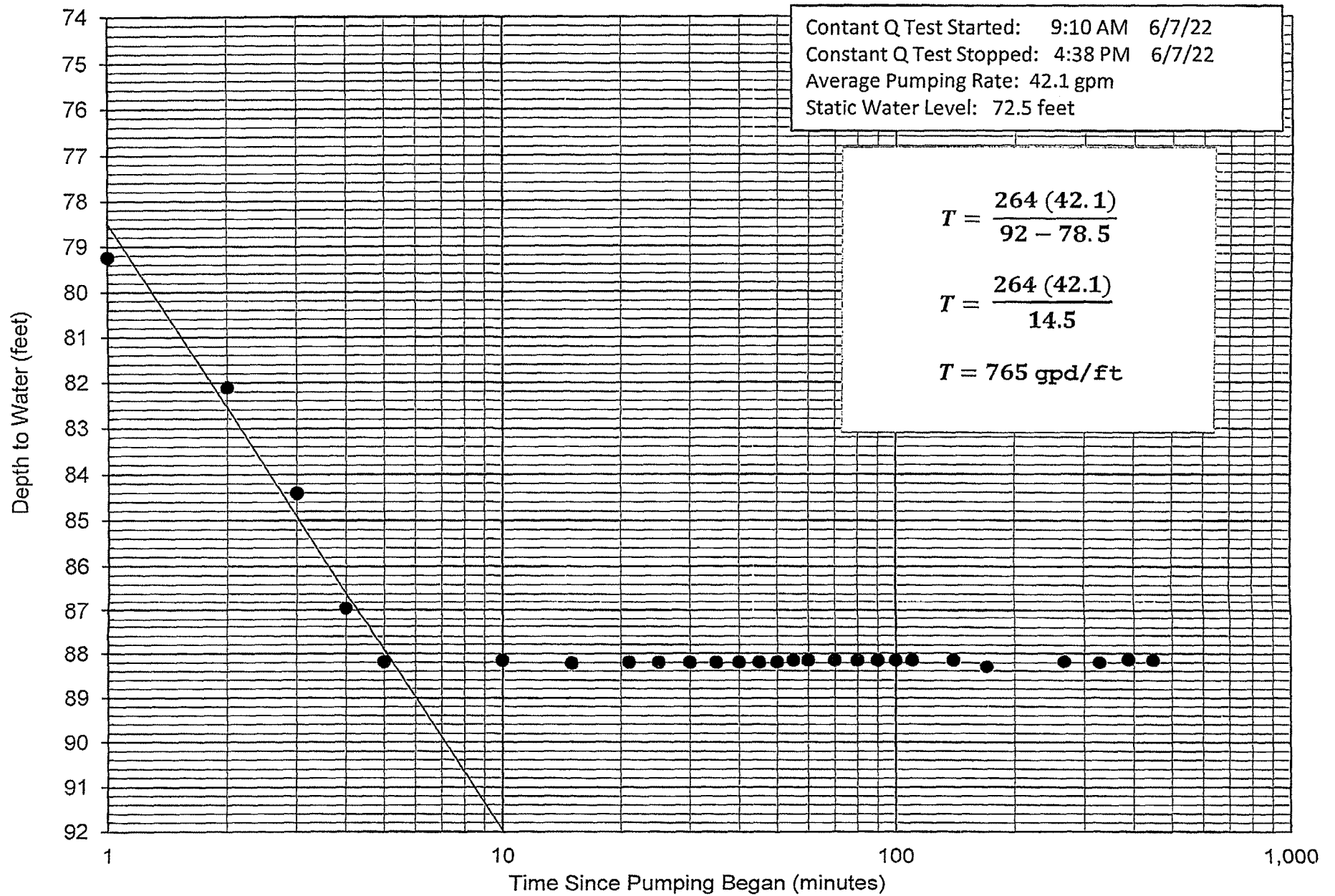

FIGURE 7-DRAWDOWN IN LOWER WELL FOR CONSTANT RATE TEST



### Recovery Measurements

Figure 8 shows water-level recovery for the Lower Well. The water level in the Lower Well fully recovered within one hour after pumping stopped. Recovery measurements for the Lower Well indicated a transmissivity of 590 gpd per foot. The best value for the test was the average of the drawdown and recovery values, or 680 gpd per foot. Depth to water in the Upper Well remained the same for about two hours after pumping stopped, indicating no influence due to pumping of the Lower Well.

### 72-Hour Pump Test on Upper Well

Measurements of the pump test on the Upper Well are provided in Appendix D.

### Drawdown Measurements

The static water level in the Upper Well was 196.0 feet deep prior to pumping. Pumping started at 9:00 AM on June 14, 2022 and continued until 9:00 AM on June 17, 2022. A constant rate test was conducted for the first eight hours. A total of 17,460 gallons was pumped and the average pumping rate during this period was 36.4 gpm. The pumping level at the end of the eight hours of pumping was 202.4 feet deep. The drawdown was 6.4 feet and the specific capacity was 5.7 gpm per foot. Figure 9 shows the drawdown for

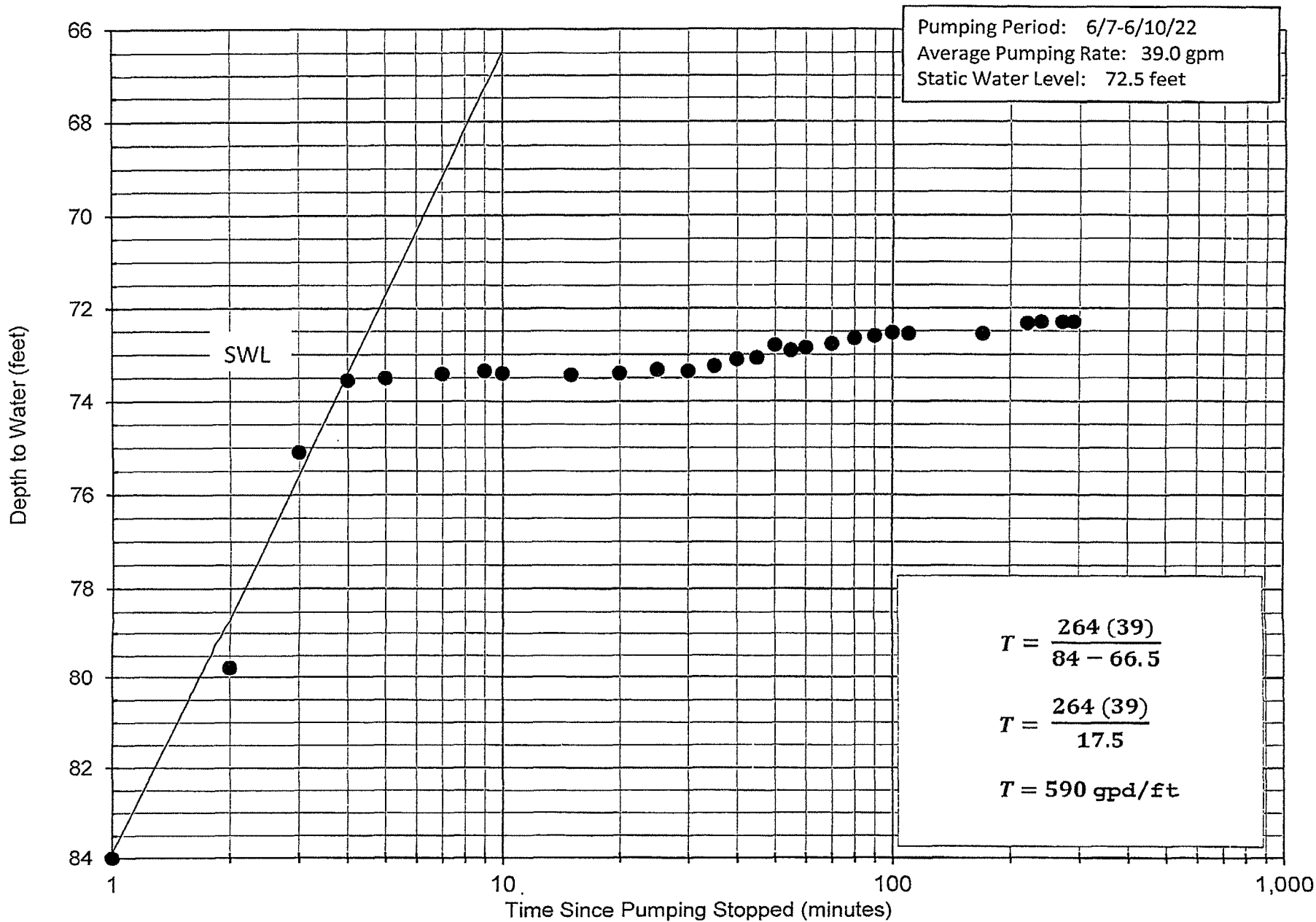

FIGURE 8-WATER-LEVEL RECOVERY FOR LOWER WELL

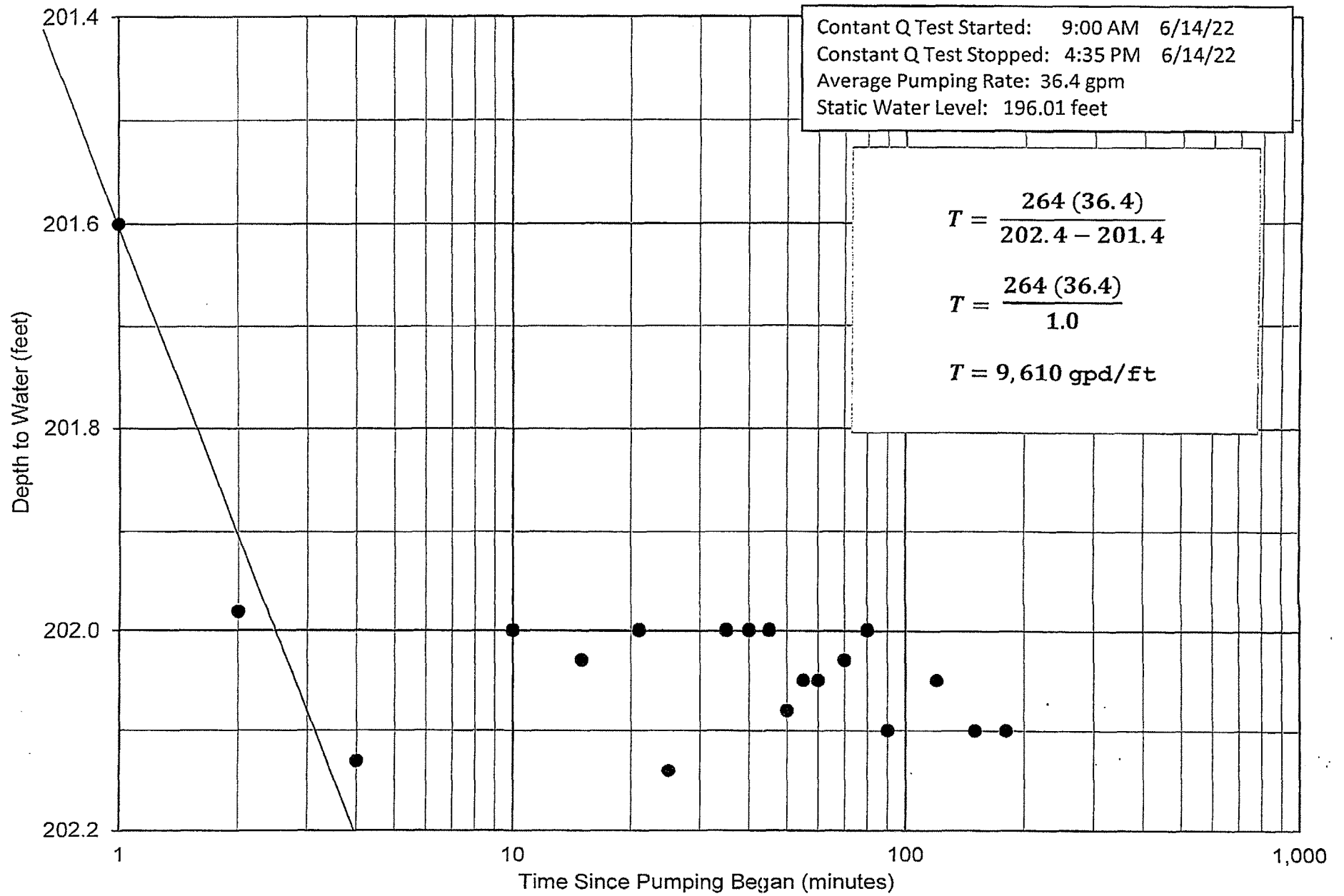

FIGURE 9-DRAWDOWN IN UPPER WELL FOR CONSTANT RATE TEST

the Upper Well for the constant rate test. These measurements indicated a transmissivity of 9,610 gpd per foot. The constant head test was conducted for the rest of the pumping period. The pumping levels were kept between about 202 and 203 feet during this period. The pumping level was 203.2 feet deep at the end of the 72-hour test. The specific capacity was 4.6 gpm per foot. For the whole test a total of 145,000 gallons were pumped, and the average pumping rate was 33.6 gpm.

Depth to water in the Lower Well was 72.4 feet deep prior to pumping of the Upper Well. At the end of the pumping period, depth to water in the Lower Well was 72.7 feet, indicating no significant drawdown due to pumping of the Upper Well.

An unused upper zone well was found about 25 feet from the Upper Well. This well has a 10-inch diameter casing and was apparently replaced by the Upper Well. The static level in this well prior to pumping of the Upper Well was 130.5 feet deep. At the end of pumping the Upper Well, the depth to water in this unused well was 130.3 feet, indicating no influence due to pumping of the Upper Well.

#### Recovery Measurements

Figure 10 shows water-level recovery for the Upper Well. After 380 minutes of recovery, depth to water was 200.1 feet, compared to the static level prior to pumping (196 feet deep). About

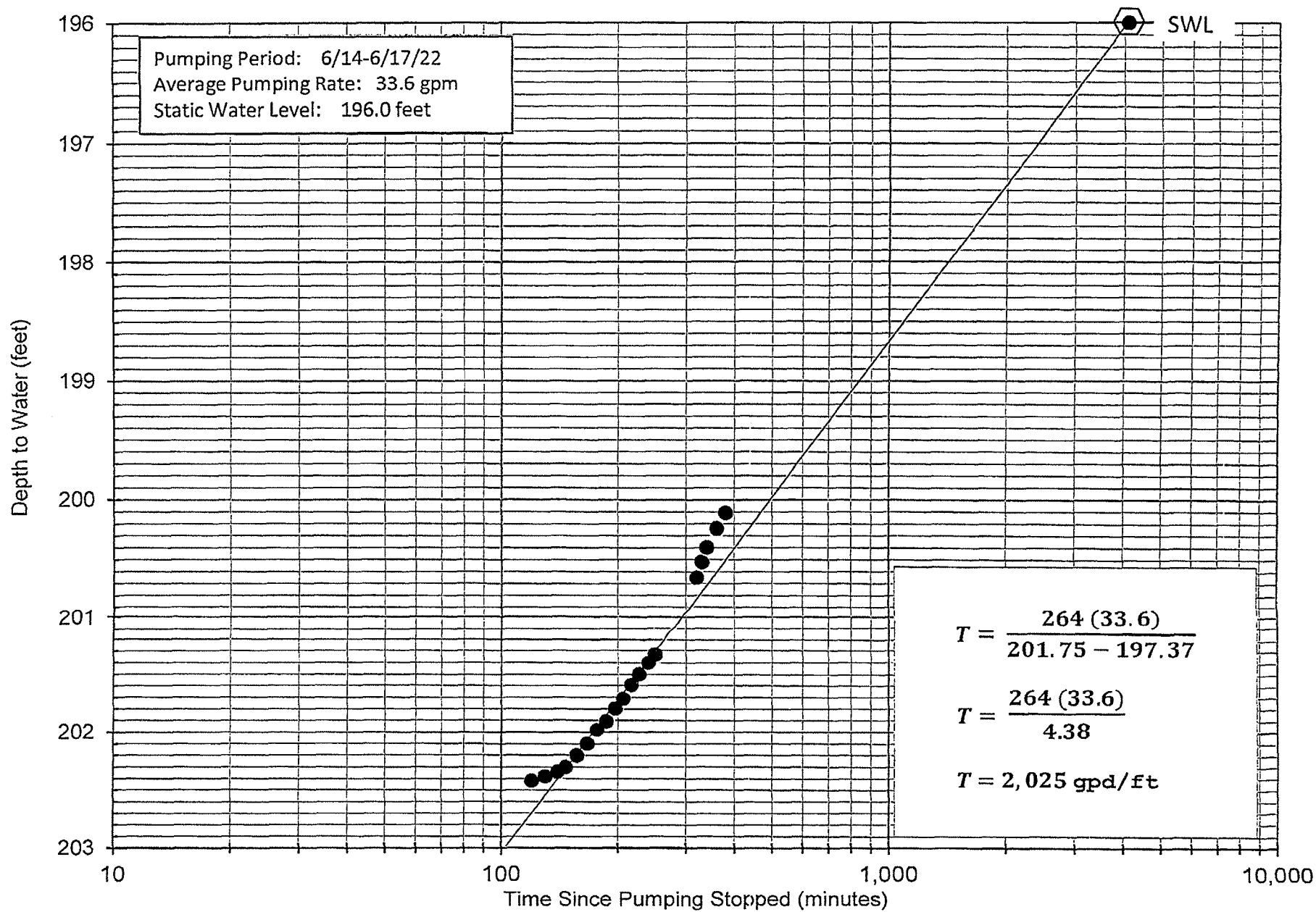

FIGURE 10-WATER-LEVEL RECOVERY FOR UPPER WELL

380 minutes after pumping of the Upper Well had stopped, pumping had to be resumed to supply livestock on the property. Projections indicate full recovery would have occurred about 1.3 days after pumping stopped. Recovery measurements for the Upper Well indicated a transmissivity of 2,025 gpd per foot, indicated to be the best value for the test. Water levels in the two upper zone observation wells did not change after pumping of the Upper Well stopped, confirming no influence on these wells.

#### AQUIFER CHARACTERISTICS

##### Specific Yield

The specific yield is applicable to the upper water producing zone above the confining bed. Examination of the two subsurface geologic cross sections indicates an average specific yield of about 12 percent.

##### Transmissivity

The Lower Well tapped only about 19 feet of saturated deposits in the upper zone. The upper zone is estimated to have about 125 feet of saturated deposits at this location. Based on the pump test results for the Lower Well, the best value for the aquifer transmissivity for the upper water producing zone is 680 gpd per foot x 125/19, or 4,500 gpd per foot. This value only

applies to the lower topographic area near Friant Road. Based on the pump test results for the Upper Well (2,025 gpd per foot) and the Willow Ridge 1995 test (9,600 gpd per foot), the best value for the aquifer transmissivity of the lower zone is 5,800 gpd per foot.

#### Storage Coefficient for Lower Zone

The storage coefficient for the lower zone was determined for the 1995 pump test on the well as the Willow Ridge subsurface. The best value was 0.004.

### SOURCES OF GROUNDWATER RECHARGE

#### Little Dry Creek Seepage

Based on water-level elevation maps, Little Dry Creek is up-gradient of the project site.

#### Groundwater Inflow

Groundwater inflow is primarily indicated to be from Dry Creek seepage. KDSA (1995) estimated that the groundwater inflow to the proposed Willow Ridge subdivision was about 50 acre-feet per year.

Darcy's Law was used to estimate groundwater inflow to the project site. There is an inflow in both the upper and the lower water-producing zones.

For the lower zone, the width of inflow is about 1,900 feet using a transmissivity of 5,800 gpd per foot and average water level slope of 17 feet per mile, the amount of groundwater flow is about 40 acre-feet per year.

For the upper zone, water-level elevations indicate little differences from place to place, and thus this inflow is small and could not be calculated.

#### Septic Tank Effluent

About one-half of the pumpage for the project is estimated to be for inside use, and most of the water would be recharged through septic tank systems.

#### Urban Storm Runoff

It is proposed that one or more stormwater basins would be used to recharge storm runoff for the project in the lower part of the property near Friant Road. The goal would be to recharge about 40 percent of the average rainfall of 13 inches per year.

### SOURCES OF GROUNDWATER DISCHARGE

#### Pumpage

Pumpage records were obtained for the two CSA 44-D wells that



service the Monte Verde Development. Pumpage records for 2015 to 2021 indicated annual pumpage ranging from 214 acre-feet in 2016 to 289 acre-feet in 2021. The average annual pumpage during 2015-21 was about 250 acre-feet per year. In 2021, 125 connections were present, and the average pumpage was 2.0 acre-feet per lot.

Wastewater from the Monte Verde Development is treated and recycled for landscape irrigation.

Pumpage for the Willow Ridge subdivision isn't measured, but is estimated to be about 20 acre-feet per year.

#### Groundwater Outflow

There is groundwater outflow in both upper and lower water-producing zones. This amount of outflow hasn't been quantified.

### GROUNDWATER QUALITY

#### CSA 44-D Wells

Chemical analyses are available for a wide number of constituents in water from the CSA 44-D wells for February-March, 2020. Complete Title 22 drinking water standards analyses are available (Table 4). Total dissolved solids (TDS) concentrations ranged from 260 to 290 mg/l, and the waters were of the mixed

TABLE 4-CHEMICAL ANALYSES OF WATER FROM WELLS

Constituent (mg/l)	On-Site Lower	On-Site Upper	CSA 44-D Well No. 1	CSA 44-D Well No. 2	MCL
Calcium	61	30	31	33	
Magnesium	21	9	11	12	
Sodium	34	38	29	31	
Potassium	3	3	<1	<1	
Bicarbonate	342	122	195		
Sulfate	12	21	15		
Chloride	<1	66	22		
Nitrate-Nitrogen	0.7	0.8		2.4	10
pH	7.2	7.6	7.5		
Electrical Conductivity (micromhos/cm @ 25°C)	620	450	400		
Total Dissolved Solids (@ 180°C)	370	300	290		
Iron	<0.1	<0.1	<1		0.3
Manganese	<0.01	0.017	<0.01		0.05
Arsenic (ppb)	1.9	5.9	3.7		10
Hexavalent Chromium (ppb)	<0.5	<0.5	1.1		10
Gross Alpha Activity (picocuries/liter)	3.5	0.5	2.6	1.6	15
DBCP (ppb)	<0.01		<0.01	<0.01	0.2
EDB (ppb)	<0.01		<0.02	<0.02	0.05
1,2,3-TCP (ppt)	<5	<5	<5	<5	5
Date	6/10/22	6/17/22	3/7/20	2/6/20	
Lab			Moore Twining	Moore Twining	

For on-site well, inorganic and trace organic analyses by APPL, Inc. of Clovis and radiological analyses by FGL Environmental.

cation bicarbonate type. Nitrate-nitrogen concentrations ranged from 2.4 to 3.5 mg/l, less than the maximum contaminant level (MCL) of 10 mg/l. Arsenic concentrations ranged from 3.7 to 4.1 ppb, less than the MCL of 10 ppb. Concentration of iron, manganese, chromium, DBCP, EDB, and 1,2,3-TCP, and gross alpha activities were well below the respective MCLs. Concentrations of all constituents is the Title 22 drinking water standards were below the MCLs. In summary, the chemical quality of water from these wells was excellent for public supply.

#### On-site Wells

Water samples were collected from the two on-site wells near the end of the pump tests (Table 4). For the Lower Well, the TDS concentration was 370 mg/l and the water was of the calcium bicarbonate type. The nitrate-nitrogen concentration was less than 1 mg/l, well below the MCL of 10 mg/l. The arsenic concentration was 1.9 ppb, well below the MCL of 10 ppb. Concentrations of iron, manganese, hexavalent chromium, DBCP, EDB, and 1,2,3-TCP, and the gross alpha activity were below the respective MCLs.

For the Upper Well, the TDS concentration was 300 mg/l and the water was of the calcium-sodium bicarbonate type. The nitrate-nitrogen concentration was less than 1 mg/l, well below the MCL.

The arsenic concentration was 5.9 ppb, less than the MCL. Concentrations of iron, manganese, hexavalent chromium, and 1,2,3-TCP and the gross alpha activity were well below the representative MCLs.

#### WATER BALANCES

##### Historical Water Use at Project Site

A Google Earth map for September 2009 was used to estimate the irrigated pasture acreage at the site. This irrigation water was supplied from the Lower Well. The acreage of irrigated pasture was about 7 acres. Using DWR Bulletin 113-3 evapotranspiration values, the applied water for irrigated pasture was 6.5 feet per year (Table 34). Thus the applied water for irrigated pasture would have been about 46 acre-feet per year, supplied by pumpage from the Lower Well. The consumptive use of this applied irrigation water would be 3.1 acre-feet per acre per year, from Table 25 of DWR Bulletin 113-3. The consumptive use of applied irrigation water would have been about 22 acre-feet per year.

For the four residences at the site, the pumpage would be about one acre-foot per year from the Lower Well and three acre-feet per year from the Upper Well. About half of this pumpage would enter septic tank disposal systems and recharge the

groundwater. Of the remaining water (for outside use), about two-thirds would be consumed by evapotranspiration. The consumptive use for the four residences would total about 1.4 acre-feet per year.

In summary, the estimated historical pumpage at the site was about 50 acre-feet per year, mostly from pumpage from the upper zone. The consumptive use would have been about 23.4 acre-feet per year.

#### Water Use for Proposed Project

Pumpage for the proposed project is estimated to be about 1.2 acre-foot per lot per year, or a total of 22 acre-feet per year. This pumpage would be lower than that for the Monte Verde development, due to water conservation practices, such as desert landscaping and limited landscape irrigation. Of this amount, all of the inside use (0.5 acre-foot per year) and about one third of the landscape irrigation ( $0.7 \times 1/3$  acre-foot per year or 0.24 acre-foot), or a total of 0.74 acre-foot per lot per year, would be recharged. The consumptive use would be 0.45 acre-foot per year per lot, or a total of 8 acre-feet per year.

Storm runoff for the project would be recharged at one or more storm runoff basins near Friant Road. This would recharge an average of 0.45 acre-foot per lot, or about 8 acre-feet per year, and essentially balance the consumptive use for the project.

## STORAGE CAPACITY

### Amount of Groundwater Available

Sufficient groundwater would be available for the project, due to limitations on the amount of landscape irrigation, and recharge from septic tank systems and storm runoff. The homeowners would work with the North Kings GSA to address the existing groundwater overdraft in the area.

There is an average of about 270 feet of saturated deposits in the lower water-producing zone at the project site. Beneath the 36-acre area using an average specific yield of 12 percent, there are about 270 feet x 36 acres x 0.12, or 1,170 acre-feet of water in storage in the lower zone.

### Expected Availability of Water in the Future

Since the project would essentially be water neutral, and because the North Kings GSA would address the existing groundwater overdraft, groundwater is expected to be available for the project.

### Predicted Regional Water-Level Decline

Because the project would essentially be water neutral, the project would not cause a regional water-level decline.

### Feasibility of Individual Wells

Individual domestic wells tapping alluvial deposits are feasible at the project site. For lower topographic areas near Friant Road, groundwater in the upper zone could be tapped. For the higher topographic areas along the bluff, groundwater in the lower zone would be tapped.

### Anticipated Depths of Individual Wells

In lower topographic areas, depths of individual domestic wells would likely range from about 150 to 200 feet. In high topographic areas, depths of wells would range from about 250 to 450 feet.

### Chemical Quality

Based on analyses of water from the on-site wells and the CSA 44-D wells, the chemical quality of water from individual domestic wells is expected to be suitable for domestic use.

### Type of Well to be Used

Eight-inch diameter PVC cased alluvial wells drilled by the direct rotary method would be used for the new domestic wells.

### Adequacy of Source Data

The source data for this hydrogeologic report are rated as good.

#### General Plan Policy PF-C.17'

This proposed project would conform with the general plan policy. A detailed Section II-H hydrogeologic evaluation has been completed for the project and the project would be water neutral.

#### Impacts on Other Wells

The pump tests for wells tapping the upper and lower water producing zones at the project site indicated insignificant drawdowns in observation wells. Because of the limited consumptive use for each lot (for landscape irrigation), and recharge from septic tank systems and storm runoff, drawdown in the offsite wells would be insignificant.

#### SUMMARY AND CONCLUSIONS

Seventy-two hour pump tests were conducted on two on-site wells in June 2022. These are two main water producing zones beneath the site separated by a clay layer. The Lower Well is 92 feet deep and taps the upper zone. The Upper Well is 456 feet deep and taps the lower zone. A well tapping the lower zone at the Willow Ridge sub-division was pump tested for 72-



hours in July 1995. This well produced 36 gpm. For the June 2022 tests, the Lower Well produced 39 gpm and the Upper Well produced 34 gpm.

Historically, about seven acres of pasture were irrigated with water from the Lower Well. The Lower Well also has provided water for one residence and the Upper Well has provided water for three residences. The estimated historical pumpage at the site was about 50 acre-feet per year and the consumptive use was about 23 acre-feet per year. For the proposed project, water conservation measures would be undertaken, and the pumpage for 18 lots would be about 22 acre-feet per year. The consumptive use would be about 8 acre-feet per year. Individual septic tank systems would recharge the inside water use, and about 8 acre-feet per year of storm runoff would be recharged, to balance the consumptive use. Chemical analyses of water from the two on-site wells that were pump tested indicated that the water is of suitable quality for domestic use. Drawdowns in off-site wells would be insignificant, based on the results of the pump tests that were conducted. The proposed project would not add to the groundwater overdraft, as it would be water neutral.

#### REFERENCE

Kenneth D. Schmidt and Associates, 1995, "Groundwater Supply Report for Property near Friant Road and Willow Avenue, Fresno

County, California", prepared for David Wasemiller, Fresno, California, 18p.

# DRAFT

## Elegante Estates

Noise Study Report  
May 25, 2022

GPA566; AA3850;  
TTM 6420; VA  
4140

**Prepared by:**

VRPA Technologies, Inc.  
4630 W. Jennifer, Suite 105  
Fresno, CA 93722



# Elegante Estates Noise Study Report

## Study Team

- ✓ Georgiena Vivian, President, VRPA Technologies, Inc., [gvivian@vrpatechnologies.com](mailto:gvivian@vrpatechnologies.com), (559) 259-9257
  - ✓ Erik Ruehr, Dir. of Traffic Engineering, VRPA Technologies, Inc., [eruehr@vrpatechnologies.com](mailto:eruehr@vrpatechnologies.com), (858) 566-1766
  - ✓ Nisha Pathak, Transportation Engineer, VRPA Technologies, Inc., [jellard@vrpatechnologies.com](mailto:jellard@vrpatechnologies.com), (559) 271-1200
-

## Table of Contents

Section	Description	Page
1.0	Introduction	1
2.0	Existing Conditions	14
3.0	Short-Term Impacts	20
4.0	Long-Term Impacts	23
5.0	Impact Determination and Recommended Mitigation	24

---

# 1.0 Introduction

## 1.1 Description of the Region/Project

This Noise Study Report (NSR) has been prepared for the purpose of identifying potential noise impacts related to the proposed residential tract in Fresno County. The Project consists of the development of a 18 single family residential homes to be located south west of the Friant Road and Willow Avenue intersection (APN: 579-060-37 and 579-60-55).

The proposed Project lies within the central portion of the San Joaquin Valley in the Fresno county. The Project area is located just out northeastern portion of the city of Fresno. Figures 1 and 2 show the location of the Project along with major roadways and highways. The proposed Project is located on the Valley floor at an elevation of approximately 308 feet above sea level with the surrounding area mostly flat.

When preparing an NSR, guidelines set by the Fresno County must be followed. In analyzing noise levels, guidelines and policies in the Fresno County Noise ordinances of General Plan were utilized. Unless otherwise stated, all sound levels reported are in A-weighted decibels (dBA). A-weighting de-emphasizes the very low and very high frequencies of sound in a manner similar to the human ear. Most community noise standards use A-weighting, as it provides a high degree of correlation with human annoyance and health effects.

## 1.2 Sound and the Human Ear

Sound levels are presented on a logarithmic scale to account for the large range of acoustic pressures that the human ear is exposed to and is expressed in units of decibels (dB). A decibel is defined as the ratio between a measured value and a reference value usually corresponding to the lower threshold of human hearing defined as 20 micro pascals ( $\mu\text{Pa}$ ). Noise can generally be described as unwanted sound and has been cited as being a health problem, not just in terms of actual physiological damages such as hearing impairment, but also in terms of inhibiting general wellbeing and contributing to stress and annoyance. Long or repeated exposure to sounds at or above 85 dB can cause hearing loss. The louder the sound, the shorter the time period before hearing loss can occur. Sounds of less than 75 dB are unlikely to cause hearing loss even after long exposure.<sup>1</sup>

---

<sup>1</sup> Source: National Institute on Deafness and Other Hearing Disorders

**Elegante Estates Project**  
**Regional Location**

**Figure**  
**1**

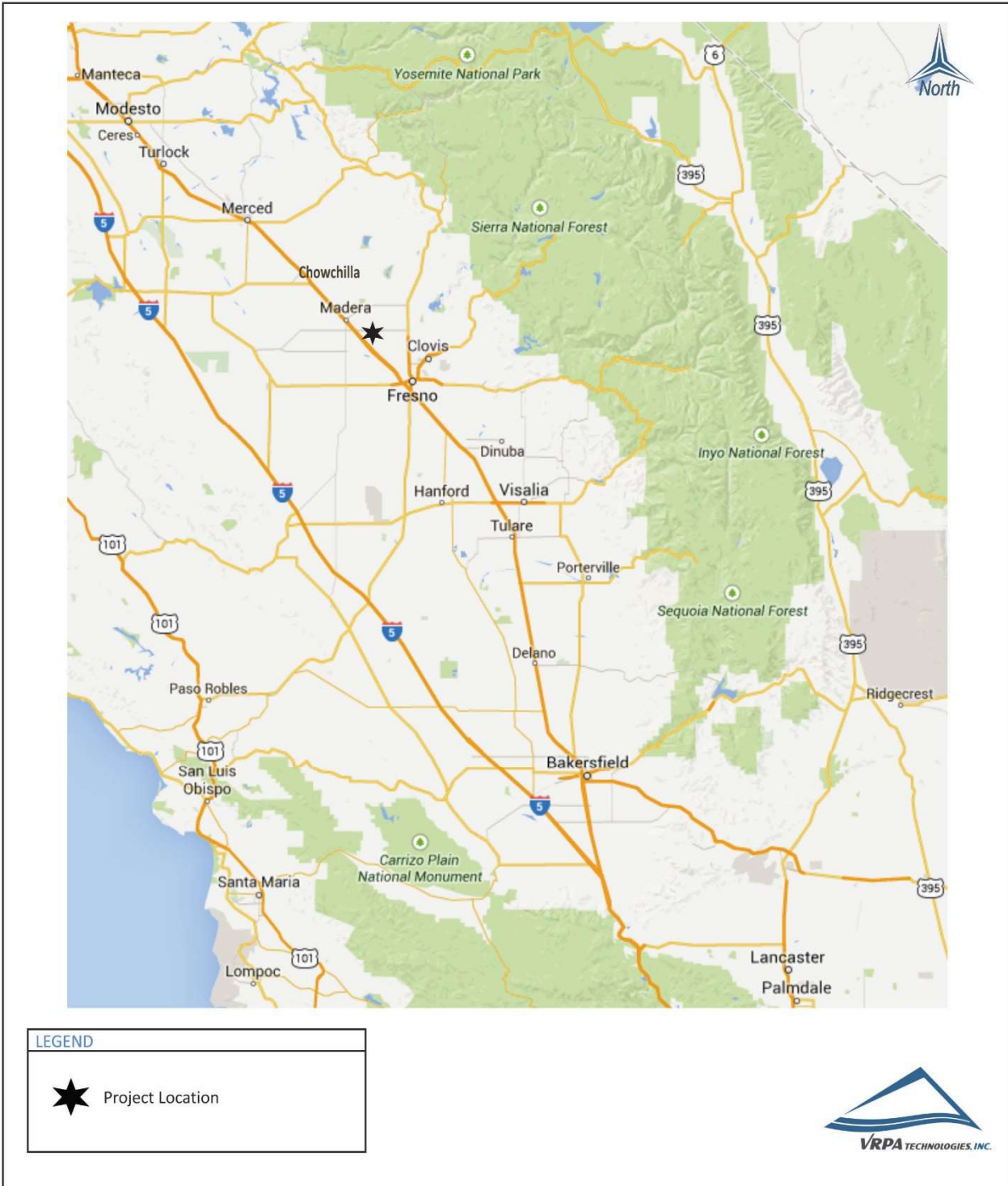

**Elegante Estates Project**  
**Project Location**

**Figure**  
**2**

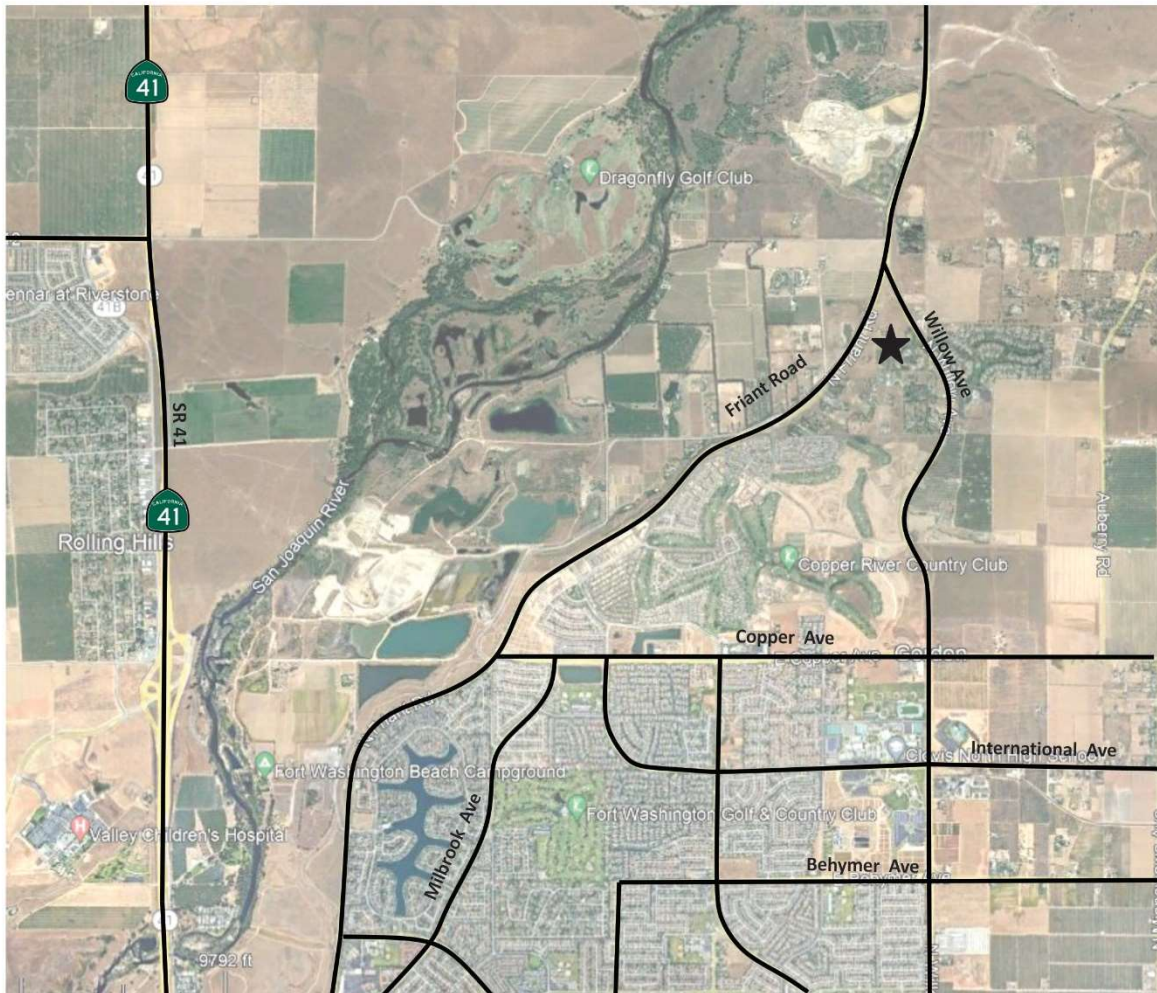

LEGEND	
	Project Location





### 1.2.1 A-Weighted Decibels

Sound pressure level alone is not a reliable indicator of loudness. The frequency, or pitch, of a sound also has a substantial effect on how humans will respond. Although the intensity (energy per unit area) of the sound is a purely physical quantity, the loudness or human response is determined by the characteristics of the human ear. Human hearing is limited not only in the range of audible frequencies but also in the way it perceives the SPL in that range. In general, the healthy human ear is most sensitive to sounds between 1,000 Hz and 5,000 Hz, and it perceives a sound within that range as being more intense than a sound of higher or lower frequency with the same magnitude. To approximate the frequency response of the human ear, a series of SPL adjustments is usually applied to the sound measured by a sound level meter. The adjustments (referred to as a weighting network) are frequency dependent. The A-scale weighting network approximates the frequency response of the average young ear when listening to most ordinary sounds. When people make judgments of the relative loudness or annoyance of a sound, their judgments correlate well with the A-scale sound levels of those sounds. Other weighting networks have been devised to address high noise levels or other special problems (e.g., B-scale, C-scale, D-scale), but these scales are rarely, if ever, used in conjunction with highway traffic noise. Noise levels for traffic noise reports are typically reported in terms of A-weighted dBAs. In environmental noise studies, A-weighted SPLs are commonly referred to as noise levels.

Unfortunately, there is no completely satisfactory way to measure the subjective effects of noise, or of the corresponding reactions of annoyance and dissatisfaction. This is primarily because of the wide variation in individual thresholds of annoyance, and habituation to noise over differing individual experiences with noise. Thus, an important way of determining a person's subjective reaction to a new noise is the comparison of it to the existing environment, referred to as the "ambient" environment. In general, the more a new noise exceeds the previously existing ambient noise level, the less acceptable the new noise will be judged by the hearers. Regarding increases in A-weighted noise level, knowledge of the following relationships will be helpful in understanding this report:

1. Except in carefully controlled laboratory experiments, a change of 1 dB cannot be perceived by humans.
2. Outside of the laboratory, a 3 dB change is considered a just-perceivable difference.
3. A change in level of at least 5 dB is required before any noticeable change in community response would be expected.
4. A 10 dB change is subjectively heard as approximately a doubling in loudness.

### 1.2.2 Sound Pressure Levels and Decibels

Because of the ability of the human ear to detect a wide range of sound pressure fluctuations, sound pressure levels are expressed in logarithmic units called decibels. The sound pressure level in decibels is calculated by taking the log of the ratio between the actual sound pressure and the reference sound pressure squared. The reference sound pressure is considered the absolute

hearing threshold. In addition, because the human ear is not equally sensitive to all sound frequencies, a specific frequency-dependent rating scale was devised to relate noise to human sensitivity. A dBA scale performs this compensation by discriminating against frequencies in a manner approximating the sensitivity of the human ear. The basis for comparison is the faintest sound audible to the average ear at the frequency of maximum sensitivity. This dBA scale has been chosen by most authorities for purposes of environmental noise regulation. Typical indoor and outdoor noise levels are presented in Figure 3 (Common Environmental Sound Levels).

### 1.2.3 *Sound, Noise, and Acoustics*

Sound is a disturbance created by a moving or vibrating source in a gaseous or liquid medium or the elastic stage of a solid and is capable of being detected by the hearing organs. Sound may be thought of as the mechanical energy of a vibrating object transmitted by pressure waves through a medium to a hearing organ, such as a human ear. For traffic sound, the medium of concern is air. Noise is defined as sound that is loud, unpleasant, unexpected, or undesired. Sound is actually a process that consists of three components: the sound source, the sound path, and the sound receiver. All three components must be present for sound to exist. Without a source to produce sound, there is no sound. Likewise, without a medium to transmit sound pressure waves, there is also no sound. Finally, sound must be received; a hearing organ, sensor, or object must be present to perceive, register, or be affected by sound or noise. In most situations, there are many different sound sources, paths, and receivers rather than just one of each. Acoustics is the field of science that deals with the production, propagation, reception, effects, and control of sound.

### 1.2.4 *Frequency and Hertz*

A continuous sound can be described by its frequency (pitch) and its amplitude (loudness). Frequency relates to the number of pressure oscillations per second. Low-frequency sounds are low in pitch, like the low notes on a piano, whereas high-frequency sounds are high in pitch, like the high notes on a piano. Frequency is expressed in terms of oscillations, or cycles, per second. Cycles per second are commonly referred to as Hertz (Hz). A frequency of 250 cycles per second is referred to as 250 Hz. High frequencies are sometimes more conveniently expressed in units of kilo-Hertz (kHz), or thousands of Hertz. The extreme range of frequencies that can be heard by the healthiest human ear spans from 16–20 Hz on the low end to about 20,000 Hz (or 20 kHz) on the high end.

**Elegante Estates Project**  
**Common Environmental Sound Levels**

**Figure**  
**3**

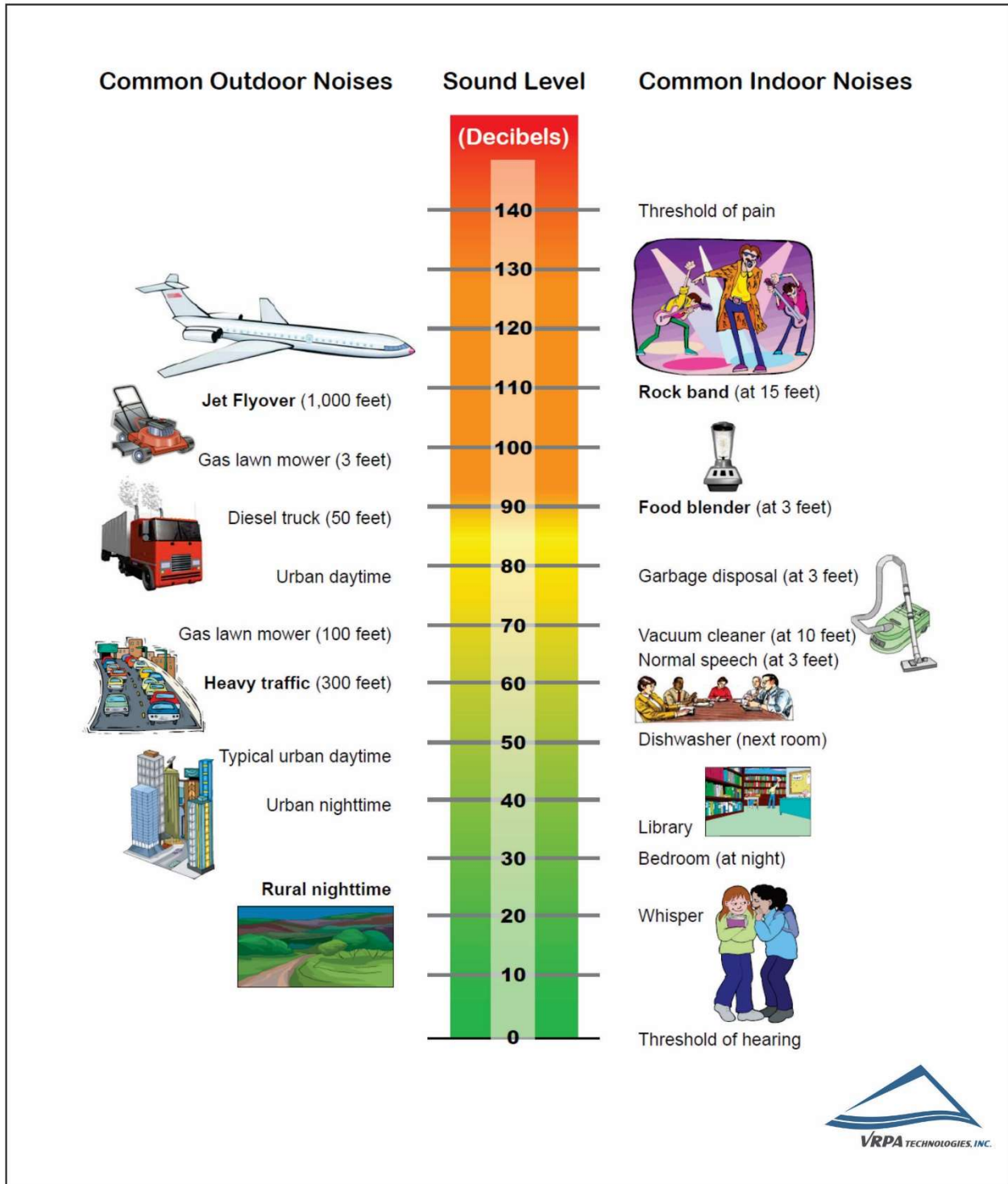

### 1.2.5 Addition of Decibels

Because decibels are logarithmic units, sound pressure levels cannot be added or subtracted by ordinary arithmetic means. For example, if one automobile produces an SPL of 70 dBA as it passes an observer, two cars passing simultaneously would not produce 140 dBA; they would, in fact, combine to produce 73 dBA. When two sounds of equal SPL are combined, they will produce a combined SPL 3 dBA greater than the original individual SPL. In other words, sound energy must be doubled to produce a 3 dBA increase. If two sound levels differ by 10 dBA or more, the combined SPL is equal to the higher SPL; in other words, the lower sound level does not increase the higher sound level.

## 1.3 Characteristics of Sound Propagation and Attenuation

Noise can be generated by a number of sources, including mobile sources such as automobiles, trucks, and airplanes, and stationary sources such as construction sites, machinery, and industrial operations.

Noise generated by mobile sources typically attenuates (is reduced) at a rate between 3.0 and 4.5 dBA per doubling of distance. The rate depends on the ground surface and the number or type of objects between the noise source and the receiver. Hard and flat surfaces, such as concrete or asphalt, have an attenuation rate of 3.0 dBA per doubling of distance. Soft surfaces, such as uneven or vegetated terrain, have an attenuation rate of about 4.5 dBA per doubling of distance.

Noise generated by stationary sources typically attenuates at a rate between 6.0 and about 7.5 dBA per doubling of distance. Sound levels can be reduced by placing barriers between the noise source and the receiver (commonly called the “receptor”). In general, barriers contribute to decreasing noise levels only when the structure breaks the “line of sight” between the source and the receiver. Buildings, concrete walls, and berms can all act as effective noise barriers. Wooden fences or broad areas of dense foliage can also reduce noise but are less effective than solid barriers.

### 1.3.1 Noise Descriptors

Noise in the daily environment fluctuates over time. Some of the fluctuations are minor; some are substantial. Some noise levels occur in regular patterns; others are random. Some noise levels fluctuate rapidly, others slowly. Some noise levels vary widely; others are relatively constant. Various noise descriptors have been developed to describe time-varying noise levels. The following is a list of the noise descriptors most commonly used in traffic noise analysis:

1. **Equivalent Sound Level (Leq)** - Leq represents an average of the sound energy occurring over a specified period. Leq is, in effect, the steady-state sound level that, in a stated period, would contain the same acoustical energy as the time-varying sound that actually occurs during the

same period. The one-hour A-weighted equivalent sound level,  $Leq(h)$ , is the energy average of the A-weighted sound levels occurring during a one-hour period and is the basis for the Noise Abatement Criteria (NAC) used by the California Department of Transportation (Caltrans) and the Federal Highway Administration (FHWA).

2. **Percentile-Exceeded Sound Level ( $L_x$ )** -  $L_x$  represents the sound level exceeded for a given percentage of a specified period. For example,  $L_{10}$  is the sound level exceeded 10 percent of the time, and  $L_{90}$  is the sound level exceeded 90 percent of the time.
3. **Maximum Sound Level ( $L_{max}$ )** -  $L_{max}$  is the highest instantaneous sound level measured during a specified period.

### 1.3.2 Sound Propagation

When sound propagates over a distance, it changes in both level and frequency content. The manner in which noise reduces with distance depends on the following factors:

1. **Geometric Spreading** - Sound from a small, localized source (i.e., a point source) radiates uniformly outward as it travels away from the source in a spherical pattern. The sound level attenuates (or drops off) at a rate of six dBA for each doubling of distance. Highway noise is not a single, stationary point source of sound. The movement of the vehicles on a highway makes the source of the sound appear to emanate from a line (i.e., a line source) rather than a point. This line source results in cylindrical spreading rather than the spherical spreading that results from a point source. The change in sound level from a line source is 3 dBA per doubling of distance.
2. **Ground Absorption** - Most often, the noise path between the highway and the observer is very close to the ground. Noise attenuation from ground absorption and reflective wave canceling adds to the attenuation associated with geometric spreading. Traditionally, the excess attenuation has also been expressed in terms of attenuation per doubling of distance. This approximation is done for simplification only; for distances of less than 60 m (200 ft), prediction results based on this scheme are sufficiently accurate. For acoustically hard sites (i.e., those sites with a reflective surface, such as a parking lot or a smooth body of water, between the source and the receiver), no excess ground attenuation is assumed. For acoustically absorptive or soft sites (i.e., those sites with an absorptive ground surface, such as soft dirt, grass, or scattered bushes and trees, between the source and the receiver), an excess ground attenuation value of 1.5 dBA per doubling of distance is normally assumed. When added to the geometric spreading, the excess ground attenuation results in an overall drop-off rate of 4.5 dBA per doubling of distance for a line source and 7.5 dBA per doubling of distance for a point source.
3. **Atmospheric Effects** - Research by Caltrans and others has shown that atmospheric conditions can have a significant effect on noise levels within 60 m (200 ft) of a highway. Wind has been shown to be the most important meteorological factor within approximately 150 m (500 ft) of the source, whereas vertical air temperature gradients are more important for greater distances. Other factors such as air temperature, humidity, and turbulence also have significant effects. Receivers located downwind from a source can be exposed to increased

noise levels relative to calm conditions, whereas locations upwind can have lower noise levels. Increased sound levels can also occur as a result of temperature inversion conditions (i.e., increasing temperature with elevation).

4. Shielding by Natural and Human-Made Features - A large object or barrier in the path between a noise source and a receiver can substantially attenuate noise levels at the receiver. The amount of attenuation provided by this shielding depends on the size of the object and the frequency content of the noise source. Natural terrain features (e.g., hills and dense woods) and human-made features (e.g., buildings and walls) can substantially reduce noise levels. Walls are often constructed between a source and a receiver specifically to reduce noise. A barrier that breaks the line of sight between a source and a receiver will typically result in at least 5 dBA of noise reduction.

## 1.4 Ground-borne Vibration

Annoyance to humans and damage to buildings are the two ground-borne vibration impacts of general concern. The two measurements corresponding to human annoyance and building damage for evaluating ground-borne vibration are peak particle velocity (PPV) and root-mean square (RMS) velocity. PPV is the maximum instantaneous positive or negative peak of the vibration signal, measured as a distance per time (such as millimeters or inches per second). This measurement has been used historically to evaluate shock-wave type vibrations from actions like blasting, pile driving, and mining activities, and their relationship to building damage. RMS is an average, or smoothed, vibration amplitude, commonly measured over 1-second intervals. It is expressed on a log scale in decibels (VdB) referenced to  $0.000001 \times 10^{-6}$  inch per second and is not to be confused with noise decibels. It is more suitable for addressing human annoyance and characterizing background vibration conditions because it better represents the response time of humans to ground vibration signals.

## 1.5 Methodology

When preparing an NSR, guidelines set by affected agencies must be followed. Acoustical terminology used for this NSR is documented in Appendix A. In analyzing traffic noise levels, the FHWA Highway Traffic Noise Prediction methodology must be applied. Safety concerns must also be analyzed to determine the need for appropriate mitigation resulting from increased noise due to increased traffic and other evaluations such as the need for noise barriers and other noise abatement improvements. Stationary noise levels were evaluated using Section 2.1.4 of the California Department of Transportation's (Caltrans) Technical Noise Supplement which evaluates the decrease in noise as distance from the noise source increases. Unless otherwise stated, all sound levels reported are in A-weighted decibels (dBA). A-weighting de-emphasizes the very low and very high frequencies of sound in a manner similar to the human ear. Most community noise standards use A-weighting, as it provides a high degree of correlation with human annoyance and health effects.



### 1.5.1 California Environmental Quality Act (CEQA)

CEQA requires environmental impact reports to evaluate whether and to what extent a proposed project may result in significant effects on the environment. If a project is determined to have a significant noise impact under CEQA, then CEQA dictates that mitigation measures must be incorporated into the project unless such measures are also evaluated and determined to not be feasible. An EIR is also required to evaluate a reasonable range of alternatives to the proposed Project that could feasibly attain most of the basic objectives of the project but would avoid or substantially lessen any of the significant effects of the project. An EIR must also evaluate a “No Project” Alternative. CEQA Guidelines Appendix G suggests the following as potential thresholds for determining whether a project will result in significant impacts on the environment:

- a) Generation of a substantial temporary or permanent increase in ambient noise levels in the vicinity of the project in excess of standards established in the local general plan or noise ordinance, or applicable standards of other agencies?
- b) Generation of excessive groundborne vibration or groundborne noise levels?
- c) For a project located within the vicinity of a private airstrip or an airport land use plan or, where such a plan has not been adopted, within two miles of a public airport or public use airport, would the project expose people residing or working in the project area to excessive noise levels?

### 1.5.2 Fresno County

The Noise Chapter of the Fresno General Plan adopted October 3, 2000, serves as the primary policy statement for areas within Fresno County to maintain and improve the noise environment in the City. This Chapter establishes Goals and Objectives relative to planning for the noise standards environment throughout areas and is consistent with other General Plan Elements. Additionally, the Noise Chapter establishes policies to protect noise sensitive uses from excessive noise either through noise reducing project design or by allowing noise sensitive land uses to locate only in areas with ambient noise levels below specific thresholds.

Fresno County requires the noise sensitive land uses like residential neighborhoods, schools, and hospital to be located in the area where existing or projected noise levels are acceptable. Future noise/land use incompatibilities can be avoided or reduced with implementation of Fresno County noise mitigation measures standards. The County realizes that it may not always be possible to avoid constructing noise-sensitive developments in existing noisy areas and therefore provides noise reduction strategies to be implemented in situations with potential noise/land use conflicts. It should be noted that the County does not have specific zoning or general plan requirements related to vibration.

Table 1 shows the Fresno County maximum allowable noise exposure from Transportation Noise Sources. Table 2 shows the City of Fresno maximum allowable noise exposure from Stationary

Noise Sources (non-transportation noise). The information presented in Table 1 and Table 2 comes from the Noise Chapter of the Fresno County General Plan.

**Table 1**  
**Transportation (Non-Aircraft) Noise Sources**

Noise-Sensitive Land Use <sup>1</sup>	Outdoor Activity Areas <sup>2</sup>	Interior Spaces	
	Ldn/CNEL, dB	Ldn/CNEL, dB	L <sub>eq</sub> , dB <sup>2</sup>
Residential	65	45	--
Transient lodging	65	45	--
Hospitals, Nursing Homes	65	45	--
Theaters, Auditoriums, Music Halls	--	--	35
Churches, Meeting Halls	65	--	45
Office Buildings	--	--	45
Schools, Libraries, Museums	--	--	45

Notes:

(1) Where the location of outdoor activity area is unknown or is not applicable, the exterior noise level standard shall be applied to the property line of the receiving land use.

(2) As determined for a typical worst-case hour during periods of use.

-- = not applicable

Ldn = Day-Night Average Level

CNEL = Community Noise Equivalent Level

dB = Decibels

L<sub>eq</sub> = Noise Equivalent Level



**Table 2**  
**Stationary Noise Sources**

	Daytime (7:00 a.m. - 10:00 p.m.)	Nighttime (10:00 p.m. - 7:00 a.m.)
Hourly Equivalent Sound Level ( $L_{eq}$ ), dBA	50	45
Maximum Sound Level ( $L_{max}$ ), dBA	70	60

Notes:

(1) The Department of Development and Resource Management Director, on a case-by-case basis, may designate land uses other than those shown in this table to be noise-sensitive, and may require appropriate noise mitigation measures.

(2) As determined at outdoor activity areas. Where the location of outdoor activity areas is unknown or not applicable, the noise exposure standards shall be applied at the property line of the receiving land use. When ambient noise levels exceed or equal the levels of this table, mitigation shall only be required to limit noise to the ambient plus five dB.

$L_{eq}$  = Noise Equivalent Level

$L_{max}$  = Maximum noise level recorded during a noise event

### 1.5.3 Study Methods and Procedures

#### Site Selection

The Project site was assessed through land use maps, aerial photography, and site inspection to determine the most effective placement of noise monitoring devices. Developed and undeveloped land uses in the project vicinity were identified through land use maps, aerial photography, and site inspection. Within each land use category, sensitive receptors were then identified. Land uses in the project vicinity include residential and agricultural uses however, the project proximity to Friant Road presents the possibility of significant noise levels at the Project site. The generalized land use data and location of sensitive receptors were the basis for the selection of the noise monitoring and analysis sites. Measurements were taken on all sides of the Project site.

#### Noise Level Measurement Program

Existing noise levels in the project vicinity were sampled during the PM peak hour because traffic counts conducted in the study area show a greater volume of traffic in the PM peak hour than the AM peak hour. All measurements were made using an Extech Type 2 sound level meter datalogger.

The following measurement procedure was utilized:

1. Calibrate sound level meter.

2. Set up sound level meter at a height of 1.5 m (5 ft).
3. Commence noise monitoring.
4. Collect site-specific data such as date, time, direction of traffic, and distance from sound level meter to the center of the roadway.
5. Stop measurement after 15 minutes.
6. Proceed to next monitoring site and repeat.

## 2.0 Existing Conditions

Existing noise levels in the County are principally generated by transportation noise sources. Vehicular traffic noise is the dominant source in most areas, but aircraft and rail activity are also significant sources of environmental noise in the local areas surrounding these operations. Noise is generated by either mobile or stationary sources.

- ✓ Mobile source noise is typically associated with transportation, such as cars, trains, and aircraft. The most significant sources of mobile noise in the County are SR-41, SR-99, SR-168, SR-180 and other major arterial roadways, and aircraft operations at the Fresno Yosemite International Airport.
- ✓ Stationary noise is that generated by any 'fixed' noise source. Examples of stationary sources include outdoor machinery (i.e. such as heating/air conditioning systems and power generators), farming activities, high voltage power lines, and industrial areas within the County. Noise generated from construction sites also falls into the category of stationary sources.

### 2.1 Traffic Noise

Highway and roadway traffic noise levels are generally dependent upon three primary factors, which include the traffic volume, the traffic speed, and the percent of heavy vehicles on the roadway. Traffic generated noise is the result of vehicle engines, exhaust, tires, and wind generated by taller vehicles. Vehicles with defective mufflers or faulty equipment have the propensity to increase traffic noise. Traffic noise levels are reduced by distance, terrain, vegetation, and natural/manmade obstacles between a noise receptor and the highway/roadway.

To assess existing noise conditions, VRPA Technologies staff conducted noise level measurements at three (3) locations (called receivers) around the perimeter of the Project study area and tabulated the results. The weather during the time of noise measurements consisted of sunshine and wind speeds of less than 5 mph. The purpose of the measurements was to determine baseline existing noise levels in the Project area and to calibrate the FHWA Traffic Noise model, which will be used to then predict and assess Project impacts.

Existing noise levels in the project vicinity were sampled during both AM and PM peak hour, and the greater one were selected for the purpose of the study because traffic counts has not been conducted yet. The receiver locations are shown in Figure 4. It should be noted that the receiver distance from the roadway centerline in Figure 4 represents the location of sound level meter while collecting ambient noise levels in the study area.

**Elegante Estates Project**  
**Noise Receiver Location**

**Figure**  
**4**

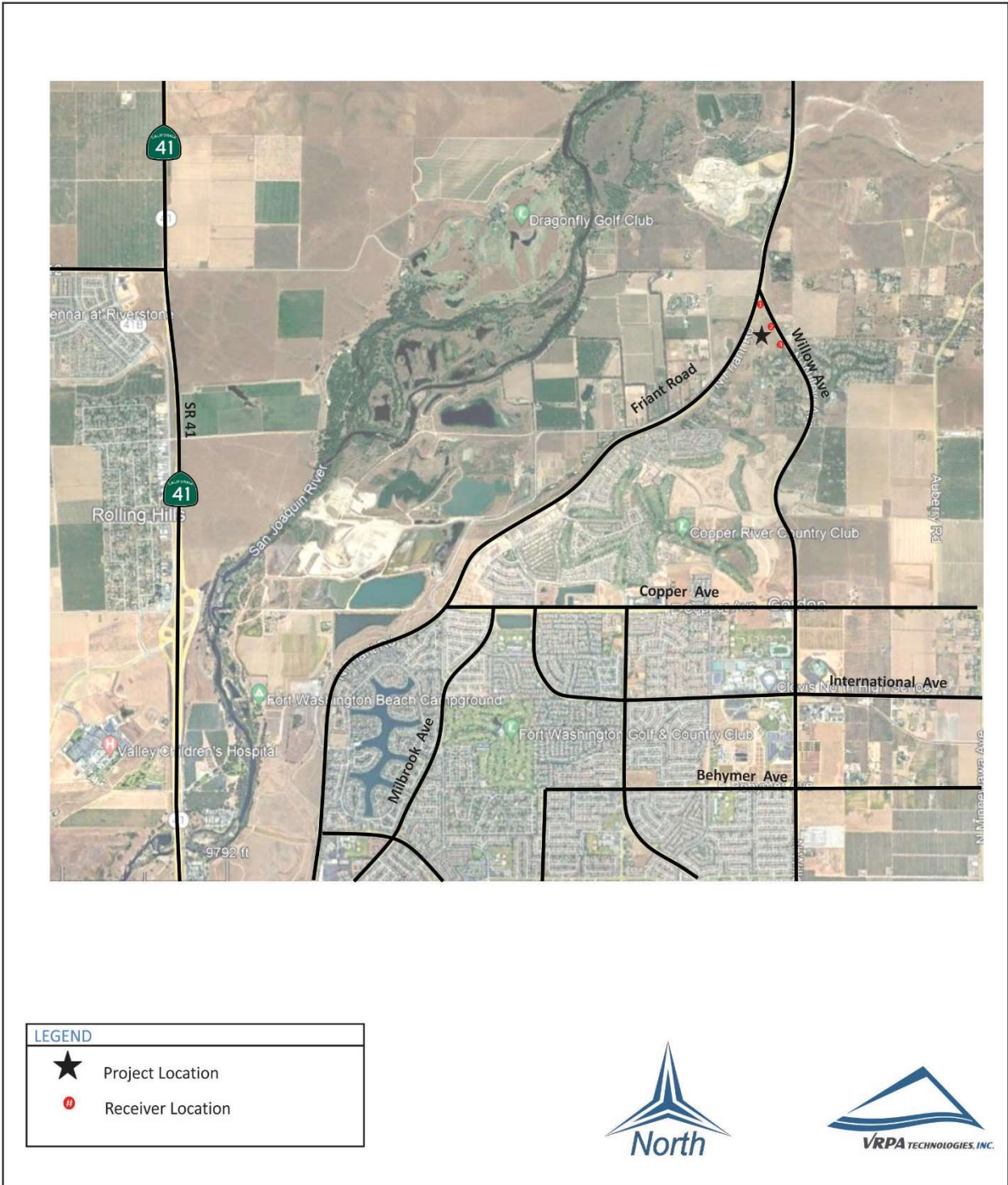

Table 3 characterizes the results of the existing noise conditions at the three (3) receivers evaluated in the study area. Traffic noise exposure is mainly a function of the number of vehicles on a given roadway per day, the speed of those vehicles, the percentage of medium and heavy trucks in the traffic volume, and the receiver’s proximity to the roadway. Every vehicle passage on every roadway in the City radiates noise.

Existing high noise levels along major streets and highways are generally caused by traffic and congestion. Potential impacts along these facilities are generally classified as follows:

- ✓ Low - Ldn 59 dB or below
- ✓ Moderate - Ldn 60 dB to 65 dB
- ✓ High - Ldn 66 dB or greater

The potential for adverse noise impacts is generally moderate to high along most segments of State highways and is generally low to moderate along most segments of City streets and highways.

## 2.2 Railroad Noise

The San Joaquin Valley Railroad (SJVRR), The Burlington Northern Santa Fe Railroad, and the Union Pacific Railroad operate in the Fresno County. Passenger and commercial rail service in Fresno County is provided on these rail lines. Railroad noise will not impact the Project study area since the nearest rail line is over 2 miles away.

**Table 3**  
Existing Noise Levels

Receiver ID No.	Location	Distance from Noise Source- Roadway Centerline (feet)	Existing Noise Level Leq(h) dBA
1	Vacant Lot Project Site (Friant and Willow intersection)	100	29.0
2	Vacant Lot (project Site along Willow Avenue)	15	23.0
3	Eastern limit of project site( Adjacent to existing residential units)	20	28.0

Source: VRPA Technologies, 2022

## 2.3 Airport Noise

The Fresno Yosemite International Airport and Sierra Sky Park Airport are located nearly 9 miles south and southwest of the Project, respectively. The Fresno Yosemite International Airport is the largest and busiest airport in the San Joaquin Valley. During 2016, 1.44 million passengers flew in and out of the Fresno Yosemite International Airport. Total operations included approximately 98,000 in 2016 according to the Fresno Airports Master Plan. This includes air carrier, air taxi and commuter, general aviation, and military operations. The Sierra Sky Park Airport is a small public airport that averaged 39 aircraft operations per day in 2016. The Airport Influence Area (AIA) and Safety Zones and noise exposure contours for the Fresno Yosemite International Airport and Sierra Sky Park Airport do not encompass the Project site. Therefore, noise generated from the airports will not impact the Project study area.

## 2.4 Roadway Network

Functional classification is the process by which streets and highways are grouped into classes, or systems, according to the type of service they are intended to provide. Fundamental to this process is the recognition that individual streets and highways do not serve travel independently in any major way. Rather, most travel involves movement through a network of roads.

The current hierarchical system of roadways consists of the following six (6) basic classifications:

**State Route 41** – currently exists as a six-lane facility with a posted speed limit of 65 mph in the study area. According to the California Department of Transportation’s website, the average annual daily traffic (AADT) along SR 41 in this area consisted of approximately 109,000 trips in 2017.

- ✓ **Expressways** – are high-speed, two- to six-lane divided roadways, primarily servicing through and cross-town traffic, with no direct access to abutting property and at-grade intersections located at approximately half-mile intervals. Expressways do not presently exist within the study area.
- ✓ **Super Arterials** – Four- to six-lane divided roadways with a primary purpose of moving traffic to and from major traffic generators and between community plan areas. Access will typically be limited to right-turn entrance and exit vehicular movements. Super Arterials presently exist within the study area.

**Friant Road** – is a divided 4-lane roadway with a posted speed limit of 60 mph.

- ✓ **Arterial** – Four- to six-lane divided roadways, with somewhat limited access to abutting properties, and with the primary purpose of moving traffic within and between community plan areas and to and from freeways and expressways.

- ✓ **Collectors** – Two to four-lane undivided roadways, with the primary function of connecting local streets and arterials and neighborhood traffic generators and providing access to abutting properties.
  - **Willow Avenue** – is a divided -lane roadway with a posted speed limit of 45 mph. Class II bike lanes are present along the roadway.
- ✓ **Local Streets** – Two- to three-lane public or private roadways designed to provide direct access to properties while discouraging through traffic between major streets. They are intended to carry low volumes of traffic and support unrestricted on-street parking.

## 2.5 Stationary Noise

There are a wide variety of industrial and other non-transportation noise sources throughout the Fresno County, including heavy industrial or manufacturing operations, food packaging and processing facilities, lumber mills, and car washes to name a few. The change in noise level due to distance for point sources is determined by the following formula, which comes from the California Department of Transportation’s (Caltrans) Technical Noise Supplement to the Traffic Noise Analysis Protocol:

$$dBA_2 = dBA_1 + 10\log_{10}[(D_1/D_2)]^2 = dBA_1 + 20\log_{10}(D_1/D_2)$$

Where:

$dBA_1$  = noise level at distance  $D_1$

$dBA_2$  = noise level at distance  $D_2$

Stationary noise impacts to the Project will be developed considering the formula above and the closest distance between the Project site and stationary noise sources in the surrounding area.

## 2.6 Ground-borne Vibration

Ambient vibration levels in residential areas are typically 50 VdB, which is well below human perception. The operation of heating/air conditioning systems and slamming of doors produce typical indoor vibrations that are noticeable to humans. The most common exterior sources of ground vibration that can be noticeable to humans inside residences include construction activities, train operations, and street traffic. Table 4 provides some common sources of ground vibration and the relationship to human perception. This information comes from the Federal Transit Administration’s “Basic Ground-Bourne Vibration Concepts.”



**Table 4**  
**Typical Levels of Ground-Borne Vibration**

Human/Structural Response	Velocity Level, VdB	Typical Events (50 ft. Setback)
Threshold, minor cosmetic damage fragile buildings	100	Blasting from construction projects Bulldozers and other heavy tracked construction equipment
Difficulty with tasks such as reading a video or computer screen	90	Commuter rail, upper range
Residential annoyance, infrequent events (e.g commuter rail)	80	Rapid transit, upper range Commuter rail, typical
Residential annoyance, infrequent events (e.g rapid transit)	70	Bus or truck over bump Rapid transit, typical
Limit for vibration sensitive equipment. Approx. threshold for human perception of vibration	60	Bus or truck, typical
	50	Typical background vibration



## 3.0 Short-Term Impacts

### 3.1 Construction Noise Impacts

The Project has the potential to result in short-term noise impacts to surrounding land uses due to construction activity noise (collectively referred to hereafter as just “construction” noise). Construction noise represents a short-term impact on ambient noise levels and includes activities such as site preparation, grading, and other construction-related activities. Noise generated from the transport of workers and the movement of materials to and from the construction site and the physical activities associated with any construction-related activities could potentially impact neighboring sensitive land uses. Although most of the types of exterior construction activities associated with the Project will not generate continually high noise levels, occasional single-event disturbances from grading and construction activities are possible.

Table 5 depicts typical construction equipment noise levels, based upon a distance of 50 feet between the noise source and the noise receptor. Noise emitted by construction equipment is controlled by the Environmental Protection Agency's (EPA's) Noise Control Program (Part 204 of Title 40, Code of Federal Regulations).

During construction of the Project, noise from construction activities will add to the noise environment in the immediate area. Activities involved in building construction would generate maximum noise levels, as indicated in Table 5, ranging from 77 to 85 dBA at a distance of 50 feet. Construction activities will be temporary in nature and are expected to occur during normal daytime working hours. Construction noise impacts could result in annoyance or sleep disruption for nearby residences if nighttime operations occurred, or if unusually noisy equipment was used. It is not anticipated that any portion of the construction phase will take place during nighttime hours. Based on information provided in Table 5 and the noise attenuation formula provided in Section 2.5, the nearest single-family residence to the east of the Project site (170 feet) may be subject to short-term noise reaching 66 to 74 dBA L<sub>max</sub> generated by construction activities in the absence of noise barrier. Considering the maximum sound level of 70 dBA L<sub>max</sub> from the Fresno County Stationary Noise Sources (Table 2), construction of the Project will not impact neighboring residences. Construction activities associated with the Project will be subject to Chapter 10 of the Fresno County Municipal Code.

**Table 5**  
**Construction Equipment Noise**

TYPE OF EQUIPMENT	Sound Levles Measured (dBA of 50 feet)
Rock Drills	85
Jack Hammers	85
Pneumatic Tools	85
Pumps	77
Dozers	85
Tractor	84
Front-End Loaders	80
Hydraulic Backhoe	80
Hydraulic Excavators	85
Graders	85
Air Compressors	80
Trucks	84

Source: Noise Control for Buildings and Manufacturing Plants (Bolt, Beranek and Newman, 1987).

### 3.2 Ground-borne Vibration

Construction activity can result in ground vibration, depending upon the types of equipment used. Operation of construction equipment causes ground vibrations, which spread through the ground and diminish in strength with distance from the source generating the vibration. Building structures that are founded on the soil in the vicinity of the construction site respond to these vibrations, with varied results. Ground vibrations as a result of construction activities very rarely reach vibration levels that will damage structures but can cause low rumbling sounds and detectable vibrations for buildings very close to the site.

Vibration levels from various types of construction equipment are shown in Table 6. The primary concern with construction vibration is building damage. Therefore, construction vibration is generally assessed in terms of peak particle velocity (PPV). It should be noted that there is a considerable variation in reported ground vibration levels from construction activities. The data provides a reasonable estimate for a wide range of soil conditions.

Despite the perceptibility threshold of about 65 VdB, human reaction to vibration is not significant unless the vibration exceeds 75 VdB according to the United States Department of Transportation. In order to estimate the impact of vibrations from construction activities at

distances of 100 feet, 150 feet, and 200 feet, the following formula was applied:

$$Lv(D) = Lv(25\text{ ft}) - 20 \log (D/25)$$

Using the highest vibration level shown in Table 6 (Lv 87) and the formula shown above, the anticipated vibration levels at 100 feet, 150 feet, and 200 feet are 75, 71, and 69 VdB, respectively.

Construction activities associated with the Project would likely require the use of various types of equipment including bulldozers and dump trucks. Based on the vibration levels provided in Table 6, ground vibration generated by common construction equipment would be 75 VdB or less at a distance of 100 feet or more. The Project site is relatively flat and wouldn't generally require the use of a large bulldozer or caisson drilling. Considering the planned location of the Elegante estates single detached homes, it is not anticipated that construction of the Project would impact adjacent. As a result, the anticipated vibration levels at the nearest off-site structures is 70 VdB that is less than 75 VdB.

**Table 6**  
**Vibration Source Levels for Construction Equipment**

Equipment	PPV at 25 ft (in/sec)	Approximate $L_v^*$ at 25 ft
Large bulldozer	0.089	87
Caisson drilling	0.089	87
Loaded trucks	0.076	86
Jackhammer	0.035	79
Small bulldozer	0.003	58

\*RMS velocity in decibels (VdB) re 1 minch/second

## 4.0 Long-Term Impacts

### 4.1 Traffic Noise Impacts

This section provides an assessment of the anticipated noise conditions in the future as it relates to the Project and the impact of increased traffic noise generated by the Project on the surrounding land uses within the study area. The Fresno County maximum allowable noise exposure from Transportation Sources is reflected in Table 2. The hourly and maximum sound level allowed at sensitive receivers in residential property during in the outdoor and indoor area is 65 dBA and 45 dBA, respectively. Referencing Table 1, the Fresno County Transportation Noise Source criteria shows that mitigation must be considered when the exterior noise exposure level of 65 Ldn/CNEL for residential uses has been exceeded. Levels reported in this section are in terms of A-weighted levels. It should be noted that the Ldn is estimated to be within +/- 2 dBA of the peak hour  $L_{eq}$  under normal traffic conditions based upon Caltrans' Traffic Analysis Noise Protocol.

The expected trip generation for the project was determined by the Institute of Transportation Engineers Trip Generation Manual, 10<sup>th</sup> Edition. A total of 215 daily trips, 18 AM Peak hour trips and 20 PM peak hour trips are expected to be generated. The noise impacts from the development of the Project was analyzed considering existing Conditions. Traffic volumes associated with the Project in addition to existing traffic along Friant Road and Willow Avenue were very small. Future development within the planning area will not result in high traffic volumes. As a result, the Project will not create a significant impact at sensitive receptors in the study area. It should be noted that the noise levels will be account for noise attenuation caused by buildings or tree/shrubs that break the line of sight from the sound source to the receiver. A decibel reduction of 3 to 5 dBA is plausible when buildings or trees/shrubs break the line of sight according to FHWA.

### 4.2 Stationary Noise Impacts

The Fresno County maximum allowable noise exposure from Stationary Noise Sources is reflected in Table 2. The hourly and maximum sound level allowed at sensitive receivers (residential, transient lodging) during daytime (7:00am to 10:00pm) hours is 50 dBA and 70 dBA, respectively. This section evaluates the noise generated by on-site sources. The Project does not include an outdoor activity area that could be impacted by near-by stationary noise sources.

## 5.0 Impact Determinations and Recommended Mitigation

In accordance with CEQA, the effects of a project are evaluated to determine if they will result in significant adverse impacts on the environment. The criteria used to determine the significance of a noise impact are based on the following thresholds of significance, which come from Appendix G of the CEQA Guidelines. Accordingly, noise impacts resulting from the Project are considered significant if the Project would result in:

- a) Generation of a substantial temporary or permanent increase in ambient noise levels in the vicinity of the project in excess of standards established in the local general plan or noise ordinance, or applicable standards of other agencies?
- b) Generation of excessive ground borne vibration or ground borne noise levels?
- c) For a project located within the vicinity of a private airstrip or an airport land use plan or, where such a plan has not been adopted, within two miles of a public airport or public use airport, would the project expose people residing or working in the project area to excessive noise levels?

Each of these thresholds are evaluated individually below to determine whether the Project will cause a significant effect on the environment. Where impacts are found to be significant, mitigation measures are recommended that would avoid or reduce the impact to less than significant.

### 5.1 Generation of a substantial temporary or permanent increase in ambient noise levels in the vicinity of the project in excess of standards established in the local general plan or noise ordinance, or applicable standards of other agencies?

#### 5.1.1 Short-Term Impacts

Implementation of the Project has the potential to result in short-term construction noise impacts to surrounding land uses due to construction activities. Although most of the types of exterior construction activities associated with the Project will not generate continually high noise levels, occasional single-event disturbances from grading and construction activities are possible. Table 5 depicts typical construction equipment noise. Construction equipment noise is controlled by the EPA's Noise Control Program (Part 204 of Title 40, Code of Federal Regulations).

During construction of the Project, noise from construction activities will add to the noise environment in the immediate area. Activities involved in building construction would generate maximum noise levels, as indicated in Table 5, ranging from 77 to 85 dBA at a distance of 50 feet. Construction activities will be temporary in nature and are expected to occur during normal daytime working hours. Construction noise impacts could result in annoyance or sleep disruption for nearby residences if nighttime operations occurred, or if unusually noisy equipment was used. It is not anticipated that any portion of the construction phase will take place during nighttime hours. Based on information provided in Table 5 and the noise attenuation formula provided in Section 2.5, the nearest single-family residence to the east of the Project site (170 feet) may be subject to short-term noise reaching 66 to 74 dBA Lmax generated by construction activities. Considering the maximum sound level of 70 dBA Lmax from the Fresno County Stationary Noise Sources (Table 2), construction of the Project will not impact neighboring residences. Construction activities associated with the Project will be subject to Chapter 10 of the Fresno County Municipal Code. Short-term impacts would therefore be less than significant.

### 5.1.2 Long-Term Impacts

#### Traffic Noise

The expected trip generation for the project was determined by the Institute of Transportation Engineers Trip Generation Manual, 10<sup>th</sup> Edition. A total of 215 daily trips, 18 AM Peak hour trips and 20 PM peak hour trips are expected to be generated. Since, traffic volumes associated with the Project are very small, future development within the planning area will not result any significant impact at sensitive receptors in the study area and doesn't exceed the City of Fresno's Transportation Noise Source criteria. As a result, Project traffic will not create a significant impact at sensitive receptors in the study area. Implementation of the Project will not result in significant adverse impacts from traffic noise levels within the Project study area. Long-term impacts would therefore be less than significant.

#### Stationary Noise

Section 4.2 above indicates that none of the sensitive receivers will be impacted by off-site noise sources. The estimated maximum noise levels anticipated for the Project will not exceed the Fresno County Stationary Noise Source criteria. Impacts would be less than significant, and no mitigation is required.

## 5.2 Generation of excessive groundborne vibration or groundborne noise levels?

Ambient vibration levels in residential areas are typically 50 VdB, which is well below human perception. The operation of heating/air conditioning systems and slamming of doors produce

typical indoor vibrations that are noticeable to humans but not considered adverse or significant.

Construction activity can result in ground vibration, depending upon the types of equipment used and proximity to receptors. Operation of construction equipment causes ground vibrations, which spread through the ground and diminish in strength with distance from the source generating the vibration. Building structures that are founded on the soil in the vicinity of the construction site respond to these vibrations, with varied results. Ground vibrations as a result of typical construction activities very rarely reach vibration levels that will damage structures but can cause low rumbling sounds and detectable vibrations for buildings very close to the site. Construction activities that generally create the most severe vibrations are blasting and impact pile driving. Neither of these activities will be needed to construct the Project.

Vibration levels from various types of construction equipment are shown in Table 6. The primary concern with construction vibration is building damage. Therefore, construction vibration is generally assessed in terms of PPV. Using the highest vibration level shown in Table 6 (Lv 87), the anticipated vibration level at 100 feet, 150 feet, and 200 feet is 75, 71, and 69 VdB, respectively.

Construction activities associated with the Project would likely require the use of various types of equipment including bulldozers and dump trucks. Based on the vibration levels provided in Table 6, ground vibration generated by common construction equipment would be 75 VdB or less at a distance of 100 feet or more. The Project site is relatively flat and wouldn't generally require the use of a large bulldozer or caisson drilling. Because of the location of the Project site and the nearest residential units to the northeast (170 feet), it is not anticipated that construction of the Project would impact adjacent residential units. As a result, the anticipated vibration levels at the nearest off-site structures will not exceed vibration levels greater than 75 VdB. Therefore, impacts would be less than significant without mitigation.

### **5.3 For a project located within the vicinity of a private airstrip or an airport land use plan or, where such a plan has not been adopted, within two miles of a public airport or public use airport, would the project expose people residing or working in the project area to excessive noise levels?**

The Project is not located within the vicinity of a private airstrip or public use airport. The Fresno Yosemite International Airport and Sierra Sky Park Airport are located nearly 9 miles south and southwest of the Project, respectively. No impacts would occur.

**MEMORANDUM**

**GPA566;  
AA3850; TTM  
6420; VA4140**

**TO:** Austin Ewell, Ewell Group

**FROM:** Erik Ruehr, VRPA Technologies, Inc.

**DATE:** November 17, 2021

**RE:** Willow View Estates  
Vehicle Miles Traveled (VMT) Analysis

This memorandum provides a vehicle miles traveled (VMT) analysis for the proposed Willow View Estates project located near the intersection of Friant Road and Willow Avenue in Fresno County. The analysis was conducted to meet the requirements for transportation analysis under the California Environmental Quality Act (CEQA). The remainder of the memorandum includes sections describing background information, the project description, trip generation, VMT significance criteria, and VMT analysis.

**BACKGROUND INFORMATION**

Per the requirements of Senate Bill 743 (SB 743), VMT is the new performance measure used in CEQA transportation analysis. VMT became the required performance measure on July 1, 2020 replacing the previous performance measure which was level of service (LOS). The VMT generated by land development projects is compared to various screening criteria and significance thresholds to determine whether the level of VMT would be considered to be significant. Additional detail on this process is provided in the sections that follow.

**PROJECT DESCRIPTION**

The project is located along east of Friant Road and south of Willow Avenue. Exhibits 1 through 3 show the regional location, project location, and site plan. Plans call for development of 18 single-family residential units.

**TRIP GENERATION**

The expected trip generation for the project was determined by the Institute of Transportation Engineers Trip Generation Manual, 10<sup>th</sup> Edition. A total of 215 daily trips, 18 AM peak hour trips, and 20 PM peak hour trips are expected to be generated.



## **VMT SIGNIFICANCE CRITERIA**

The State of California Governor's Office of Planning and Research (OPR) document titled *Technical Advisory on Evaluating Transportation Impacts in CEQA* dated December 2018 (OPR Guidelines) indicates that projects generating fewer than 110 trips per day generally may be presumed to cause a less than significant transportation impact. This recommendation is considered to be apply in the absence of local data that would indicate a different threshold. Per CEQA, lead agencies are authorized to determine appropriate significance criteria and should be able to present substantial evidence for the significance criteria that they select.

The Fresno Council of Governments (Fresno COG) has completed a document titled *Fresno County SB 743 Implementation Regional Guidelines* dated January 2021 that presents substantial evidence that projects generating fewer than 500 trips per day may be presumed to cause a less than significant transportation impact (see pages 7 to 12). (Incidentally, this threshold is already utilized by the County of Fresno to determine whether a traffic impact study is required as described in Section 1.3 of the *Guidelines for the Preparation of Traffic Impact Studies Within County of Fresno* dated August 2012.)

## **VMT ANALYSIS**

The project is expected to generate 215 trips per day. Therefore, the Project is considered to cause a less than significant transportation impact per the Fresno COG guidelines. Project trips will be less than 500 per day and substantial evidence exists as presented by Fresno COG that projects generating less than 500 trips per day may be presumed to cause a less than significant transportation impact.

Please contact me if you have any questions. I can be reached by email at [eruehr@vrpatechnologies.com](mailto:eruehr@vrpatechnologies.com) or by phone at 858/361-7151.



# Willow View Estates Vehicle Miles Traveled Analysis

## Regional Location

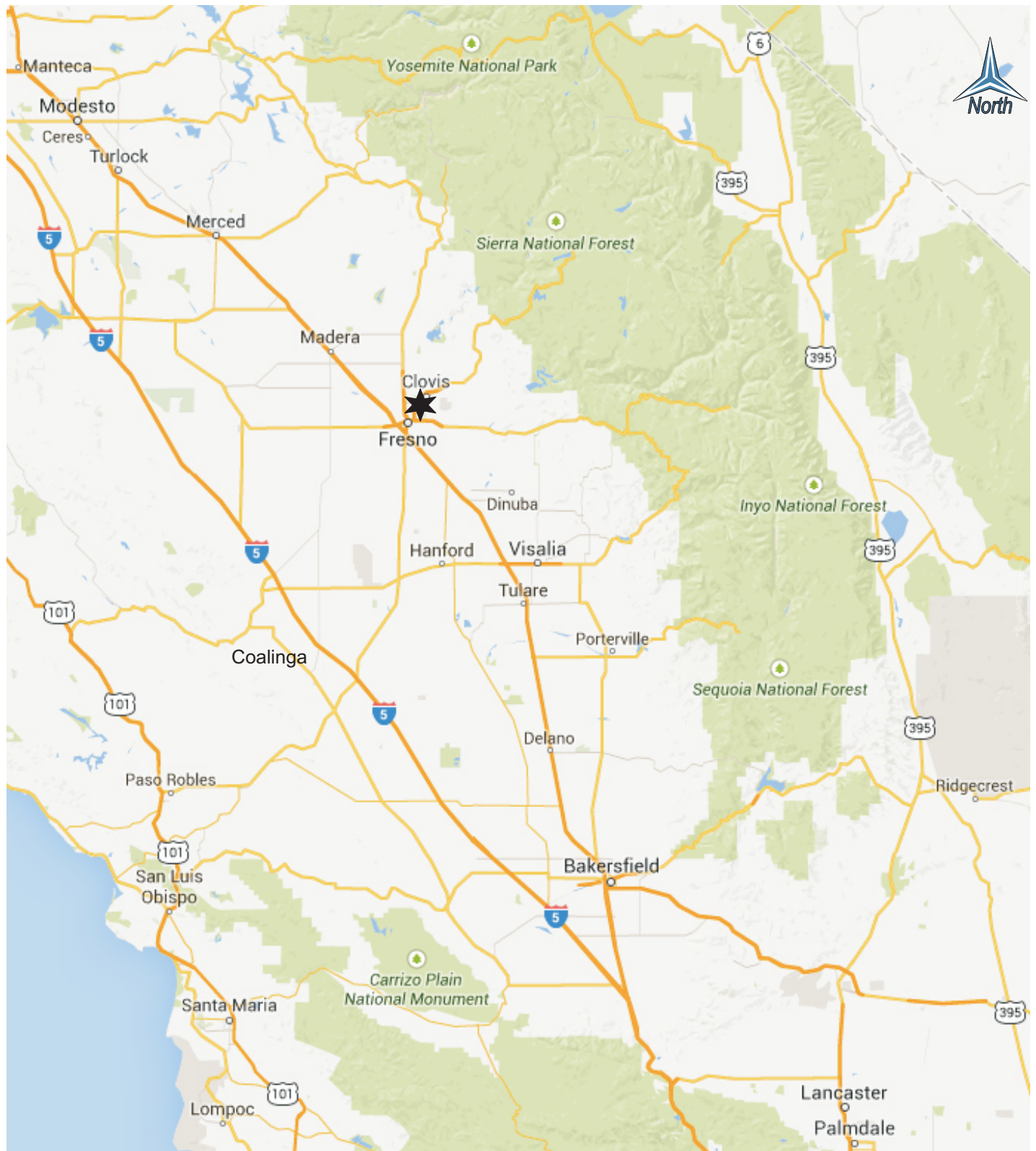

### LEGEND

★ Project Location

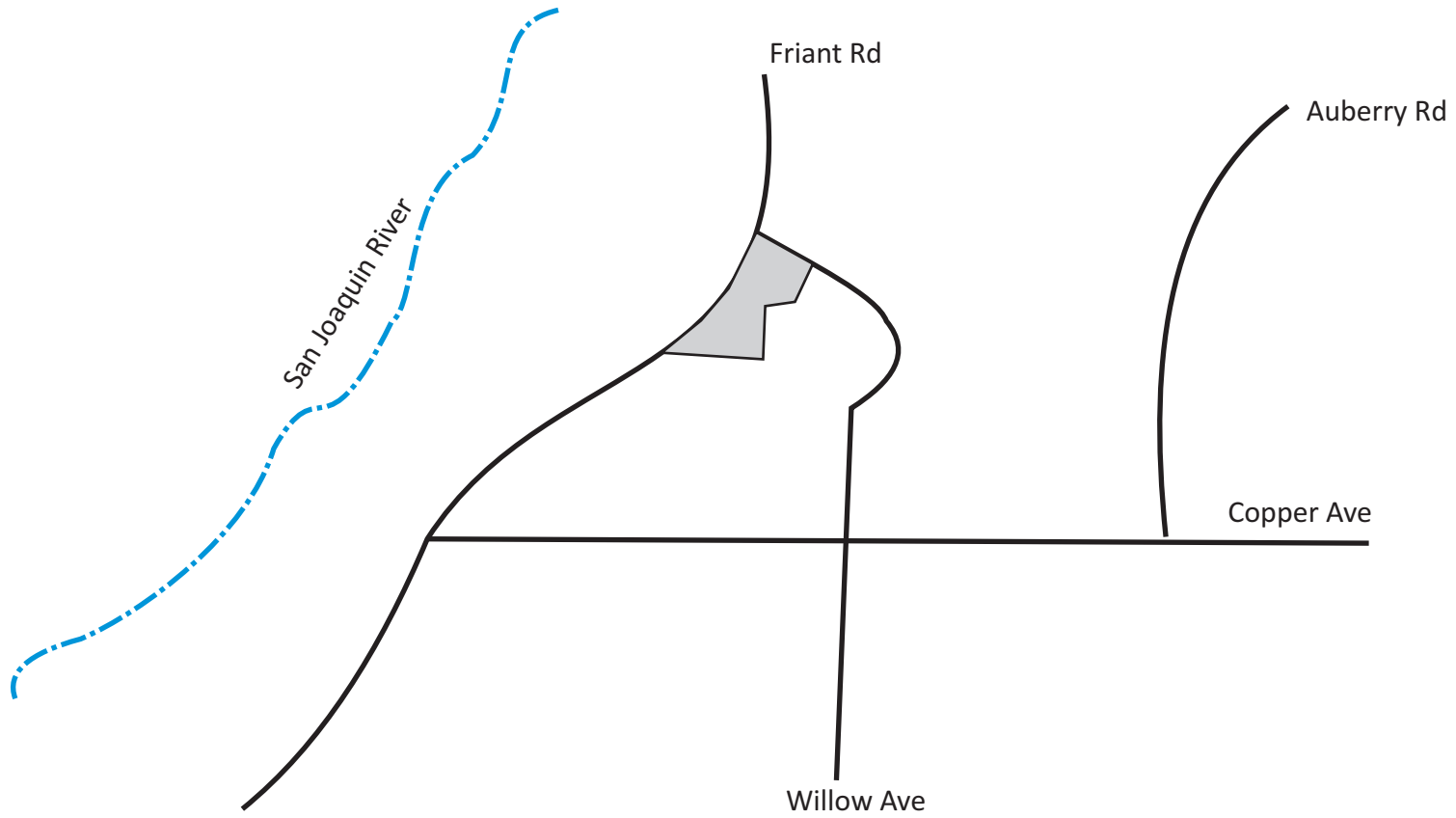

LEGEND	
	Project Location





Drawn by: Kevin Mahabadi  
Date: 01/18/2023